



# GTN Xi Series

## Pilot's Guide



## **COPYRIGHT & TRADEMARKS**

© 2019 Garmin International, Inc., or its subsidiaries. All rights reserved.

Except as expressly provided herein, no part of this manual may be reproduced, copied, transmitted, disseminated, downloaded or stored in any storage medium, for any purpose without the express prior written consent of Garmin. Garmin hereby grants permission to download a single copy of this manual and of any revision to this manual onto a hard drive or other electronic storage medium to be viewed and to print one copy of this manual or of any revision hereto, provided that such electronic or printed copy of this manual or revision must contain the complete text of this copyright notice and provided further that any unauthorized commercial distribution of this manual or any revision hereto is strictly prohibited.

Garmin<sup>®</sup>, FliteCharts<sup>®</sup>, and SafeTaxi<sup>®</sup> are registered trademarks of Garmin International or its subsidiaries. Connex<sup>™</sup>, Garmin Pilot<sup>™</sup>, Garmin SVT<sup>™</sup>, G3X Touch<sup>™</sup>, and Smart Airspace<sup>™</sup>, and Telligence<sup>™</sup> are trademarks of Garmin International or its subsidiaries. These trademarks may not be used without the express permission of Garmin.

The Bluetooth<sup>®</sup> word mark and logos are registered trademarks owned by Bluetooth SIG, Inc. and any use of such marks by Garmin is under license. Other trademarks and trade names are those of their respective owners.

Iridium<sup>®</sup> is a registered trademark of Iridium Communications, Inc. All rights reserved.

NavData<sup>®</sup> is a registered trademark of Jeppesen, Inc.

© 2019 SD<sup>®</sup> is a registered trademark of SD-3C, LLC. All rights reserved.

© 2019 SiriusXM Satellite Radio, Sirius, SXM, and all related marks and logos are trademarks of SiriusXM Radio Inc. All other marks and logos are property of their respective owners. All rights reserved.

SkyWatch<sup>®</sup> and Stormscope<sup>®</sup> are registered trademarks of L-3 Communications.

The term Wi-Fi<sup>®</sup> is a registered trademark of the Wi-Fi Alliance<sup>®</sup>.

All other marks and logos are property of their respective owners. All rights reserved.

## **SOFTWARE VERSION**

This manual reflects the operation of system software v20.00. Some differences in operation may be observed when comparing the information in this manual to later software versions.

## **INFORMATION & SUPPORT**

United States radar data provided by NOAA; European radar data collected and provided by Meteo France.

For information regarding the [Aviation Limited Warranty](#), refer to Garmin's website.

For aviation product support, visit [flyGarmin.com](http://flyGarmin.com).

<b>1 SYSTEM AT A GLANCE</b> .....	<b>1-1</b>
<b>Overview</b> .....	<b>1-2</b>
Unit Configurations .....	1-3
Apps & Features .....	1-4
<b>Pilot Interface</b> .....	<b>1-5</b>
Bezel .....	1-5
SD Card Slot .....	1-7
Touchscreen .....	1-8
Gestures .....	1-8
Keys .....	1-9
Menus .....	1-11
Tabs .....	1-12
Keypads .....	1-12
Screen Maintenance .....	1-14
Control Knobs .....	1-15
Knob Function Indicators .....	1-16
Screen Captures .....	1-16
Color Conventions .....	1-17
<b>Compatible Equipment</b> .....	<b>1-18</b>
Line Replaceable Units .....	1-18
<b>2 GET STARTED</b> .....	<b>2-1</b>
<b>Power Up</b> .....	<b>2-2</b>
Instrument Panel Self-Test .....	2-3
Preset Fuel Quantities .....	2-3
<b>Databases</b> .....	<b>2-5</b>
Database Effective Cycles .....	2-6
Active and Standby Databases .....	2-7
Database Info .....	2-7
Manual Updates .....	2-9
Database Updates Page .....	2-9
Automatic Updates .....	2-13
Database Concierge .....	2-15
Database SYNC .....	2-17
Chart Streaming .....	2-18
<b>Connectivity</b> .....	<b>2-19</b>
Connex Setup .....	2-19
Bluetooth Setup .....	2-20
Managing Paired Devices .....	2-21
Importing a Flight Plan .....	2-21
Wi-Fi Setup .....	2-22
<b>COM</b> .....	<b>2-23</b>
COM Standby Control Panel .....	2-23
COM Volume Controls .....	2-24
Open Squelch .....	2-24
COM Radio Setup .....	2-25
COM Channel Spacing Option .....	2-26
Reverse Frequency Look-up .....	2-27
Sidetone Volume Offset .....	2-28
Tuning & Monitoring .....	2-29

## Table of Contents

---

Direct Tuning .....	2-30
Transfer Frequency to Active (Flip-Flop) .....	2-32
Monitor Mode .....	2-33
Frequency Selection .....	2-34
Search Tabs .....	2-34
Remote Frequency Selection .....	2-35
Emergency Frequency .....	2-35
Create User Frequencies .....	2-36
COM Alert .....	2-38
Stuck Microphone .....	2-38
<b>NAV .....</b>	<b>2-39</b>
Frequency Tuning & Selection .....	2-39
<b>Audio Panel .....</b>	<b>2-41</b>
Audio Panel Controls .....	2-41
Mic Setup .....	2-43
3D Audio .....	2-43
MARKER Audio .....	2-44
Intercom .....	2-45
Intercom Modes .....	2-45
Intercom Setup .....	2-46
Music Setup .....	2-46
Telephone Setup .....	2-47
Bluetooth Audio .....	2-47
Telligence Voice Command .....	2-48
Voice Command Setup .....	2-49
<b>XPDR .....</b>	<b>2-50</b>
XPDR Control Panel .....	2-50
XPDR Setup .....	2-51
Enabling Extended Squitter Transmissions .....	2-51
Assigning a Flight ID .....	2-51
XPDR Modes .....	2-52
Squawk Code Keys .....	2-53
VFR .....	2-53
XPDR Key .....	2-53
XPDR Alert .....	2-55
<b>ADS-B Altitude Reporting .....</b>	<b>2-56</b>
ADS-B Control Panel .....	2-56
ADS-B Key .....	2-57
Enabling Anonymous Mode .....	2-57
Assigning a Flight ID .....	2-58
GDL 88 Alert .....	2-58
<b>Pilot Settings .....</b>	<b>2-59</b>
CDI Scale .....	2-60
Horizontal Alarm Limits .....	2-61
ILS CDI Capture .....	2-62
Keyboard Type .....	2-62
Airport Runway Criteria .....	2-63
Clocks & Timers .....	2-64
Timers .....	2-64

Clock .....	2-64
Alerts Settings .....	2-65
Arrival Alerts .....	2-65
Airspace Alerts .....	2-65
Unit Selections .....	2-66
User Selected NAV Angle .....	2-67
Position Formats .....	2-67
Click Volume .....	2-69
Click Volume Control .....	2-69
HTAWS Voice Alert Options .....	2-69
Display Brightness Control .....	2-70
Automatic Brightness Control .....	2-70
Manual Brightness Control .....	2-70
Scheduled Messages .....	2-71
Message Types .....	2-71
Modifying Scheduled Messages .....	2-71
Crossfill .....	2-72
GTN to GTN Data .....	2-72
GTN to GNS Data .....	2-73
<b>Status Indications .....</b>	<b>2-74</b>
Alert Types .....	2-74
Alert Annunciations .....	2-75
Pop-up Alerts .....	2-75
Aural Alerts .....	2-76
System Status .....	2-77
GPS Status .....	2-77
Circle of Uncertainty .....	2-79
SBAS Providers .....	2-80
GPS Status Annunciations .....	2-80
GPS Alerts .....	2-81
LRU Status .....	2-82
<b>Logs .....</b>	<b>2-83</b>
Export to SD Card .....	2-83
<b>3 NAVIGATION .....</b>	<b>3-1</b>
<b>Map .....</b>	<b>3-4</b>
Map Setup .....	3-8
Map Display Orientation .....	3-9
North Up Above .....	3-9
Visual Approach .....	3-10
Auto Zoom .....	3-11
Track Vector .....	3-12
Altitude Constraints .....	3-12
NAV Range Ring .....	3-13
Fuel Range Ring .....	3-13
TOPO Scale .....	3-14
Chart Color Scheme .....	3-14
Selected Altitude Range Arc .....	3-15
Aviation Selections .....	3-16
SafeTaxi .....	3-18

## Table of Contents

---

Airspace Selections .....	3-20
Smart Airspace .....	3-21
Land Selections .....	3-22
Traffic & Weather Selections .....	3-23
Map Interactions .....	3-24
Basic Interactions .....	3-24
Graphical Flight Plan Editing .....	3-27
Map Overlays .....	3-32
Overlay Controls .....	3-32
Overlay Status Icons .....	3-36
User Fields .....	3-37
Map Detail .....	3-41
<b>Charts .....</b>	<b>3-42</b>
Chart Setup .....	3-44
Chart Selection .....	3-45
Aircraft Position Icon .....	3-47
<b>Active Flight Plan .....</b>	<b>3-48</b>
Create a Flight Plan .....	3-51
Airway Options .....	3-52
Collapse All Airways .....	3-52
Sort Airways .....	3-53
En Route Vertical Navigation .....	3-54
Define a VNAV Profile .....	3-55
Altitude Constraints .....	3-56
VNAV Direct To .....	3-59
Transition to Approach .....	3-59
Temperature Compensated Altitude .....	3-60
OBS .....	3-61
Dead Reckoning .....	3-62
Parallel Track .....	3-63
Invert Flight Plan .....	3-65
Edit Data Fields .....	3-65
Flight Plan Catalog .....	3-66
Catalog Route Options .....	3-67
Flight Plan Waypoint Options .....	3-69
Import a Flight Plan .....	3-70
Import Options .....	3-70
Potential Import Errors .....	3-71
Along Track Offsets .....	3-71
Flight Plan Map Overlays .....	3-73
Leg Status Indications .....	3-73
Along Track Offset Indications .....	3-74
Altitude Constraint Labels .....	3-75
User Airport Icon .....	3-76
CDI .....	3-77
GPS Nav Status Bar .....	3-78
<b>Direct To .....</b>	<b>3-79</b>
Direct To Basics .....	3-79
Direct To Search Tabs .....	3-80

Direct To Activation .....	3-81
Navigating Direct To .....	3-83
Removing a Direct Course .....	3-84
User Holds .....	3-85
Hold at Waypoint Options .....	3-85
Search and Rescue Patterns .....	3-87
SAR Pattern Options .....	3-87
<b>Waypoints .....</b>	<b>3-89</b>
Waypoint Information .....	3-90
Common Page Features .....	3-91
Waypoint Specific Page Features .....	3-92
Waypoint Selection .....	3-94
Waypoint Autofill .....	3-94
FastFind Predictive Waypoint Entry .....	3-95
Search Tabs .....	3-96
Create User Waypoints .....	3-98
Define Waypoint Criteria .....	3-100
Create a User Waypoint .....	3-102
Edit an Existing User Waypoint .....	3-103
Delete User Waypoints .....	3-104
Import User Waypoints .....	3-105
Nearest .....	3-107
<b>Procedures .....</b>	<b>3-109</b>
Flight Procedure Basics .....	3-110
Localizer or VOR-based Approaches .....	3-112
GPS Flight Phase Annunciations .....	3-113
Departures .....	3-115
Flight Plan Departure Options .....	3-115
Arrivals .....	3-116
Flight Plan Arrival Options .....	3-116
Approaches .....	3-117
Flight Plan Approach Options .....	3-119
Missed Approach .....	3-120
Approach Hold .....	3-122
DME Arc .....	3-124
RF Legs .....	3-125
Vectors to Final .....	3-125
ILS Approach .....	3-126
RNAV Approaches .....	3-126
Visual Approach .....	3-133
Autopilot Outputs .....	3-135
<b>4 PLANNING .....</b>	<b>4-1</b>
<b>VCALC .....</b>	<b>4-4</b>
Define a VCALC Profile .....	4-4
VCALC Setup .....	4-6
<b>Trip Planning .....</b>	<b>4-7</b>
Trip Planning Modes .....	4-7
Trip Statistics .....	4-9
<b>Fuel Planning .....</b>	<b>4-11</b>

## Table of Contents

---

Fuel Planning Modes .....	4-11
Fuel Statistics .....	4-13
<b>DALT/TAS/Wind Calculator .....</b>	<b>4-15</b>
Edit Input Data .....	4-16
DALT/TAS/Wind Statistics .....	4-17
<b>RAIM Prediction .....</b>	<b>4-18</b>
Calculate RAIM Status .....	4-19
<b>Checklists .....</b>	<b>4-20</b>
View a Checklist .....	4-21
<b>5 HAZARD AWARENESS .....</b>	<b>5-1</b>
<b>Weather Awareness .....</b>	<b>5-3</b>
Datalink Weather .....	5-3
WX Info Banner .....	5-5
WX Display Orientation .....	5-5
Datalink Weather Products .....	5-6
Product Age .....	5-8
Product Legends .....	5-10
Altitude Adjustment Keys .....	5-10
Airport Icons .....	5-10
Precipitation .....	5-11
Textual AIRMETs .....	5-15
Graphical AIRMETs .....	5-16
AIREPs .....	5-18
Cell Movements .....	5-19
Center Weather Advisory .....	5-20
City Forecast .....	5-20
Clouds .....	5-21
County Warnings .....	5-22
Cyclone .....	5-22
Echo Tops .....	5-23
Freezing Levels .....	5-23
Icing .....	5-24
Lightning .....	5-26
METARs and TAFs .....	5-27
PIREPs .....	5-28
SIGMETs .....	5-29
Surface Analysis .....	5-29
TFRs .....	5-30
Turbulence .....	5-31
Winds Aloft .....	5-32
SiriusXM Weather .....	5-34
Activating SiriusXM Services .....	5-34
SiriusXM Weather Setup .....	5-36
FIS-B Weather .....	5-37
Data Transmission Limitations .....	5-37
FIS-B Product Status .....	5-39
FIS-B Weather Setup .....	5-40
Raw Text Reports .....	5-41
FIS-B Ground Reception Status .....	5-43

Connex Weather .....	5-44
Activate Connex Satellite Services .....	5-44
Deactivate Connex Unit Registration .....	5-45
Connex Weather Setup .....	5-46
Connex Data Requests .....	5-47
Stormscope .....	5-49
Stormscope Setup .....	5-50
Stormscope Modes & Symbols .....	5-50
Strike Rate .....	5-51
Views .....	5-51
Airborne Weather Radar .....	5-53
Weather Radar Setup .....	5-56
Radar Modes .....	5-60
Radar Controls .....	5-63
Radar Alerts .....	5-67
<b>Traffic Awareness .....</b>	<b>5-69</b>
Traffic Display .....	5-70
Traffic Setup .....	5-74
Traffic Test .....	5-74
Altitude Filtering .....	5-74
Traffic Interactions .....	5-75
Traffic Types .....	5-76
TIS-A .....	5-76
TCAD 9900B .....	5-78
TCAD 9900BX .....	5-80
Ryan TCAD 9900BX with GDL 88 .....	5-81
TAS/TCAS I .....	5-83
TCAS II .....	5-85
ADS-B .....	5-89
Traffic Alerting .....	5-95
Mute Alert .....	5-95
Alerting Parameters .....	5-96
<b>Terrain Awareness .....</b>	<b>5-97</b>
Terrain Configurations .....	5-97
GPS Altitude for Terrain .....	5-98
Database Limitations .....	5-99
Terrain Display .....	5-100
Terrain Setup .....	5-102
Terrain Proximity .....	5-104
Terrain Elevation Depictions .....	5-104
Obstacle Elevation Depictions .....	5-105
Alert Types .....	5-106
Alerting Thresholds .....	5-109
Overriding Flaps-based FIT alerting .....	5-114
Terrain Alerting .....	5-116
Inhibiting TAWS and Terrain Alerting Alerts .....	5-120
TAWS-B .....	5-121
TAWS-A .....	5-127
HTAWS/(H)Terrain Alerting .....	5-140

## Table of Contents

HTAWS Alerts .....	5-143
<b>6 SERVICES .....</b>	<b>6-1</b>
<b>SiriusXM Audio Entertainment .....</b>	<b>6-3</b>
SiriusXM Audio Activation .....	6-4
Adjust Radio Volume .....	6-5
Direct Channel Tuning .....	6-5
Browse Music Channels .....	6-6
Assign Channel Presets .....	6-7
XM Data Link Failure .....	6-8
<b>Connex Services .....</b>	<b>6-9</b>
Phone .....	6-9
Phone Volume .....	6-11
Phone Status Annunciations .....	6-11
Suppress Visuals .....	6-12
In-Call Distribution .....	6-12
Outgoing Calls .....	6-13
Incoming Calls .....	6-14
SMS Text .....	6-15
Message Filtering & Setup Options .....	6-16
Send a Text Message .....	6-17
Receiving Text Messages .....	6-19
Position Reports .....	6-20
Position Reporting Status Annunciations .....	6-20
Counters & Timers .....	6-21
Position Reporting .....	6-21
Contacts .....	6-22
Create a Contact .....	6-22
Find a Contact .....	6-23
Contact Options .....	6-23
<b>7 MESSAGES .....</b>	<b>7-1</b>
<b>Advisory Messages .....</b>	<b>7-2</b>
Message Key .....	7-3
Airspace Advisories .....	7-3
Database Advisories .....	7-4
Datalink Advisories .....	7-6
Flight Plan Advisories .....	7-9
GPS/WAAS Advisories .....	7-11
Navigation Advisories .....	7-12
Pilot Specified Advisories .....	7-15
System Hardware Advisories .....	7-16
Audio Panel Advisories .....	7-20
COM Radio Advisories .....	7-21
XPDR Advisories .....	7-23
Terrain Advisories .....	7-24
Traffic System Advisories .....	7-25
VCALC Advisories .....	7-26
VLOC/GS Advisories .....	7-27
Waypoint Advisories .....	7-28
Weather Service Advisories .....	7-29

<b>8 QUALIFICATION</b> .....	<b>8-1</b>
<b>Glove Qualification</b> .....	<b>8-2</b>
<b>Voice Command Qualification</b> .....	<b>8-6</b>
<b>9 PRACTICE</b> .....	<b>9-1</b>
<b>Demo Mode</b> .....	<b>9-2</b>
Enable Demo Mode .....	9-2
Demo Setup Options .....	9-3
Advanced Settings .....	9-4
<b>10 GLOSSARY</b> .....	<b>10-1</b>
<b>11 REGULATORY INFORMATION</b> .....	<b>11-1</b>
<b>Compliance</b> .....	<b>11-2</b>
FCC Compliance Statement .....	11-2
AC 90-100A .....	
Statement of Compliance .....	11-2
<b>Software License Agreement</b> .....	<b>11-3</b>

INTENTIONALLY LEFT BLANK

**WARNING**

*Do not use terrain avoidance displays as the sole source of information for maintaining separation from terrain and obstacles. Garmin obtains terrain and obstacle data from third party sources and cannot independently verify the accuracy of the information.*

**WARNING**

*Do not rely solely upon Terrain Proximity data for terrain avoidance. Terrain Proximity is not a certified terrain awareness system. It is an aid to situational awareness only. Using Terrain Proximity data does not under any circumstances or conditions relieve the pilot's responsibility to see and avoid terrain or obstacles.*

**WARNING**

*Do not use TAWS information for primary terrain or obstacle avoidance. TAWS is intended only to enhance situational awareness.*

**WARNING**

*Always refer to current aeronautical charts and NOTAMs for verification of displayed aeronautical information. Displayed aeronautical data may not incorporate the latest NOTAM information.*

**WARNING**

*Never use GPS altitude for vertical navigation, traffic avoidance, or compliance with any air traffic control clearance. The altitude calculated by GPS receivers is geometric height above Mean Sea Level and may vary significantly from the altitude displayed on the primary barometric altimeter. The barometric altimeter must be used to comply with all air traffic control clearances.*

**WARNING**

*Never use expired databases. Update databases regularly to ensure currency. Use out of date database information at your own risk.*



### **WARNING**

*Never use basemap information (land and water data) as the sole means of navigation. Basemap data is intended only to supplement other approved navigation data sources and should be considered only an aid to enhance situational awareness.*



### **WARNING**

*Do not rely solely upon the display of traffic information to accurately depict all of the traffic within range of the aircraft. Due to lack of equipment, poor signal reception, and/or inaccurate information from aircraft or ground stations, traffic may be present that is not represented on the display.*



### **WARNING**

*Do not rely solely upon the display of traffic information for collision avoidance maneuvering. The traffic display does not provide collision avoidance resolution advisories and does not under any circumstances or conditions relieve the pilot's responsibility to see and avoid other aircraft.*



### **WARNING**

*Never use datalink weather information for maneuvering in, near, or around areas of hazardous weather. Information contained within datalink weather products may not accurately depict current weather conditions.*



### **WARNING**

*Never use datalink weather information for entering a thunderstorm. Per the FAA's Aeronautical Information Manual (AIM) and AC 00-24C: "avoid by at least 20 miles any thunderstorm identified as severe or giving an intense radar echo."*



### **WARNING**

*Do not use the indicated datalink weather product age to determine the age of the weather information shown by the datalink weather product. Due to time delays inherent in gathering and processing weather data for datalink transmission, the weather information shown by the datalink weather product may be older than the indicated weather product age.*



### **WARNING**

*Do not rely solely upon Datalink services to provide TFR information. Always confirm TFR information through official sources such as flight service stations or air traffic control.*

**WARNING**

*Do not rely on information from a lightning detection system display as the sole basis for hazardous weather avoidance. Range limitations and interference may cause the system to display inaccurate or incomplete information. Refer to documentation from the lightning detection system manufacturer for detailed information about the system.*

**WARNING**

*Always refer to current aeronautical charts for appropriate minimum clearance altitudes. The displayed MSAs are only advisory in nature and should not be relied upon as the sole source of obstacle and terrain avoidance information.*

**WARNING**

*Do not use GPS to navigate to any active waypoint identified as a "NON WGS84 WPT" by a system message. "NON WGS84 WPT" waypoints are derived from an unknown map reference datum that may be incompatible with the map reference datum used by GPS (known as WGS84) and may be positioned in error as displayed.*

**WARNING**

*Do not learn operational procedures for this product in the air. For safety reasons, thoroughly practice basic operation of this product on the ground before use during flight.*

**WARNING**

*Review and understand all aspects of this pilot's guide. Doing so reduces the risk of unsafe operation.*

**WARNING**

*Always resolve any discrepancies between the display and other navigation sources when they occur. During flight operations, compare display indications to information from other NAVAIDs, visual sightings, charts, and other available sources before continuing navigation.*

**WARNING**

*Be aware that this product, its packaging, and its components contain chemicals known to the State of California to cause cancer, birth defects, or reproductive harm. This notice is being provided in accordance with California's Proposition 65. If you have any questions or would like additional information, please refer to our website at [www.garmin.com/prop65](http://www.garmin.com/prop65).*



### CAUTION

*Do not clean display surfaces with abrasive cloths or cleaners containing ammonia. They will harm the anti-reflective coating. Use a clean, lint-free cloth and anti-reflective lens cleaner.*



### CAUTION

*Ensure that any unit repairs are made by an authorized Garmin service center. Unauthorized repairs or modifications could void both the warranty and affect the airworthiness of the aircraft.*



### NOTE

*The unit may not respond to touch commands if condensation or moisture accumulate on the touchscreen.*



### NOTE

*The COM application supports channel tuning for both 8.33 kHz and 25 kHz channels within radio-frequency range. If flying in a region where 8.33 kHz channel spacing is available, set the COM radio to 8.33 kHz to prevent the loss of any stored or recently used frequencies.*



### NOTE

*The COM transceiver antenna(s) of the equipment mount along the fuselage and are accessible only to aircraft maintenance personnel.*



### NOTE

*All visual depictions contained within this document, including screen images of the system panel and displays, are subject to change and may not reflect the most current system software and aviation databases. Depictions of equipment may differ slightly from the actual equipment. Feature depictions may differ from actual unit features depending on configuration.*



### NOTE

*The United States government operates the Global Positioning System and is solely responsible for its accuracy and maintenance. The GPS system is subject to changes which could affect the accuracy and performance of all GPS equipment. Portions of the system utilize GPS as a precision electronic NAVAID. Therefore, as with all NAVAIDS, information presented by the system can be misused or misinterpreted and, therefore, become unsafe.*



### NOTE

*This device complies with part 15 of the FCC Rules. Operation is subject to the following two conditions: (1) this device may not cause harmful interference, and (2) this device must accept any interference received, including interference that may cause undesired operation.*



### NOTE

*Interference from GPS repeaters operating inside nearby hangars can cause an intermittent loss of attitude and heading displays while the aircraft is on the ground. Moving the aircraft more than 100 yards away from the source of the interference should alleviate the condition.*



### NOTE

*Use of polarized eye wear may cause the flight displays to appear dim or blank.*



### NOTE

*Canadian installations: In accordance with Canadian Radio Specifications Standard 102 (RSS 102), RF field strength exposure to persons from an antenna connected to this device should be limited to 60 V/m for controlled environment and 28 V/m for uncontrolled environment.*



### NOTE

*Do not use SafeTaxi or ChartView as the basis for ground maneuvering. These functions do not comply with the requirements of AC 120-76C and are not qualified for use as an airport moving map display. They should be used for orientation purposes only.*



### NOTE

The FAA has asked Garmin to remind pilots who fly with Garmin database-dependent avionics of the following:

- It is the pilot's responsibility to remain familiar with all FAA regulatory and advisory guidance and information related to the use of databases in the National Airspace System.
- Garmin equipment will only recognize and use databases that are obtained from Garmin or Jeppesen. Databases obtained from Garmin or Jeppesen that have a Type 2 LOA from the FAA are assured compliance with all data quality requirements (DQRs). A copy of the Type 2 LOA is available for each applicable database and can be viewed at [flyGarmin.com](http://flyGarmin.com) by selecting "Aviation Database Declarations."
- Use of a current Garmin or Jeppesen database in your Garmin equipment is required for compliance with established FAA regulatory guidance, but does not constitute authorization to fly any and all terminal procedures that may be presented by the system. It is the pilot's responsibility to operate in accordance with established AFM(S) and regulatory guidance or limitations as applicable to the pilot, the aircraft, and installed equipment.



### NOTE

The pilot/operator must review and be familiar with Garmin's database exclusions list, as discussed in SAIB CE-14-04, to determine what data may be incomplete. Visit [flyGarmin.com](http://flyGarmin.com) and select "Database Exclusions List."



### NOTE

The pilot/operator must have access to Garmin and Jeppesen database alerts and consider their impact on the intended aircraft operation. To view these alerts, visit [flyGarmin.com](http://flyGarmin.com) and select "Aviation Database Alerts."



### NOTE

Contact Garmin Product Support if you want or need to adjust the database.



### NOTE

Garmin requests the flight crew report any observed discrepancies related to database information. These discrepancies could come in the form of an incorrect procedure; incorrectly identified terrain, obstacles and fixes; or any other displayed item used for navigation or communication in the air or on the ground. Visit [flyGarmin.com](http://flyGarmin.com) and select "Aviation Data Error Report."



### **NOTE**

*Information obtained solely through FIS-B does not replace a thorough preflight briefing. NOTAMs received via FIS-B uplink may not be a complete listing. Active NOTAMs are removed from the FIS-B data stream 30 days after issuance. FIS-B uplink is not an FAA approved source for NOTAMs.*



### **NOTE**

*When using Stormscope, there are several atmospheric phenomena in addition to nearby thunderstorms that can cause isolated discharge points in the strike display mode. However, clusters of two or more discharge points in the strike display mode do indicate thunderstorm activity if these points reappear after the screen has been cleared.*



### **NOTE**

*This navigation unit has a very high degree of functional integrity. However, the pilot must realize that providing monitoring and/or self-test capability for all conceivable system failures is not practical. Although unlikely, it may be possible for erroneous operation to occur without fault indication. It is the responsibility of the pilot to detect such occurrences by cross-checking with all redundant or correlated information available in the cockpit.*

### Record of Revision

REVISION	DATE	CHANGE DESCRIPTION
A	11.20.19	Initial Release.
B	12.06.19	Production Release.

### Layout

SECTION	TITLE
1	System at a Glance
2	Get Started
3	Navigation
4	Planning
5	Hazard Awareness
6	Services
7	Messages
8	Qualification
9	Practice
10	Glossary
11	Regulatory Information

The design and layout of this guide is intended to provide clear, concise sections written in the logical order of a pilot's flight instrument and systems scan.

### Electronic Document Features

Versions of this guide are saved in Adobe Acrobat and are available for download at: [garmin.com/manuals](http://garmin.com/manuals)

## Product Descriptions

This guide covers the operation of the following Garmin product series.

GTN 650Xi Series

GTN 750Xi Series

When you see	It means
a product name in bold (e.g., <b>GTN 750Xi</b> )	the information pertains to that specific model only
a reference to a product series (e.g., GTN 650Xi Series)	the information pertains to all models listed within that series (e.g., GTN 625Xi/635Xi/650Xi)
product names separated by a forward slash (e.g., GTN 635Xi/650Xi or GTN 650Xi/750Xi)	the information pertains to both products

### GTN 650Xi Series

- GTN 625Xi
- GTN 635Xi
- GTN 650Xi

### GTN 750Xi Series

- GTN 725Xi
- GTN 750Xi

Unless otherwise stated, information pertaining to the GTN Xi Series is applicable to all 650Xi and 750Xi series navigators.

## Feature Depictions

Except for cases when operational differences dictate, the GTN 750Xi display is shown as typical.

### Special Notations

This guide uses the following message types when applicable.



#### **WARNING**

*Indicates when serious injury or death will occur.*



#### **CAUTION**

*Indicates when equipment damage is possible.*



#### **NOTE**

*Emphasizes a point about a specific feature, function, or operation.*

#### **Insets**

These boxes may include a list of features or application functions, references to additional information, or a useful pilot's tip.

## Reference Manuals

DOCUMENT	P/N
GDL 69/69A SiriusXM Satellite Radio Activation Instructions	190-00355-04
GDL 84/88 ADS-B Transceiver Pilot's Guide	190-01122-03
GTX 335/345 All-In-One ADS-B Transponder Pilot's Guide	190-01499-00
Telligence Voice Command Guide	190-01007-50

## Reference Websites

WEBSITE	ADDRESS
Aviation Limited Warranty	<a href="https://www.garmin.com/en-US/legal/aviation-limited-warranty">https://www.garmin.com/en-US/legal/aviation-limited-warranty</a>
Database Concierge	Go to <a href="http://www.flygarmin.com/support">http://www.flygarmin.com/support</a> and select Database Management.
ADS-B Academy	<a href="https://www.garmin.com/us/intheair/ads-b">https://www.garmin.com/us/intheair/ads-b</a>
Connex	<a href="http://www.garmin.com/connex">http://www.garmin.com/connex</a>
FAA Regulatory and Guidance Library	<a href="https://rgl.faa.gov">https://rgl.faa.gov</a>

INTENTIONALLY LEFT BLANK

# 1 System at a Glance

OVERVIEW.....	1-2
PILOT INTERFACE .....	1-5
COMPATIBLE EQUIPMENT.....	1-18

# Overview

Two series of panel mount navigators comprise the GTN Xi Series. The primary difference between these displays is the size of the screen.



## **4.9" GTN 650Xi Series**

GTN 625Xi  
GTN 635Xi  
GTN 650Xi

## **6.9" GTN 750Xi Series**

GTN 725Xi  
GTN 750Xi

Due to its large-format display, the GTN 750Xi Series comes loaded with terminal procedure charts, including departure, arrival, and approach plates.

# Unit Configurations

GTN 625Xi

**GPS/MFD**

GTN 635Xi

**GPS/MFD/COM**

GTN 650Xi

**GPS/MFD/COM/NAV**

GTN 725Xi

**GPS/MFD**

GTN 750Xi

**GPS/MFD/COM/NAV**

## COMPARISON TABLE

GTN Xi	GPS/MFD	COM Radio	NAV Radio	Chart Display	Weather Radar	Remote Audio Panel
625	•					
635	•	•				
650	•	•	•			
725	•			•	•	•
750	•	•	•	•	•	•

# Apps & Features

COMMON FEATURES
Airways
Arrivals
Approaches
CDI
Checklists
Database Concierge Access <sup>†</sup>
Datalink Weather <sup>‡</sup>
Departures
Flight Plan
Graphical Flight Planning
Iridium Phone/SMS <sup>‡</sup>
Moving Map
Waypoints (includes user-generated and nearest waypoint info)
Remote Transponder Control <sup>‡</sup>
SafeTaxi
SiriusXM Music <sup>‡</sup>
Stormscope <sup>‡</sup>
TAWS/HTAWS <sup>‡</sup>
Telligence Voice Command <sup>‡</sup>
Traffic <sup>‡</sup>
VNAV Descent <sup>‡</sup>

While features vary depending on model and unit configuration, all models share many of the same features.

<sup>†</sup> Requires Wi-Fi connection via Flight Stream 510.

<sup>‡</sup> Optional. Function availability dependent upon aircraft interfaces or enablement.

# Pilot Interface

## Bezel

The bezel provides a combination of mechanical knobs and push-keys. Active touch areas on the display screen allow access to unit features and apps.

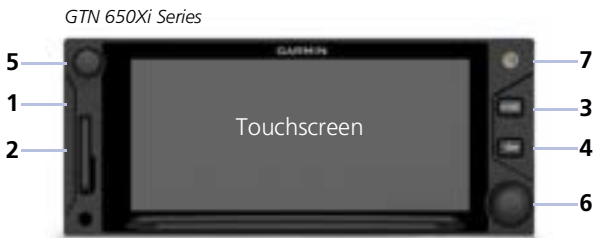

### 1 Bezel

Ledges provide hand stability when performing data entry and making selections.

### 2 SD Card Slot

Interface for loading database, exporting log files, and updating software. Compatibility with Flight Stream 510 allows wireless database transfer from the Garmin Pilot app via Database Concierge.

### 3 Home Key

Provides direct access to the Home page.

### 4 Direct To Key

Opens the Direct To function for immediate course setting.

### 5 Volume/Squelch Knob

Allows audio volume adjustment for the active COM radio, NAV receiver, or connected external audio panel. COM squelch and NAV ident functionality accessible via knob push.

### 6 Inner & Outer Knobs

Multipurpose dual concentric knob allows data entry, list scrolling, map range control, page navigation, and NAV/COM frequency tuning.

### 7 Photocell

Measures cockpit ambient light level to automatically adjust display brightness for day and night.



### Home Key Shortcuts

**GTN 650Xi Series:** Pushing and holding the Home key on these units provides direct access to Default Navigation features.

**GTN 750Xi Series:** Pushing and holding the Home key on these units provides direct access to the moving map.

# SD Card Slot



## NOTE

*Do not remove or insert an SD card while in flight. Always verify the system is powered off before inserting or removing an SD card.*

### FEATURE LIMITATIONS

- SD card in the FAT32 format, with memory capacity between 8 GB and 32 GB

The navigator requires an SD card for the following tasks.

- Exporting data logs
- Capturing screen images
- Upgrading software
- Enabling Flight Stream connectivity
- Updating databases

## INSERT AN SD CARD

When inserting an SD card:

1. Verify unit power is off and the slot is empty.
2. Hold card such that label faces left edge of display screen.
3. Ensure back edge of card is flush with display bezel after insertion.

## EJECT AN SD CARD

1. Power off the unit.
2. Release the spring latch by pressing lightly on exposed edge of card.

# Touchscreen

A multi-touch color display provides onscreen controls for unit operation.

## Gestures

### TAP



Touching the screen briefly with a single finger.

Use this gesture for:

- Opening a page or menu
- Activating a command key or data entry field
- Displaying map feature information
- Selecting an option within an application

### TAP AND HOLD



Certain momentary controls (e.g., directional arrow keys) provide a secondary tap and hold function. Tap the key and hold your finger in place until the desired action occurs.

Use this gesture for:

- Scrolling with arrow keys
- Increasing/decreasing values continuously

### SWIPE



A smooth motion that involves touching an object, then sliding your finger across the screen and lifting up.

Use this gesture for:

- Accessing multiple panes (right or left swipes)
- Viewing and scrolling lists
- Panning across a map display

### FLICK



Swiping the screen in a quick upward or downward motion. Information moves at a fast speed (faster than if holding the arrow key), then slows to a stop.

Use this gesture for scrolling an item list.

### PINCH & STRETCH



Touch any map with two fingers at the same time, then bring the fingers close together (pinch) or spread them apart (stretch). Just remember: stretch to zoom in and pinch to zoom out.

Use this gesture for magnifying map features.

# Keys

## COMMON COMMANDS



Open the system messages list.  
A flashing icon indicates unread messages.



Open a context menu.



Cancel an active function without inputting data.



Return to the previous page.



Select the corresponding item (e.g., database update).  
A checkmark confirms selection.

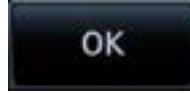

Confirm the requested action (e.g., removing a flight plan waypoint)



Move the cursor back a single space at a time.



Input a specified value.



### Zoom Control & Scale

Change the current magnification by tapping **In** or **Out**.



### Directional Keys

Increment or decrement setting values by tapping these directional keys. Tap and hold to increase or decrease the value continuously.

## FUNCTION KEYS

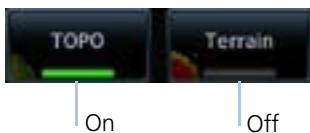

Toggle keys turn a specific function on or off. The current state of the function is indicated below the key label.

## APP ICONS

Tapping one of these icons opens the corresponding application. Some apps provide additional icons for accessing functions on subpages (e.g., System, Utilities).

### Home Page Apps<sup>†</sup>

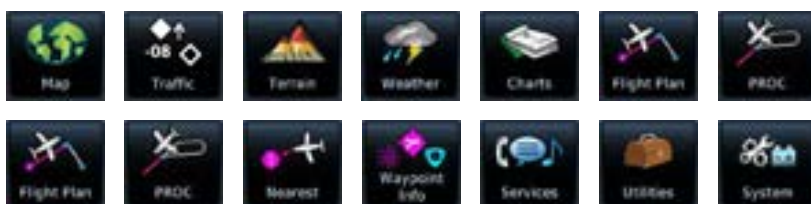

<sup>†</sup> Actual icons dependent upon model type and configuration.

## Optional Apps

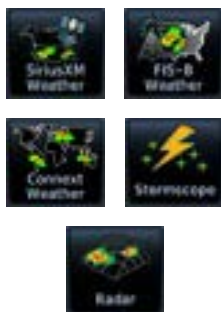

Additional icons are available when certain optional features are installed and the associated functions are enabled (e.g., Music, Phone, SXM Weather).

## Menus

Menu group related controls into an expandable pane, allowing access to multiple functions on a single page. Depending on the number of available functions, a menu may comprise more than one pane.

### POP-UP MENU



Pop-up menu open to the default or previously selected value.

Default or Current Setting

### SLIDE OVER MENUS

These menus slide out from the bottom or sides of the display when an object or menu item is selected on the underlying page.



Underlying Page Hidden

### LISTS

Scrollable lists group control keys related to a single function (e.g., selectable range options). Toggle keys either enable or disable list items.



Scroll Bar

In some cases, **Settings** or **Range** keys provide access to selectable setting options.

When scrolling, all keys in the list are inactive.

## Tabs

Tabs group information into individual panes. Content includes scrolling lists, data fields, function keys, or a combination of controls.

Tabs are located along the left and right sides of a pane.



## Keypads

The navigator employs multiple keypad types to serve specific settings and functions.

*Keypad types, GTN 750Xi Series*

Numeric keypads open on a single pane.

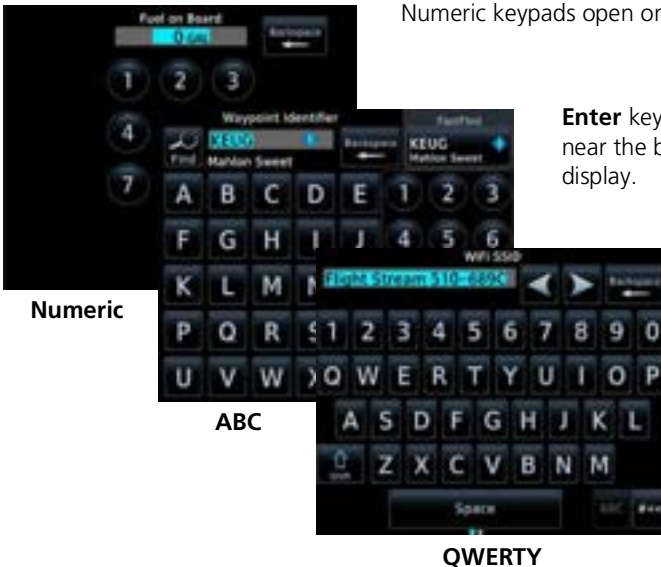

**Enter** keys always appear near the bottom of the display.

## GTN 650Xi SERIES

Alphanumeric keypads comprise multiple keysets that are accessible by way of swipe or key selection.

*ABC keysets, GTN 650Xi Series*



Selectable Keysets



Active Keyset

An indicator shows which keyset is active. Keys **A** through **M** are active by default.

For convenience, GTN 650Xi Series navigators provide a slider, allowing you to quickly select a group of five keys at any given time.

*Slider, GTN 650Xi Series*



Swiping the key selector left or right scrolls through all available keys.

Active Selection

Key Selector

## Screen Maintenance



Tapping **Clean Screen** places the touch screen in an inactive state for cleaning purposes.



### CAUTION

*Do not clean display surfaces with abrasive cloths or cleaners containing ammonia. They will harm the anti-reflective coating. Use a clean, lint-free cloth and anti-reflective lens cleaner.*

### WHERE TO FIND IT



Use care when cleaning the touchscreen and front bezel. Avoid scratching the surface of the display.

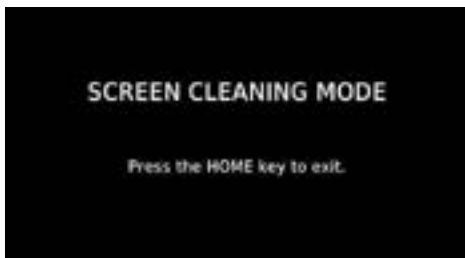

To exit screen cleaning mode, push the **Home** key.

# Control Knobs

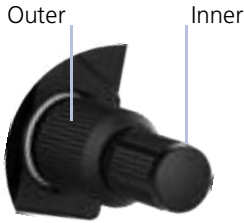

## Dual Concentric Knob

Inner and outer control knobs offer an alternative method for selecting and modifying data without the use of touch keys.



## Volume/Squelch Knob

A single volume knob controls audio volume for the selected COM radio, NAV receiver, and/or external audio input devices (e.g., remote audio panel).

Depending on configuration, pushing these knobs momentarily performs additional XPDR, COM, and/or NAV related functions.

### VOLUME/SQUELCH KNOB FUNCTIONS

- |                    |   |
|--------------------|---|
| <b>Knob (Turn)</b> | <ul style="list-style-type: none"> <li>Adjusting COM radio volume<sup>†</sup></li> <li>Adjusting NAV radio volume<sup>‡</sup></li> </ul>  |
| <b>Knob (Push)</b> | <ul style="list-style-type: none"> <li>Disabling the COM automatic squelch function<sup>†</sup></li> <li>Enabling/disabling the ident tone for the NAV radio<sup>‡</sup></li> </ul> |

### DUAL CONCENTRIC KNOB FUNCTIONS

- |                          |  |
|--------------------------|--|
| <b>Outer Knob</b>        | <ul style="list-style-type: none"> <li>Moving cursor forward or backward within data field</li> <li>Tuning major frequency digits<sup>†</sup></li> </ul>   |
| <b>Inner Knob (Turn)</b> | <ul style="list-style-type: none"> <li>Modifying individual characters in data entry field</li> <li>Tuning minor frequency digits<sup>†</sup></li> </ul>   |
| <b>Inner Knob (Push)</b> | <ul style="list-style-type: none"> <li>Entering current or specified numerical value</li> <li>Toggling between COM and NAV radio functions<sup>‡</sup></li> <li>Enabling active/standby frequency flip-flop<sup>†</sup></li> </ul> |

<sup>†</sup> GTN 635Xi/GTN 650Xi/GTN 750Xi only.

<sup>‡</sup> GTN 650Xi/GTN 750Xi only.

# Knob Function Indicators

Available dual concentric knob functions announce at the bottom of the display.

### Default State

Com Freq / Psh Nav ▶

Available functions:

- Set knob focus to standby frequency
- Frequency tuning

### Numeric Keypad Active

Num Entry / Psh Enter ▶

Available functions:

- Numeric data entry

### Waypoint Identifier Keypad Active

Wpt Ident / Psh Enter ▶

Available functions:

- Waypoint identifier entry

### Direct To Window Active

Edit Wpt / Psh Activate ▶

Available functions:

- Direct-to waypoint editing
- Activate direct-to course

## Screen Captures

### FEATURE REQUIREMENTS

- SD card in the FAT32 format, with memory capacity between 8 GB and 32 GB

Save images to an SD card at any time using a screen capture. Images automatically save to the “print” folder in the SD card root directory.



1. Insert an SD card into the card slot.
2. Push and hold the control knob.
3. With knob depressed, push and release the **Home** key.

A camera icon momentarily shows in the annunciator bar indicating a successful screen capture.

To view saved images, remove the SD card and open the “print” folder on a computer.

# Color Conventions

**Red**

- Warning conditions

**Yellow**

- Cautionary conditions

**Green**

- Safe operating conditions
- Engaged modes
- Active COM frequency

**White**

- Scales and markings
- Current data and values

**Magenta**

- GPS data
- Active flight plan legs

**Cyan**

- Pilot-selectable references
- Standby frequencies

**Gray**

- Missing or expired data
- Product unavailable

**Blue**

- Water

# Compatible Equipment

## Line Replaceable Units

<b>OPTIONAL LRUs</b>
ADC
AHRS
Autopilot
Cross-side GTN
DME
Flight Stream 210/510
G3X Touch
G5
G500/G600
G500(H)/G600/G700 TXi
GAD 42 Adapter
GDL 69/69A SiriusXM Datalink
GDL 88/GTX 345 ADS-B Transceiver
GMA 35/350
GMX 200
GSR 56 Satellite Datalink
GTX Transponders
MX 20
Radar Altimeter
Stormscope
TAS/TCAS
<b>OPTIONAL INTERFACES</b>
TCAS II
Airborne Weather Radar (GTN 750Xi Series only)

The system consists of multiple LRUs, which are installed behind the instrument panel or in a separate avionics bay. Their modular design aids system maintenance and unit replacement.

Optional LRUs may include compatible equipment from either Garmin or a third party manufacturer. These vary by unit and installation type (VFR or IFR).

Some LRUs provide features that require registration and/or enablement prior to activation.

Compatible LRUs are not limited to the devices shown here.

# 2 Get Started

POWER UP .....	2-2
DATABASES.....	2-5
CONNECTIVITY.....	2-19
COM.....	2-23
NAV .....	2-39
AUDIO PANEL.....	2-41
XPDR .....	2-50
ADS-B ALTITUDE REPORTING.....	2-56
PILOT SETTINGS.....	2-59
STATUS INDICATIONS.....	2-74
LOGS.....	2-83

# Power Up

The unit receives power directly from the aircraft's electrical system. Upon power-up, the bezel key backlight momentarily illuminates. System failure annunciations typically disappear within the first 30 seconds after power-up.



The start-up screen presents the unit software versions, the name and status of all installed databases, and the Database Updates page access key.

Tapping **Continue** advances to the Instrument Test page.

## WI-FI SETUP ACCESS

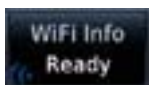

If a Flight Stream 510 wireless datacard is present, the **WiFi Info** key appears in the controls bar. Tapping this key opens a setup page. Refer to Wi-Fi Setup for instructions.

## Instrument Panel Self-Test

To ensure safe operation, continuous built-in test features exercise the unit's processor, memory, external inputs, and outputs. The Instrument Panel Self-Test page displays the results of all external equipment checks performed by the unit.



Review this list to ensure that all CDI/HSI outputs and other displayed data are correct for the connected equipment.

Tapping **Continue** advances to the Home page.

If an instrument remains flagged after one minute, check the status of the associated LRU, then contact a Garmin dealer for support.

## Preset Fuel Quantities



### CAUTION

*Ensure that estimated fuel quantity values are accurate before flight.*

#### FEATURE LIMITATIONS

*For the operating limitations of a specific aircraft, consult the POH.*

GTN stores preset fuel amounts for estimated full and tab amounts. These settings may not be editable if the unit is interfaced with a digital fuel computer.



#### Fuel on Board

Specify the current fuel quantity.  
Tapping this key opens a keypad.  
Preset keys for "full" and "tabs" aid in fuel data entry.

Initial value automatically reduces based on current fuel flow.



#### Fuel Flow

Set fuel flow amount.  
Tapping this key opens a keypad.

### FUEL CAPACITY ENTRY KEYS



#### Set Full/Tabs

Opens the Fuel Capacity Setup menu. Select the appropriate data entry key and enter the estimated fuel amounts.

**Fuel Full Capacity:** Specify the tank full amount.

**Fuel Tab Capacity:** Specify the tank tab amount.

These values vary according to aircraft type.



#### Full

Sets the fuel remaining value to the specified full amount.



#### Tabs

Sets the fuel remaining value to the specified tab amount.

### FUEL CAPACITY UNITS



Fuel capacity units are set in the System Units app.

#### From the Home page:

Tap **System** > **Units** > **Fuel**, and select the preferred units.

# Databases



## NOTE

*The navigator supports SD cards in the FAT32 format only, with capacities ranging between 8 GB and 32 GB.*

Databases are stored in the unit's internal memory. To view update cycles, or to purchase individual databases or database packages, go to [flyGarmin.com](https://flyGarmin.com).

There are two methods for loading and updating databases. Do not attempt either of these while in flight (on ground only).

- **Load databases via SD card.** Once loading completes, you may power off the unit and remove the card.
- **Transfer databases from a Flight Stream 510 wireless datacard.** This method requires the Garmin Pilot app on a portable electronic device.

## SUPPORTED DATABASES

<b>Basemap</b>	Bodies of water, geopolitical boundary, and road information
<b>ChartView</b> <sup>[1]</sup>	Jeppesen terminal procedures
<b>FliteCharts</b>	AeroNav terminal procedures
<b>Navigation</b>	Airport, NAVAID, waypoint, and airspace information (Garmin or Jeppesen)
<b>Obstacles</b>	Obstacle and wire data
<b>SafeTaxi</b>	Airport surface diagrams
<b>Terrain</b>	Terrain elevation data

[1] Optional third party database.

## Aviation Database Errors

Visit [flyGarmin.com](https://flyGarmin.com) to report any discrepancies in database information. These may include incorrect procedures, inaccurate depictions of terrain, obstacles and fixes, or errors with any other screen element used for navigation or communication purposes.

For information regarding third party navigation databases, go to [jeppesen.com](https://jeppesen.com).

# Database Effective Cycles

Most databases expire at regular intervals. Exceptions include Basemap and Terrain, which neither expire nor update on a regular schedule.



The start-up page lists all currently installed databases. Review this list for current database types, cycle numbers, and expiration dates.



Yellow text denotes when a database is:

- Not available
- Installed before its effective date
- Missing date information
- Past its expiration date

## DATABASE EFFECTIVE STATUS

### Databases with no effective date

- Effective upon release
- Includes Basemap and Terrain

### Databases with specified effective dates

- Effective during a specific period
- Unit determines database status using the current date and time from GPS
- Automatic activation occurs on the effective date

## Overwriting SD card database files

When loading database files to an SD card, be aware that any existing database files that are of the same type will be overwritten. This includes databases off a different coverage area or data cycle than that residing on the SD card.

# Active and Standby Databases

The navigator uses two types of databases:

## Active Databases

The databases in use by the system.

## Standby Databases

Databases that have not reached the effective date. These remain on the SD card until they become effective.

## Database Info

### WHERE TO FIND IT

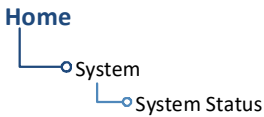

During normal operation, you can view information about all active and standby databases from the System Status page.

### ACTIVE DATABASE LIST

Navigation Database			
Region:	WW-ADB2	Cycle:	1809
Effective:	16-AUG-18	Expires:	13-SEP-18
Basemap Database			
Version:	18M1	Created:	13-MAR-18
Obstacle/HOT Line Database			



Selecting **Active** displays information about the databases currently in use. You can also access copyright information from here.

Tapping **View Copyrights** displays copyright information for all installed databases.

## STANDBY DATABASE LIST



Selecting **Standby** displays information about databases that are not yet effective.

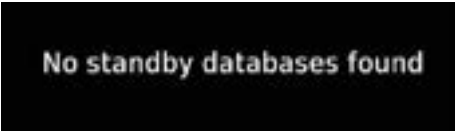

GTN notifies when no standby databases are available.

## DATABASE NOT FOUND



Notifications for databases not present or available also display in the form of system messages.



Review the Active Database Info list to determine the status of the indicated database.

Database Not Present

# Manual Updates

## FEATURE LIMITATIONS

The Database Updates page is available only when:

- The aircraft is on ground
- The start-up page is active (i.e., during power up)

## Database Updates Page



This page presents a list of all available databases.

To open, tap the **Databases** key on the start-up page.

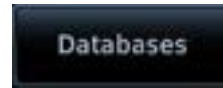

## DATABASE SOURCE INDICATION

Connect Icon

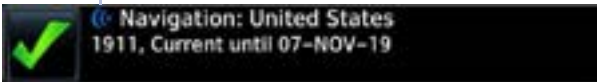

A Connect icon indicates when a database is from Garmin Pilot via wireless transfer. No indication means the database is either from an SD card or the unit's internal standby queue.

## SELECT ALL DATABASES

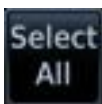

Select individual databases for transfer, or choose **Select All** if all listed databases require updating.



By default, this page displays only the databases recommended for update.

A message notifies when no such databases are available.



After all selections are made, initiate the update process by tapping **Start**.

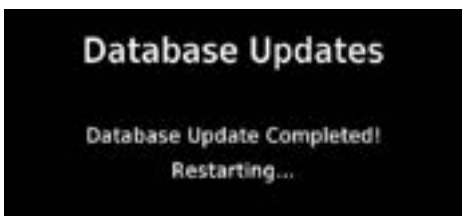

The unit automatically restarts once all updates are complete.

## SHOW ALL DATABASES



Tapping **Show All** displays a complete list of all databases.



This list may include databases that are:

- Not yet effective
- Older than the currently active database(s)
- Unable to update due to an error

## ERROR INFORMATION



To determine the cause of a database error, tap **Error Info**.



An information window provides details regarding the state of the database.

## SELECT REGION



This key appears when two databases are of the same type and cycle, but pertain to different regions.



### To specify a database region:

Tap **Select Region**, then select the appropriate menu option.



# Automatic Updates

## Automatic updates occur when:

- A newer database is detected on the SD card or in the internal standby queue
- A newer database is within its effective dates
- The aircraft is on ground

When a newer database is available, follow the on-screen prompts to complete the update process.

## INSTALL OR UPDATE A DATABASE USING AN SD CARD



1. Download a database onto an SD card.
2. Insert the SD card with the most recent database(s) into the card slot.
3. Power on the unit.



Selecting **Update** opens the Database Updates page, where a list of the newest databases is available for review.



Select the databases for transfer, then tap **Start**.



All newer databases (effective and expired) transfer from the SD card to the internal standby queue.

A progress bar displays the name of each database as it uploads to the unit.

Terrain databases may require up to 5 minutes for transfer. Total transfer time depends on the SD card type.

The unit automatically restarts once the update is complete. Updates are indicated in the list of currently installed databases.

# Database Concierge

## FEATURE REQUIREMENTS

- *Flight Stream 510 wireless datacard*
- *Garmin Pilot app on a mobile device*
- *The aircraft is on ground*



Database Concierge allows wireless transfer of databases from a mobile device while the aircraft is on ground.

A pilot selects and downloads databases inside the Garmin Pilot app. Transfers occur once Flight Stream 510 establishes a wireless connection inside the aircraft.

## Database Concierge Transfer Function

- Provides automatic updates for databases with effective dates
- Preloads databases that are not yet effective by placing them in the internal standby queue
- Displays database type, cycle, effective date, and transfer progress
- Allows manual operation via **Start** key
- Requires pilot confirmation

## TRANSFER A DATABASE USING DATABASE CONCIERGE



1. Purchase database(s) from [flyGarmin.com](http://flyGarmin.com).
2. Open Garmin Pilot and follow the download instructions.
3. Install Flight Stream 510 and then power on unit.
4. Connect to Wi-Fi.
5. Follow the on-screen prompts.

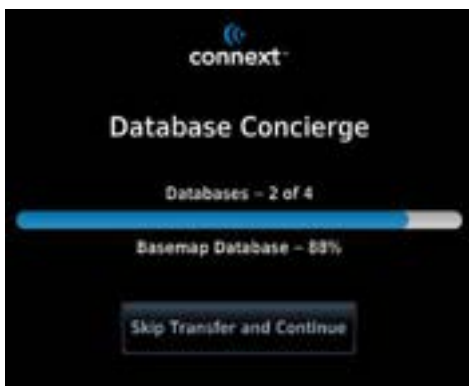

Database Concierge transfers databases from the app to Flight Stream 510. A progress bar shows when this process is complete.

GTN either updates or preloads databases based on their effective date. A second progress bar indicates upload status.

The unit automatically restarts upon database activation.

### SKIP TRANSFER

Tapping **Skip Transfer and Continue** cancels any unfinished wireless transfers and initiates the update process.

The unit activates any databases that completed transfer before the interruption. Previously selected databases on an SD card or in the internal standby update as well.

The message "Transfers interrupted" displays if no databases are available.

# Database SYNC



Database SYNC minimizes database maintenance by synchronizing active and standby databases across all configured LRUs. Once a standby database becomes effective, each LRU automatically generates an update prompt.

## FEATURE LIMITATIONS

- Not applicable to Terrain database

## WHERE TO FIND IT

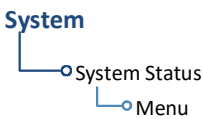

This function resides in the System Status menu.

Home > **System** > **System Status** > **Menu** > **Database SYNC**



A pop-up informs you that enabling Database SYNC may overwrite any databases currently in standby.

Toggling the function off disables the Chart Streaming function (if enabled).

## Database SYNC Transfer Function

- Enables automatic database synchronization across all capable Garmin avionics
- Includes active and standby databases
- Prompts unit restart if a new database is effective and the aircraft is ground

# Chart Streaming



Chart Streaming allows streaming of individual charts on an as-needed basis until database sync is complete.

Toggling this function off has no affect on Database SYNC.

## FEATURE LIMITATIONS

- Available only when Database Sync is active and a current chart database is available

## WHERE TO FIND IT

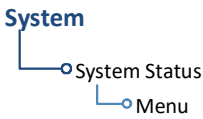

This function resides in the System Status menu.

Home > **System** > **System Status** > **Menu** > **Database SYNC** > **Chart Streaming**

## Chart Streaming Function

- Enables automatic streaming of individual charts from the newest chart database
- LRUs with chart streaming enabled display the most current chart information
- Current charts display on the Charts page; chart overlays are available for display on Map
- Chart database effective date displays on Charts page when chart expires
- Available for both ChartView and FliteCharts

A typical chart database may take up to one hour to synchronize across multiple LRUs.

# Connectivity



Connex works via the Bluetooth data link to provide up-to-date, wireless information throughout the cockpit.

## FEATURE LIMITATIONS

- Unit allows pairing of up to 13 Bluetooth enabled devices, with two simultaneous device connections
- Auto reconnect function is not available for Android devices

## Connex Setup

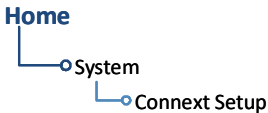

The Connex interface allows communication with Garmin Pilot from a portable electronic device.

### Connex Features

The following features are available on your portable electronic device.

- GPS position and velocity information
- Uncorrected barometric pressure altitude used by transponder and ADS-B
- ADS-B In traffic data
- FIS-B weather and flight information
- AHRS data from built-in sensor [1] [2] [3]

[1] Attitude data does not output to other installed avionics.

[2] The internal AHRS sensor is only for use with a portable electronic device. All internal AHRS functions are automatic and do not require pilot action.

[3] Flight Stream 210

# Bluetooth Setup

## Bluetooth Wireless Features

- FIS-B weather
- ADS-B traffic
- GPS/WAAS position, velocity, and time
- Pressure altitude
- AHRS
- Magnetic heading
- Flight plan transfer
- Flight data logs
- GXR 56 SMS messaging
- SXM weather

The unit supports wireless pairing with up to 13 portable electronic devices via the Garmin Pilot app.

Bluetooth device management options reside on the Paired Devices page. Opening this page automatically initiates device pairing.



Device information and pairing mode status display on the Connex Setup page.

Controls for enabling Flight Stream features are reside here. These include:

- Flight Plan Import
- Databases
- Phone/SMS

## BLUETOOTH NAME



This key allows you to enter the name of the Bluetooth enabled device. Use the keypad or control knobs to enter the device name.

## Managing Paired Devices

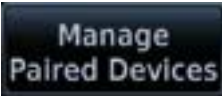

To view a list of all paired devices and their connection status, tap **Manage Paired Devices**.



To enable automatic connection between the unit and a paired device at power up, tap **Auto Reconnect**.

### AUTO RECONNECT

Enables automatic connection between the unit and the paired device when the two are within range.

### REMOVE

Removing a device from the list means it is no longer paired with the unit. This action requires pilot confirmation.

Be sure to remove pairing on both devices before attempting to pair them again.

### CONNECTION STATUS



The device is configured and communicating properly.



The device is not available and is not configured or it is not communicating properly.

## Importing a Flight Plan



This feature allows automatic import of flight plans via Bluetooth wireless technology.

It may be necessary to turn this function off if a portable device application makes repeated erroneous attempts to send flight plans to the unit.

Once transfer is complete, an advisory message informs that a new flight plan is available for preview.

To view the flight plan, acknowledge the advisory and tap **Preview**.

# Wi-Fi Setup



- Tapping **WiFi Info** opens an information page. This page is accessible from the Database Update and start-up pages. When setting up Wi-Fi, use a password that contains letters in mixed case and numbers.



Information includes:

- Database Concierge connection status
- Connected device name
- Database update availability and instructions
- Wi-Fi SSID and password

## WI-FI INFO KEY STATUS ANNUNCIATIONS

Wi-Fi connection status annunciates on the key label when the information page is not active.



Flight Stream 510 requires power up.



Wi-Fi is active, but the unit is waiting to connect with a device.



Connection complete. Flight Stream 510 requires Garmin Pilot to be opened in order for database transfer to commence.

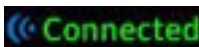

Garmin Pilot opened and streaming to unit.

## CONNECT TO WI-FI

Follow the onscreen prompts when connecting to the Wi-Fi network.

1. Install Flight Stream 510 and then power on unit. Observe Wi-Fi status changes from "Offline" to "Ready."
2. Tap **WiFi Info**.
3. Enter the required SSID and password using the provided keypads.
4. Enable Wi-Fi setting on the portable device. Wi-Fi status changes to "Open App" once pairing is complete.

# COM

AVAILABLE WITH:  
GTN 635Xi/650Xi/750Xi

## COM Standby Control Panel



VHF COM transceiver controls are accessible via the selectable standby (STBY) frequency window.



1	Frequency Entry Field	4	Transfer (Flip-Flop) Key
2	Find Key	5	Data Entry Keys
3	Monitor Key		

### From the COM Standby control panel you can:

- Specify a standby frequency
- Swap active and standby frequency values
- Enable monitor mode
- Access radio volume controls

## COM Volume Controls

Percent of  
Max Volume

Relative Volume  
Indicator



Adjust radio volume with the small knob according to your preference.

The unit retains volume settings over power cycles.

## Open Squelch



Push the volume/squelch knob to override the automatic squelch function. Push it again to return the squelch to automatic operation.

“SQ” annunciates in the COM active frequency window to show when the squelch is overridden (i.e., when the squelch is open).

The automatic squelch function rejects many localized noise sources. Overriding this function may be helpful when listening to a distant station or setting the volume level.



### Volume/Squelch Knob Adjustments

Knob focus is determined by radio selection. Selecting the COM control sets the focus to the COM radio. Selecting the NAV control sets it to the NAV radio.

When COM radio is active:

- Pushing the knob disables automatic squelch control
- Turning the knob adjusts the COM volume percentage

If NAV radio is active:

- Pushing this knob enables or disables the ident tone.
- Turning the knob adjusts the NAV volume percentage.

# COM Radio Setup

**System**

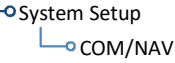

COM radio customization options are accessible via the System Setup app.



<b>1</b>	COM Channel Spacing Key	<b>3</b>	COM Sidetone Controls
<b>2</b>	Reverse Frequency Lookup Key		

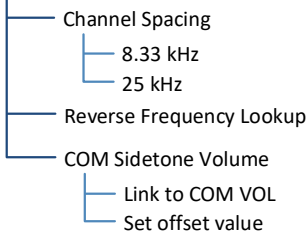

From here you can:

- Set transceiver channel spacing
- Enable reverse frequency look-up functionality
- Adjust sidetone volume offset

## COM Channel Spacing Option

The unit supports channel tuning for both 8.33 kHz and 25 kHz channels within radio-frequency range.



Tapping this key toggles the transceiver channel spacing between 8.33 kHz and 25.0 kHz.

### 8.33 kHz



8.33 kHz step configuration is available for European operations.

### 25.0 kHz\*



COM radio operates in the aviation voice band, between 118.000 and 136.975 MHz, in 25.0 kHz steps.

\*Channel spacing is set to 25.0 kHz by default.

If flying in a region where 8.33 kHz channel spacing is available, set the COM radio to 8.33 kHz to prevent the loss of any stored or recently used frequencies.

## Reverse Frequency Look-up

### FEATURE REQUIREMENTS

- Valid position data
- Active navigation database

### FEATURE LIMITATIONS

- Available only for the nearest stations in the database



Display the facility identifier and frequency type for active and standby frequencies.

The unit verifies the displayed frequency against the database at least once per minute.

Facility Identifier

KSLE ATIS+

Frequency Type

“+” denotes more than one type associated with the frequency.

### When frequency look-up is active, COM displays:

- Nearest facility identifier (if available)
- Multiple facility indication (if more than one)
- Frequency type
- Approach or Departure indications (if applicable)

When flying between airports that use the same frequency, it may take up to 2 minutes for look-up information to change after crossing the half way point.

# Sidetone Volume Offset

### FEATURE LIMITATIONS

- Availability dependent upon configuration
- Offset range: +/-25% of total COM audio volume range

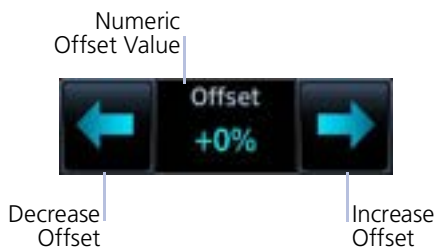

If the unit is wired for audio output, set the sidetone volume offset to the preferred level. By default, the offset value is set to zero percent.

The unit retains manual offset settings over power cycles.

COM sidetone is audio spoken into the microphone that is played back in real time over the headset. The offset setting determines sidetone volume for the COM during radio transmission. Adjustments determine the amount that the sidetone volume level is offset from the COM receiver volume or the configured sidetone volume.

## LINK TO COM VOLUME



Enabling this function allows you to adjust the amount that the sidetone volume level is offset from the COM receiver volume. These adjustments are dynamic in that they vary with the COM receiver volume level.

To adjust the offset from the COM receiver volume:

1. Enable **Link to COM VOL**.
2. Tap **Offset** and adjust as necessary.

To adjust the offset from the configured sidetone volume, disable **Link to COM VOL** and then adjust the offset as necessary. These adjustments are fixed as they are relative to the configured sidetone volume.

# Tuning & Monitoring

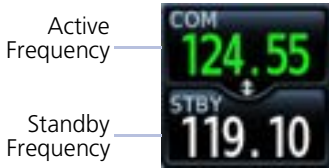

Communication frequencies are split between two selectable windows:

The upper window presents the active COM radio frequency. This is the frequency currently in use for transmit and receive operations.

The lower window presents the standby radio frequency. This frequency may be set and activated at any time.

## COM STATUS INDICATIONS

Status annunciations denote active functions, modes, and frequency types.

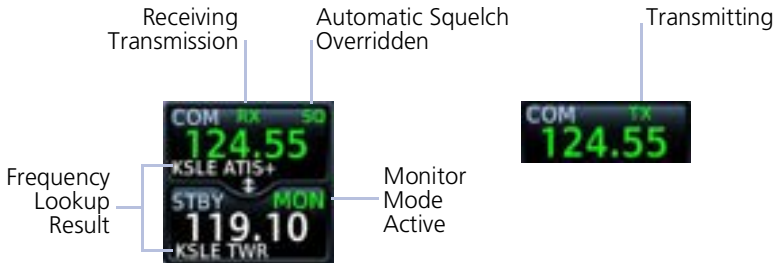

**TX**

Transmitting

**RX**

Receiving transmission

**MON**

Monitor mode active

**SQ**

Automatic squelch is overridden (i.e., squelch is open)

**KSLE TWR**

Reverse frequency information (sample text)

## Direct Tuning



You may enter a standby frequency using the data entry keys on the COM Standby control panel or by turning the control knob.

Tapping **STBY** opens the control panel. From here you may specify a frequency or select one using the provided search options.



119.10

The current standby frequency value displays in the direct tuning field.

## DATA ENTRY KEYS



Enter a new standby frequency using the provided data entry keys or by turning and pushing the control knob.

To cancel the entry and exit the control panel, tap **Back**.



Entering the new frequency value places it in standby.

## FREQUENCY AUTOFILL



118.00

Matching  
Frequency

Numeric characters autofill the first valid frequency value based on each selected digit.

Autofill characters are muted and display from the cursor position to the right of the field.



118.00

Invalid Selection

Selecting a digit that is not valid for the cursor location results in no entry.



Attempting to enter a frequency value after selecting an invalid digit generates a pop-up message.

Confirm the request by selecting **OK**.

## Simplified Frequency Entry

The direct tuning field allows you the option of entering frequencies without typing the leading and/or trailing digits. For example: To enter frequency 121.50, you need only tap **2**, **1**, and **5**. The field autofills the leading "1" and trailing "0."

## KNOB TUNING

The dual concentric control knob allows you to enter a standby frequency without opening the control panel. Pressing the knob toggles the selected standby frequency between COM and NAV radios.



The selected STBY window turns cyan when the knob is used to change the STBY frequency.



If no action occurs, the selected STBY window reverts to cyan text after 3 seconds. This indicates it can be controlled by the knob.



When the STBY COM frequency is no longer selected, it reverts to white text.

## Transfer Frequency to Active (Flip-Flop)

Before



After



The transfer (or *flip-flop*) function allows you to swap the active and standby frequency values.

This function is accessible multiple ways.

### ACTIVE FREQUENCY WINDOW



Tapping this window swaps the active frequency value with the standby frequency displayed in the lower window.

Tap once to swap the displayed frequency values. Tap again to swap them back.



A transfer icon indicates that flip-flop functionality is available.

### XFER KEY



Tapping this key on the COM Standby control panel performs the same function as tapping the COM active frequency window.

### CONTROL KNOB



Pushing and holding the control knob for 0.5 seconds automatically flip-flops the active and standby frequency values.

- “Hold for flip-flop” control label appears in the annunciator bar
- Standby and active COM frequency values swap



## Frequency Autofill & Transfer

If you initiate a transfer before completing frequency entry, the direct tuning field autofills the remaining characters, enters the frequency into the standby field, and then swaps it with the active frequency.

## Monitor Mode



Enabling monitor mode allows you to listen to the standby frequency while the unit continues monitoring the active COM channel.

When the COM active frequency receives a signal, the unit automatically switches back to the active frequency. Once activity on the COM active channel ceases, the unit returns to listening to the standby frequency.

Tower Transmission  
(Active Frequency)

ATIS Broadcast  
(Standby Frequency)



Monitor mode is useful when you want to listen to a recorded broadcast (e.g., ATIS) on the standby channel, but still receive control tower transmissions on the active channel.

# Frequency Selection

The unit provides multiple options for finding and selecting a standby frequency from the available database frequencies.

## Search Tabs



The **Find** key provides access to multiple search tabs. Each tab displays a list of selectable identifiers based on specific criteria.

### Nearest Airports

- Lists up to 25 airports within a 200 nm radius

### Nearest FSS & ARTCC

- List the distance, bearing, and frequency associated with the specified facility name

### Recent

- Lists up to 20 of the most recently tuned frequencies

### Flight Plan

- Lists all frequencies contained in the active flight plan

### User

- Lists up to 15 user-defined frequencies

## TAB ENTRIES



Each entry includes general information about the associated waypoint.

## MULTIPLE FREQUENCIES



Tap **Multiple FREQ** and select a frequency from associated pop-up.

This key appears when more than one frequency is available at the indicated identifier.

Applicable to functions displaying information only (Nearest Airports, FSS, and ARTCC).

## Remote Frequency Selection

### FEATURE LIMITATIONS

- *Availability dependent upon configuration*

On units configured for remote frequency recall, user frequencies are selectable via a remote switch.

- Pressing the switch once loads the next user frequency into the STBY window
- Pressing the switch repeatedly scrolls through the list of presets
- Some installations may have two dedicated recall switches: one to scroll up, one to scroll down
- Selections do not activate until transferred to active

## Emergency Frequency

Pressing and holding the volume knob provides a quick method for remotely tuning the emergency frequency (121.50 MHz). This function also sets 121.50 MHz as the active frequency. Remote COM Lock is not activated if using this method. This feature is available any time the unit is on, regardless of GPS or display status.

### Remote COM Lock

If configured, pressing and holding the remote COM transfer key for two seconds locks the COM at 121.50 MHz, preventing further changes in frequency. A message informs of the change in status. To unlock, press and hold the remote key again.

If the radio loses communication with the system, the unit automatically tunes to 121.50 MHz for transmit and receive operations, regardless of the displayed frequency.

# Create User Frequencies

## FEATURE LIMITATIONS

- Names may be up to seven characters in length
- Maximum number of 15 user frequencies

### Edit Frequency

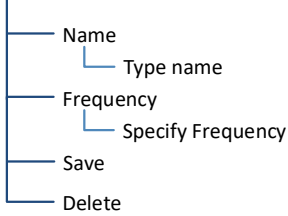

Create or edit user frequencies from the Edit Frequency pop-up menu.

<b>Name</b>	Assign the frequency a unique identifier.
<b>Frequency</b>	Specify a frequency value.
<b>Save</b>	Add the frequency to the user frequency list.
<b>Delete</b>	Remove the selected user frequency from the list. Appears only for existing entries.

## ADD A USER FREQUENCY

From the COM Standby page:

1. Tap **Find** > Select the **User** tab.
2. Tap **Add User Frequency**.
3. Specify the frequency name and value.
4. Tap **Save**.



A pop-up message informs when the user frequency list is full.

## EDIT USER FREQUENCY

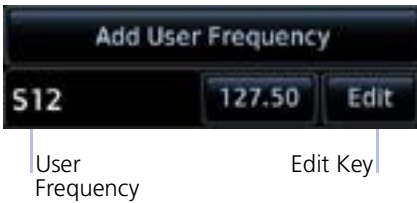

Tapping the **Edit** key for an existing entry opens the same pop-up. From here you may modify the user frequency name and value.

Tapping **Save** stores all changes.

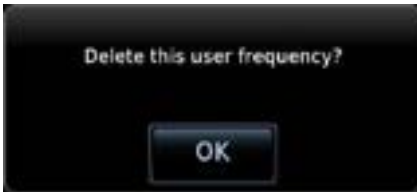

Tapping **Delete** removes the selected user frequency from the list. A pop-up message requests confirmation.

## COM Alert



If the radio fails:

- Red “X” displays over the COM key
- Advisory message alerts
- COM control page is not available

COM radio fail annunciations are designed to be immediately recognizable. If a failure occurs while the control page is active, the display automatically returns to the previous page.

For information regarding pilot response to a COM radio failure, consult the AFMS.

## Stuck Microphone

The COM transmitter automatically times out after 30 seconds of continuous broadcasting. This may occur when:

- Push-to-talk key on the microphone is stuck or accidentally left in the keyed position
- Push-to-talk function continues to transmit after releasing the key

The advisory message “COM push-to-talk is stuck” alerts for as long as the condition exists.

# NAV

**AVAILABLE WITH:**  
GTN 650Xi/750Xi

## Frequency Tuning & Selection

Navigation frequency tuning, transfer, and selection functions are identical to those used for communication frequencies.

### NAV Tuning

Frequency Identifier  
from Morse Code



Frequency Identifier  
Based on GPS  
Position

NAV frequencies are selected with the tuning cursor in the standby NAV frequency field, and using the small and large right knobs to dial in the frequency. The keypad may also be used for frequency entry after touching the Standby window.

GTN automatically decodes Morse code and displays the Ident for the active frequency above it.

The RFL (reverse frequency lookup) Identifier is displayed below the frequency and is only dependent on GPS position and database information.

### GTN 650Xi SERIES

Due to spatial considerations, only one frequency control may display at a time. COM is the default frequency control option.

### STANDBY NAV FREQUENCY ENTRY

Pushing the bottom knob once activates the NAV standby window. Rotate the inner and outer knob or tap **STBY** to enter in frequency manually. Upon selection, the NAV standby frequency window remains active approximately 30 seconds.



Pushing the bottom knob once activates the NAV standby window. Rotate the inner and outer knob or tap **STBY** to enter in frequency manually. Upon selection, the NAV standby frequency window remains active approximately 30 seconds.

If manually entering the standby frequency, tap **XFER** to assign it as the active frequency. You can also tap the NAV window to flip/flop the frequencies.

Frequency lookup results are based on GPS position and database information.

#### Navigation frequencies include:

- Glideslope
- Localizer
- VOR

### IDENT AND AUDIO AND VOLUME

When the NAV window is active, press the volume knob to enable NAV ident. When enabled, the ID annunciation appears in the active NAV window and Morse code tones can be heard. Adjust the NAV audio volume using the volume knob.

### NAV FREQUENCY FINDING



The **Find** key provides access to multiple search tabs. Each tab displays a list of selectable identifiers based on specific criteria.

# Audio Panel

AVAILABLE WITH:  
GTN 725Xi/750Xi

## Audio Panel Controls

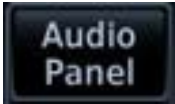

Audio panel controls are accessible via the **Audio Panel** key. This key is unavailable if not configured for audio or intercom LRUs, such as the GMA 35.



### PLAYBACK CONTROLS

The voice recorder feature records all audio heard on any MIC selected COM radio selected for transmission. Playback is heard by anyone listening on the selected radios. The clearance recorder can record up to 2.5 minutes of COM audio.



Tap **Playback Controls** to:

- Set volume level of recordings
- Play, pause, and cycle through recordings

### CABIN SPEAKER CONTROL AND VOLUME

When cabin speakers are active, tap **Speaker Volume** to set the volume level.

### HIGH SENSE

Prior to an ILS approach, tap **High Sense** for high marker sensitivity.

## Mic Setup

MIC selection can be set in the MIC window or on the Audio Panel page.

Tap **MIC** to toggle between MIC 1 and MIC 2. Under MIC Selection, select which COM you want as your MIC selection. The selected MIC is automatically monitored as indicated by the green numbers in the MON field.



## PASSENGER ADDRESS

Tap **Passenger Address** to toggle the passenger address system on and off.

## SPLIT MODE

Active:

- Pilot uses one radio for MIC audio while the copilot uses a different radio
- Pilot and copilot can transmit simultaneously over separate radios
- Pilot can still listen to individually selected radios
- Pilot and co-pilot may talk and listen independently to the radios or PA
- Crew Intercom key is available allowing pilot and co-pilot to talk to each other

Inactive:

- Crew Intercom key is removed
- Selections are limited to Monitored Radios and MIC Selection

## 3D Audio

When enabled, 3D audio allows you to focus on and understand one source at a time. Depending on the selected COM channel, audio can be heard from your left, in front of you, or from your right.







To hear 3D audio, set stereo/mono headphones to the stereo position.

## MARKER Audio

The GMA 35 marker beacon receiver uses an audio indicator to alert you when the aircraft passes over a marker beacon transmitter. When a green bar displays on the MRKR Audio key, the audio from the receiver can be heard on the headsets. Tap **MRKR Volume** to set the volume level of the alert.

The GMA 35 marker beacon receiver and indicators are part of the ILS system. The marker beacon lamps operate independently of any audio selection and cannot be turned off. The GMA 35 can drive external marker lamps if required and also provides an autopilot middle marker sense output.

Marker beacon annunciations alternate between the standard and blinking symbol at the blink interval noted.

STANDARD SYMBOL	BLINKING SYMBOL	MARKER TYPE	BLINK INTERVAL
		Inner	250 ms
		Middle	333 ms
		Outer	750 ms

# Intercom

**AVAILABLE WITH:**  
GTN 725Xi/750Xi

## Intercom Modes



Intercom controls are accessible via the **Intercom** key. There are different modes of operation to control communication, music, and the telephone in the aircraft.

Tap the arrow between the intercom recipients. When the arrow is green, it indicates communication is active between the recipients.



You can allow the co-pilot to hear what passengers hear.

Tap **Menu > Group Co-Pilot** with **Passenger**.

- Split mode is unavailable
- Co-pilot intercom/audio controlled by passenger

**This is not recommended for multi-crew aircraft.**

### Intercom Setup

Setup controls allow you to access:

- Communication modes between pilot, co-pilot, and passenger
- Distribution and mute options for two music interfaces
- Distribution and volume of phone calls

Passengers cannot transmit over the active COM radio, even if equipped with a PTT key.

### VOLUME AND SQUELCH ADJUSTMENTS

Volume and Squelch may be set separately for the Pilot, Copilot, and Passenger intercoms.

To set volume and squelch levels, tap **Pilot VOL/SQ**, **Co-Pilot VOL/SQ**, or **Passenger VOL/SQ**.

Tap arrow to increase or decrease volume and squelch.

Tap **Auto Squelch** to allow the unit to set squelch level automatically.



### Music Setup

The GMA 35 provides two music interfaces. Select **Music 1** or **Music 2** to set:

- Who hears music
- When to mute music
- Music volume

At every power cycle, the “Mute music during radio” selection is active.

## Telephone Setup



### NOTE

*Garmin recommends when using the GSR 56 Iridium phone system that the audio only be activated when on a phone call*

The GMA 35 provides a 2-way telephone interface and depends on the state of the telephone distribution. Telephone communication is much like using the intercom, allowing both parties to talk at once.

Tap **Telephone** to set:

- The recipients of a telephone call
- The volume of the telephone call

Telephone audio distribution is retained across power cycles for the passengers. Pilot and co-pilot telephone distribution deactivates after a power cycle.

## Bluetooth Audio

The GMA 35c provides an audio connection to a portable device via Bluetooth wireless technology.

Tap **Bluetooth** to set:

- Who can hear the Bluetooth enabled device
- When to mute audio
- Volume level

# Telligence Voice Command

## FEATURE REQUIREMENTS

- *Compatible audio panel*

Garmin's Telligence Voice Command voice recognition feature allows the pilot and copilot to control the GTN Xi connected to a required GMA 35/350 using spoken commands. To activate Voice Recognition, push and hold the Push-to-Command (PTC) switch and speak a command. Release the PTC switch and the GTN Xi and/or the audio panel responds with a positive acknowledgment chime.

A negative acknowledgment tone plays if a command is not understood or the GMA and/or GTN Xi is unable to complete the request. Repeat the command by using the PTC switch, or by manually using the GTN Xi touchscreen. In the event of any abnormal voice recognition operation, the front panel controls and touchscreen may be used to override voice recognition and manually control the unit.

If Telligence Voice Command malfunctions and needs disabling, remove power from the GMA audio panel. This forces the audio panel into the fail-safe mode. The pilot can communicate using the COM 2 radio only.

## PASS/FAIL INDICATIONS

### AUDIBLE TONE DEFINITIONS

<b>AUDIBLE TONE DEFINITIONS</b>	
	<b>Pass</b>
Ascending (low to high)	Command recognized and executed. Example: "Show Map page" is spoken and moving map displays
	<b>Fail</b>
Descending (high to low)	Command unrecognizable or invalid. Example: "Show Map page" is spoken and the page does not change

## Voice Command Setup

To enable voice recognition, tap **System** > **Voice Commands** > **Voice Commands**.



### VOICE COMMAND HISTORY

Tap **Command History** to view a list of recently spoken commands.



For a list of available voice recognition commands, consult *Telligence Voice Command Guide*.

# XPDR

## XPDR Control Panel



Transponder controls are accessible via the **XPDR** key. This key is unavailable when the control panel is active.



<b>1</b>	Squawk Code Entry Field	<b>3</b>	XPDR Mode Selection Keys
<b>2</b>	Squawk Code Entry Keys	<b>4</b>	VFR Key

### The XPDR key becomes available when you:

- Enter a squawk code
- Open the XPDR menu
- View a message
- Select the **Mode** key
- Leave the control panel

# XPDR Setup

## XPDR Menu

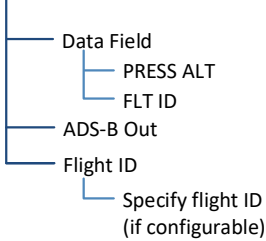

Tap **Menu** to access the transponder setup options. From here you can:

- Change the display of data
- Enable 1090 ES ADS-B Out functionality (if configured)
- Assign a unique flight ID

## Enabling Extended Squitter Transmissions

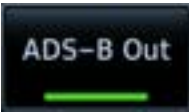

Tapping **ADS-B Out** allows the transmission of ADS-B Out messages and position information.

## Assigning a Flight ID

### FEATURE LIMITATIONS

- Availability dependent on configuration



If the flight ID is editable, tap **Flight ID** and assign a unique identifier.

Flight IDs are alphanumeric (upper-case only) and have an eight character limit. The active flight ID displays by default.

# XPDR Modes

Tapping **Mode** opens a menu of the available transponder modes. Options include Standby, On, and Altitude Reporting.

MODE OPTIONS	
<b>Standby</b>	<ul style="list-style-type: none"><li>• Transponder does not reply to interrogations or transmit ADS-B Out</li><li>• Bluetooth wireless functions remain operational</li><li>• Unit continues to receive ADS-B In information, but is not a TIS-B participant</li></ul>
<b>On</b>	<ul style="list-style-type: none"><li>• Transponder replies to interrogations. Replies do not include pressure altitude</li><li>• Reply (R) symbol on the display indicates the transponder is responding</li><li>• Transmitted ADS-B Out does not include pressure altitude</li></ul>
<b>Altitude Reporting</b>	<ul style="list-style-type: none"><li>• Transponder replies to identification and altitude interrogations</li><li>• Reply (R) symbol indicates the transponder is responding</li><li>• Transmitted ADS-B Out includes pressure altitude</li></ul>

During Altitude Reporting mode, all aircraft air/ground state transmissions are handled via the transponder and require no pilot action. Always use this mode while in the air and on the ground, unless otherwise requested by ATC.

# Squawk Code Keys

SPECIAL SQUAWK CODES	
1200	Default VFR code (USA)
7500	Hijacking
7600	Loss of communications
7700	Emergency

Eight squawk code entry keys (0 – 7) provide access to all ATCRBS codes. Tapping one of these keys begins the code selection sequence.

Use the **Backspace** key or outer control knob to move the cursor.



Digits that are not yet entered appear as underscores.

Activate the new code by tapping **Enter**. To cancel the code entry and exit the page, tap **Cancel**.



Active squawk codes remain in use until a new code is entered.

## VFR



Tapping this key once sets the squawk code to the preprogrammed VFR code.

This code is factory set to 1200, but may be changed during configuration.

## XPDR Key

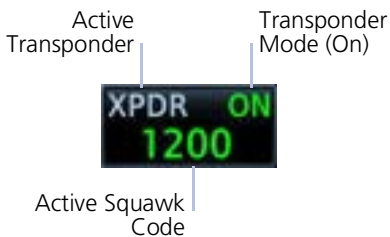

Tapping the **XPDR** key activates the IDENT function for 18 seconds. This signal distinguishes the transponder from others on the air traffic controller's screen.

Tapping this key when another page is active immediately opens the control panel.

## TRANSPONDER STATUS INDICATIONS

### IDENT



- Reply active
- IDENT function active
- No change to transponder code

### Standby Mode

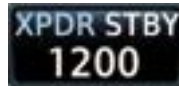

- Standby mode
- Current squawk code (inactive)

### IDENT with New Squawk Code



- Reply active
- Transponder code modified

### Altitude Reporting Mode



- Altitude reporting mode
- Reply active
- Identify function active
- VFR squawk code (active)



Reply active



IDENT function active



Transponder in operation



Altitude Reporting



Standby



Tap to initiate the IDENT function (code unmodified)



Tap to accept modified code and initiate IDENT function

## XPDR Alert



If the transponder fails:

- Red “X” displays over the IDENT key
- Advisory message alerts
- XPDR control page is not available

Transponder fail annunciations are designed to be immediately recognizable. If a failure occurs while the control page is active, the display automatically returns to the previous page.

For information regarding pilot response to a transponder failure, consult the AFMS.

# ADS-B Altitude Reporting

## FEATURE REQUIREMENTS

- GDL 88

## FEATURE LIMITATIONS

- Display and control functionality dependent on GDL 88 configuration

## ADS-B Control Panel



ADS-B Out controls are accessible via the **ADS-B** key. The location of this key varies by unit type.

### GDL 88 Features

- Remote-mount ADS-B transceiver
- Transmits ADS-B Out messages to ATC and other aircraft
- Communicates ADS-B In data to panel-mounted avionics for the display of traffic and weather

When interfaced to a GDL 88 transceiver, GTN allows control over some aspects of the ADS-B Out message and provides position information to the GDL 88.

Not all installations allow pilot control of ADS-B Out transmissions.

For more information, consult the *GDL 88 ADS-B Transceiver Pilot's Guide*.

## ADS-B Key

### FEATURE LIMITATIONS

- *Functionality dependent upon GDL 88 configuration*

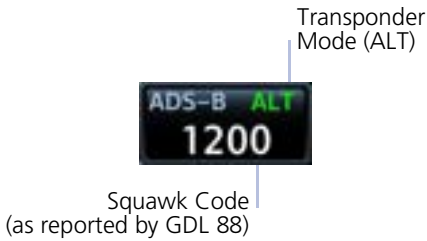

Depending on the configuration of your GDL 88, tapping the **ADS-B** key:

- Reports GDL 88 altitude reporting status

### OR

- Allows on/off control of the GDL 88's altitude reporting function

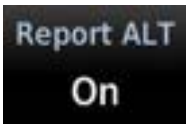

"ALT" indicates that the unit is in altitude reporting mode.

This indication corresponds to the function status annunciation on the control panel.

## Enabling Anonymous Mode

### FEATURE LIMITATIONS

- *Availability dependent on GDL 88 configuration*

During anonymous mode, the unit replaces identifying information in the ADS-B Out message with a temporary randomized number for privacy while providing position information. Instead of a flight ID, the unit transmits the call sign "VFR."



Tap **ADS-B > Anonymous**.

The key label changes from "Off" to "Armed."

Tapping **Anonymous** again toggles the mode off.

# Assigning a Flight ID

### FEATURE LIMITATIONS

- Availability dependent on GDL 88 configuration



If the flight ID is editable, tap **Flight ID** and assign a unique identifier. The key is not selectable (read-only) when the ID is received from the GDL 88.

Flight IDs are alphanumeric (upper-case only) and have an eight character limit. The active flight ID displays by default.

## GDL 88 Alert



If the GDL 88 fails:

- Red "X" displays over the IDENT key
- Advisory message alerts
- ADS-B reporting functions are not available

Failure annunciations are designed to be immediately recognizable. If a failure occurs while the control page is active, the display automatically returns to the previous page.

For information regarding pilot response to ADS-B failures, consult the AFMS.

# Pilot Settings



Unit customization options are accessible via the System menu. For details about COM/NAV radio settings and Connex Setup options, refer to the respective section.



## Setup

- Set CDI scale and capture type
- Specify runway criteria
- Set time format & local offset
- Select a keypad type
- Enable crossfill functionality
- Access NAV radio settings (GTN 650Xi/750Xi)
- Access COM radio settings (GTN 635Xi/650Xi/750Xi only)



## Units

- Set the display units



## Alerts

- Set airspace & arrival alerts



## Audio

- Adjust click volume



## Backlight

- Adjust display brightness



Other setup options allow you to monitor time in flight and create custom reminder messages. These settings reside in the system Utilities.



### Flight Timers

- Set departure & trip timers
- Set a generic timer for general timing needs



### Alerts

- Set custom reminder messages and when they display

## CDI Scale

### WHERE TO FIND IT

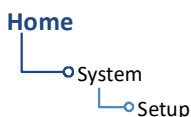

Set the scale for the course deviation indicator. Scale values represent full scale deflection for the CDI to either side.

Options: • 0.30 nm • 1.00 nm • 2.00 nm • Auto

Scale selections are reflected in the annunciator bar.

### Auto Setting Annunciation



### Manual Setting Annunciation



**CDI scale is set to “Auto” (default).** At the default setting, the scale sets to 2.0 nm during the en route phase of flight.

**Aircraft is within 31 nm of the destination airport (i.e., terminal area).**

The scale linearly ramps down to 1.0 nm over a distance of 1 nm.

**Aircraft is leaving the departure airport.** The scale is set to 1.0 nm once the aircraft is over 30 nm from the departure airport. It begins to gradually ramp up to 2 nm when the flight phase changes from terminal (TERM) to en route (ENR).

During GPS approach operations, the scale gradually transitions down to an angular scale.

**Aircraft is 2.0 nm before the final approach fix.** Scaling tightens from 1.0 nm to the angular full-scale deflection defined for the approach (typically 2.0°).

Selecting a lower value (0.3 nm or 1.0 nm) prevents the selection of higher scale settings during ANY phase of flight. Example: If you select 1.0 nm, the unit uses this setting for en route and terminal phases, and ramps down further during approach.

## Horizontal Alarm Limits

Horizontal alarm limits (HAL) are used to compare against GPS position integrity. These protection limits follow the CDI scale, unless the corresponding flight phase requires a lower HAL. For example, the selected scale setting is 1.0 nm, but full-scale deflection during approach still follows the approach scale setting (0.30 nm).

FLIGHT PHASE	CDI SCALE	HORIZONTAL ALARM LIMIT
Approach	0.30 nm or Auto	0.30 nm
Terminal	1.00 nm or Auto	1.00 nm
En Route	2.00 nm or Auto	2.00 nm
Oceanic	Auto	2.00 nm

# ILS CDI Capture

## FEATURE LIMITATIONS

Automatic switching is not available for aircraft equipped with a KAP 140/KFC 225 autopilot



Tapping this key sets the manner in which ILS CDI capture occurs: automatically or manually

This function may not be available in certain installations.

### Auto Switch

GTN automatically switches the external CDI from GPS to VLOC on ILS approach.

### Manual Selection

Allows you to manually switch the external CDI connection using the **CDI** key.

For more about ILS approaches, refer to the Procedures section.

# Keyboard Type

## WHERE TO FIND IT

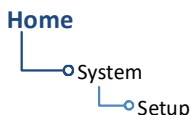

Select a preferred keyboard type for data entry operations. This option resides in the System Setup page.



Tapping this key opens a menu of available keyboard types. Options and layout vary according to display size.

KEYBOARD TYPE	GTN Xi SERIES	
	650	750
Alphabetical (ABC)	•	•
U.S. standard (QWERTY)	•	•
Slider	•	

# Airport Runway Criteria

## WHERE TO FIND IT

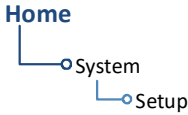

Specify runway criteria from the System Setup app. Selections determine which airports are suitable when using the nearest airport search feature.

During an approach, the terrain alerting algorithm uses airport runway settings to avoid nuisance alerts.

## RUNWAY SURFACE

### Runway Surface Options

- Any
- Hard Only
- Hard/Soft
- Water

Tap **Runway Surface** and then select the runway surface type.

Selecting “Any” allows all surface types to appear in the nearest airport list and be considered for use by Terrain.

## MINIMUM RUNWAY LENGTH

Specify a minimum runway length to:

- Exclude airports with shorter runways from the nearest airport list
- Inform the terrain function of which airports are available for use, so that terrain alerts do not generate when landing at one of these airports

Typing “0” allows runways of any length to appear in the nearest airport list and be considered for use by Terrain.

## INCLUDE USER AIRPORTS

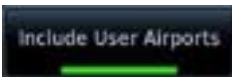

You can include user-defined airports in your nearest airport search. Deselecting this key excludes user airports from the search criteria.

# Clocks & Timers

## Timers



Monitor time in flight using three available timer types.

### WHERE TO FIND IT

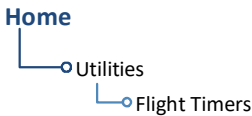

Timer settings are accessible via the Utilities menu page. Toggle between timer types using the provided display key.

#### Clock/Generic Timer

Stopwatch style counter.  
Count up or count down.  
Specify countdown time using the preset function.

**Controls:**

- Direction (Up, Down)
- Start • Stop • Timer Preset
- Reset Timer

#### Trip/Departure Timers

Measure elapsed airborne time since the last ground-to-air transition. Set timer to start at unit power up or once the aircraft is in air.

**Controls:**

- Criteria (Power On, In Air)
- Reset Timer

## Clock

### WHERE TO FIND IT

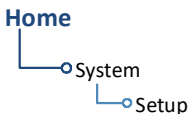

Specify the time format and local offset. Settings reside in System Setup.

Format options include Local 12 hour, Local 24 hour, and UTC.

If a 12 hour or 24 hour clock is selected:

Tap **Local Offset** > Specify the appropriate offset value from UTC.

# Alerts Settings



Receive alert messages when nearing your destination and/or entering a specific airspace type.

## FEATURE LIMITATIONS

- *Alert altitudes are dependent on aircraft and airspace altitudes and the pilot-specified altitude buffer value*

## Arrival Alerts

Arrival alerts generate a message when the aircraft is within a specified proximity of the destination. Distance units are based on the System Units setting.

### ENABLE AN ARRIVAL ALERT

Tap **Arrival** > **Proximity**, then enter a distance value.

## Airspace Alerts

Airspace alerts generate a message and filtering of the Nearest Airspace list. They rely on three-dimensional data (altitude, latitude, and longitude) to avoid nuisance alerts.



Control keys allow you to select which airspace boundaries generate an alert annunciation upon entry.

### Airspace Alert Options

- Class B/TMA
- Class C/TMA
- Class D
- Restricted
- MOA (Military)
- Other
- Alt Buffer
  - Specify buffer value

Airspace alerts for Prohibited airspace cannot be disabled.

Alert boundaries for controlled airspace are sectorized to provide complete information on any nearby airspace.

Alert settings do not alter the depiction of airspace, nor do they change Smart Airspace settings on the Map page.

With the exception of Altitude Buffer, airspace alert options are on/off only.

# Unit Selections



Customize the display unit settings. Tapping a parameter key opens a menu of the available unit types.

PARAMETER	SETTINGS
<b>Altitude/Vertical Speed</b>	<ul style="list-style-type: none"> <li>• Feet (ft/fpm)</li> <li>• Meters (m/mps)</li> </ul>
<b>Distance/Speed</b>	<ul style="list-style-type: none"> <li>• Nautical Miles (nm/kt)</li> <li>• Statute Miles (sm/mph)</li> <li>• Kilometers (km/kph)</li> </ul>
<b>Fuel</b>	<ul style="list-style-type: none"> <li>• Gallons (gal)</li> <li>• Imperial Gallons (lg)</li> <li>• Kilograms (kg)</li> <li>• Liters (lt)</li> <li>• Pounds (lb)</li> </ul>
<b>Magnetic Variation</b>	<ul style="list-style-type: none"> <li>• Specify number of degrees for east or west (°E, °W)</li> <li>• Available only when "User (°U)" is the active NAV angle</li> </ul>
<b>NAV Angle</b>	<ul style="list-style-type: none"> <li>• Magnetic (°)</li> <li>• True (°T)</li> <li>• User (°U)</li> <li>• External†</li> </ul>
<b>Position Format</b>	<ul style="list-style-type: none"> <li>• LAT/LON DD.D°</li> <li>• LAT/LON DD°MM.M'</li> <li>• LAT/LON DD°MM'SS"</li> <li>• MGRS</li> <li>• UTM</li> <li>• Swiss Grid</li> <li>• Irish Grid</li> <li>• British National Grid</li> </ul>
<b>Pressure</b>	<ul style="list-style-type: none"> <li>• Inches in Mercury (in)</li> <li>• Hectopascals (hPa)</li> <li>• Millibars (mb)</li> </ul>
<b>Temperature</b>	<ul style="list-style-type: none"> <li>• Celsius (°C)</li> <li>• Fahrenheit (°F)</li> </ul>

† Availability dependent upon configuration.

## SPECIFY UNIT TYPE

1. Review the current unit selections.
2. Tap the applicable parameter key.
3. Select a unit type.

## User Selected NAV Angle



### NOTE

*When changing NAV angle, be aware that the DTK for an approach does not change on the active flight plan until you reload the approach.*

Selected NAV angle units are applied to all angular values.

Options:

<p style="text-align: center;"><b>Magnetic</b></p> <p>Corrects all track, course, and heading information to the magnetic variation computed by the GPS receiver.</p>	<p style="text-align: center;"><b>External</b></p> <p>Synchronizes GTN NAV angle with the on-side MFD. Availability is dependent upon configuration.</p>
<p style="text-align: center;"><b>True</b></p> <p>References all information to true north.</p>	<p style="text-align: center;"><b>User</b></p> <p>Allows you to manually set a magnetic variation value between 0° and 179° E or W.</p>

## Position Formats

The selected format is used in all locations where position information is available.

Format detail is as follows.

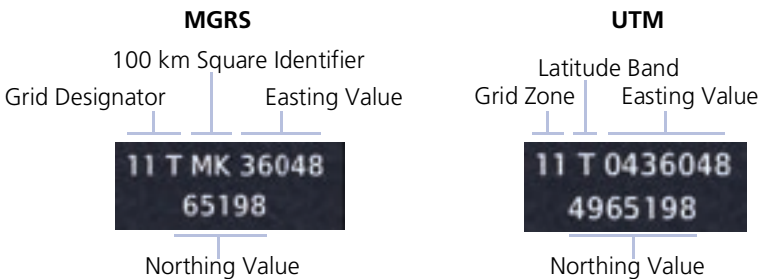

## REGIONAL POSITION FORMATS

By default, GTN displays lat/lon for any positions outside the grid region.

### British National Grid

Grid Designator      Easting Value

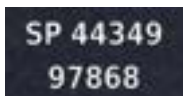

A dark rectangular display showing the British National Grid coordinates. The top line contains the grid designator 'SP' followed by the easting value '44349'. The bottom line contains the northing value '97868'. Light blue lines with vertical stems connect the labels 'Grid Designator', 'Easting Value', and 'Northing Value' to their respective parts of the display.

Northing Value

### Irish National Grid

Grid Designator      Easting Value



A dark rectangular display showing the Irish National Grid coordinates. The top line contains the grid designator 'R' followed by the easting value '51544'. The bottom line contains the northing value '37202'. Light blue lines with vertical stems connect the labels 'Grid Designator', 'Easting Value', and 'Northing Value' to their respective parts of the display.

Northing Value

### Swiss National Grid

Easting Value

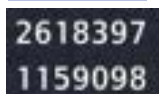

A dark rectangular display showing the Swiss National Grid coordinates. The top line contains the easting value '2618397'. The bottom line contains the northing value '1159098'. Light blue lines with vertical stems connect the labels 'Easting Value' and 'Northing Value' to their respective parts of the display.

Northing Value

# Click Volume



Your GTN is wired for audio output. Set the click volume to the preferred level.

## Click Volume Control

Percent of  
Max Volume



Volume displays as a percentage of the maximum volume, with 0% being muted and 100% being maximum volume.

Decrease  
Volume

Increase  
Volume

## HTAWS Voice Alert Options

### FEATURE REQUIREMENTS

- HTAWS

An optional voice callouts may be available for units configured for HTAWS alerting.

To set the volume, tap **Voice Callouts** > **MAX Voice Callout**, and set a value.

### Voice Callout Availability

- Down to 100 ft above terrain when HTAWS is present and GSL above terrain is used to generate callouts (no radar altimeter)
- Down to 50 ft above terrain when a radar altimeter is present and supplying the height above terrain to generate callouts

# Display Brightness Control



Depending on configuration, display brightness is controlled using inputs from the built in photocell, aircraft dimmer bus, or both.

## Automatic Brightness Control

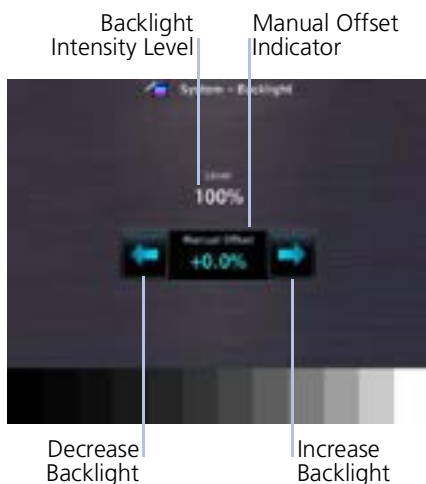

Dimming is limited to prevent on-screen indications from becoming unreadable. The built in photocell automatically controls display brightness based on ambient light levels.

During automatic control, the pilot may still adjust brightness using the manual offset controls in the Backlight page.

The unit retains manual offset settings over power cycles.

## Manual Brightness Control

Optionally, the unit is configurable to use an aircraft dimming bus for display brightness control. Upon reaching minimum input level, display brightness reverts to the photocell. This prevents the display from going black in the event of a dimmer input failure.

Installer configured curves determine the amount of change in brightness that occurs in response to a control adjustment.

If brightness control is not satisfactory, contact a Garmin dealer to adjust the lighting curves.

# Scheduled Messages



Create custom reminder messages and set when they will display. Allows one time, periodic, and event-based message types.

## WHERE TO FIND IT

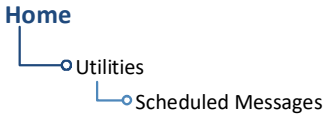

Active reminders appear at the top of the scheduled message list. This list is accessible via the Utilities menu page.

Examples: • “Call FBO” • “Close flight plan” • “Switch fuel tanks”

## CREATE A REMINDER MESSAGE

1. Tap **Create Scheduled Message**.
2. Specify the message type, content, and countdown timer value.

## Message Types

TYPE	DISPLAYS...
One time	When the timer expires, or following each power cycle until message deletion.
Periodic	After a specified duration of time. Countdown repeats once the message displays.
Event	According to a specified date and time. Message timer not applicable.

## Modifying Scheduled Messages

Once created, these messages may be modified at any time. Selecting a scheduled message opens an options menu.

### EDIT MESSAGE

This function is accessible from either the Scheduled Messages page or the system message list.

### RESET TIMER

Restarts the countdown timer.

### DELETE MESSAGE

Confirming this request removes the selected message from the list.

# Crossfill

## FEATURE REQUIREMENTS

- *Dual GTN configuration*

Enable the crossfilling of information between two GTN units.

## Crossfill Features

- Enabling this function on one GTN automatically enables it on the other.
- Some types of data crossfill regardless of the current setting

## WAYPOINT IDENTIFIERS

When crossfilled from GTN to GNS, duplicate waypoint names, or names exceeding six characters in length, are shortened. A “+” sign replaces certain characters while leaving significant characters to aid in identification (e.g., USR003 becomes US+003).

## GTN to GTN Data

Alerts:

- Traffic pop-up acknowledgment
- Missed approach waypoint popup acknowledgment
- Altitude leg pop-up acknowledgment

External Sensors:

- Synchro heading
- Transponder status and commands

Flight Plan Catalog

System Setup:

- User-defined NAV frequencies
- Date/Time convention
- Nearest airport criteria
- Units (Nav angle, Fuel, and Temperature)
- User-defined COM frequencies
- CDI Scale setting
- ILS CDI Capture setting

User waypoints

Includes active flight plan navigation data if you turn on the crossfill function.

If configured, a system message alerts you when the function off (i.e., flight plans are not crossfilling).

**To enable or disable crossfilling:**

Home > **System** > **Setup** > **Crossfill** > **OK**

## GTN to GNS Data

### GTN to GNS

Active flight plans  
Active direct to  
User waypoints

### GNS to GTN

User waypoints

**To enable crossfilling:**

Home > **System** > **Setup** > **GNS Crossfill Settings** > **Auto GNS Crossfill**

# Status Indications

## Alert Types

The unit generates annunciations in response to various conditions that may occur. These abbreviated messages are grouped according to the level of urgency and required response. They display in order of priority, from highest to lowest.

1. Warnings
2. Cautions
3. Mode & function advisories

### WARNINGS & CAUTIONS

Warnings require immediate attention. Cautions indicate the presence of an abnormal condition that may require pilot action. A warning may follow a caution if no attempt is made to correct the condition (e.g., altering the aircraft's path toward the alerted terrain or obstacle).

### MODE & FUNCTION ADVISORIES

Advisories provide status and operating information.

**System advisories.** These display on a dedicated message list. Depending on the number of advisories, this list may be scrollable.

**Function or mode specific advisories.** These appear as unobstructed annunciations in the annunciator bar.

For a complete list of all system-related advisories, refer to section 7.

## Alert Annunciations

Alert annunciations are abbreviated messages that indicate an alerted function or mode. The color of the annunciation depends on the alert type.

ALERT COLORS
<b>WARNING</b>
<b>CAUTION</b>
<b>ADVISORY</b>

- Warnings display in white text on red background
- Cautions display in black text on amber background
- Function or mode specific advisories display in black text on white background

When an alert is triggered, the annunciation flashes by alternating text and background colors. It turns solid after five seconds. All annunciations remain active (solid) until the condition is resolved or no longer a threat.

### ANNUNCIATION LOCATION

Alerts and informational advisories annunciate along the bottom of the screen.

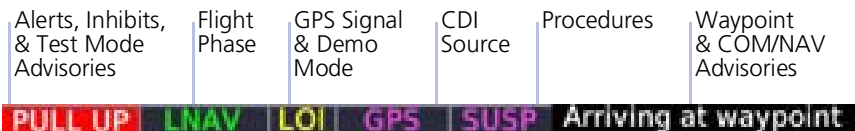

**Annunciator Bar**

## Pop-up Alerts

If a warning or caution relating to terrain or traffic occurs, a pop-up window may display. These pop-ups only appear if the alerted function's associated page is not active.

### Pop-up Alert Priority

In the event of simultaneous alerts, pop-up windows display in the following order:

1. Terrain alerts
2. Traffic alerts

Each pop-up alert provides:

- Threat indication
- Alert annunciation
- Option to inhibit or mute the alert
- Control for closing the pop-up window
- Direct access to the associated page

Traffic Pop-up, GTN 750Xi Series



Traffic Pop-up, GTN 650Xi Series



**Pop-up Alert Layout**

<b>1</b>	Enlarged Page View	<b>3</b>	Close Pop-up Window Key
<b>2</b>	Threat Indication	<b>4</b>	Go to <Page> Key

To open the indicated page, tap **Go to <Page>**.

To acknowledge the alert and return to previous page view, tap **Close**.

## Aural Alerts

Some alerts are accompanied by an aural voice message. Voice gender is configured during installation. To determine which alerts provide aural indications, refer to the applicable alerts table(s) in the Hazard Awareness section.

# System Status



View information specific to the unit and its software. Refer here when contacting customer service.

## SYSTEM INFO

- Serial number
- System ID
- Main software version
- GPS/WAAS software version
- COM board software version (GTN 635Xi, 650Xi, 750Xi only)
- NAV board software version (GTN 650Xi, 750Xi)

## CONTROLS

Database Info access keys:

- **Active**
- **Standby**

For more about active and standby databases, read *Databases*.

# GPS Status



Monitor GPS receiver performance, establish a baseline for normal system operation, and troubleshoot weak or missing signal issues.

This page provides a visual reference of GPS receiver functions, including:

- Current satellite coverage
- Phase of flight
- Present position (latitude and longitude)
- GPS solution and receiver status
- Position accuracy

## SKY VIEW DISPLAY



- Depicts satellites currently in view as well as their respective positions
- Outer circle represents the horizon (with north at the top of the circle)
- Inner circle represents 45° above the horizon
- Center point shows the position directly overhead

## SIGNAL STRENGTH INDICATIONS

### Satellite SVIDs

Each bar is labeled with the SVID of the corresponding satellite. Numbers vary according to satellite type.

- GPS: 1 to 31
- SBAS: 120 to 138

A graph shows GPS signal strength for up to 15 satellites. As the GPS receiver locks onto satellites, a signal strength bar appears for each satellite in view.

Graph symbols depict the progress of satellite acquisition. Some data may not display until the unit has acquired enough satellites for a fix.



SYMBOL	CONDITION
Not present	Receiver is searching for the indicated satellites.
Gray bar, empty	Satellite located.
Gray bar, solid	Satellite located, receiver is collecting data.
Yellow bar, solid	Data collected, but satellite is excluded from position solution (i.e., it is not in use).
Cyan bar, cross-hatch	Satellite located, but FDE excludes it for being a faulty satellite.
Cyan bar, solid	Data collected, but receiver is not using satellite in the position solution.
Green bar, solid	Data collected, satellite in use in the current position solution.
D (inside bar)	Differential corrections are in use (e.g., WAAS).

## POSITION ACCURACY FIELDS

LABEL	POSITION DATA
EPU	Estimated Position Uncertainty
HDOP	Horizontal Dilution of Precision
HFOM	Horizontal Figure of Merit
VFOM	Vertical Figure of Merit

EPU is the horizontal position error estimated by the fault detection and exclusion algorithm, in feet or meters.

Information fields indicate the accuracy of the position fix.

HFOM and VFOM values represent 95% confidence levels in horizontal and vertical accuracy.

Lower values mean higher accuracy. Higher values are the least accurate.

## FDE PREDICTION



### NOTE

*Under FAR parts 91, 121, 125, and 135, FDE must be used prior to all oceanic or remote area flights using GTN as a primary means of navigation.*

This program uses an algorithm to predict FDE availability. If the unit has not been in operation for more than six months, acquiring satellite data to establish almanac and satellite orbit information may take 5 to 10 minutes.

## Circle of Uncertainty

### FEATURE LIMITATIONS

- Available only when the aircraft is on ground
- Displays only on Map

Circle of Uncertainty



- Depicts area surrounding the ownship when GPS cannot accurately determine aircraft location
- Expands as GPS horizontal accuracy degrades
- Shrinks as accuracy improves
- Translucent with minor shading so as not to obstruct other features

## SBAS Providers



### NOTE

*Operating with SBAS active outside of the service area may cause elevated EPU values to display on the status page. Regardless of the EPU value displayed, the LOI annunciation is the controlling indication for determining the integrity of the GPS navigation solution.*



SBAS supports wide area or regional augmentation through the use of additional satellite broadcast messages.

Tap this key and select from the list of providers.

PROVIDER	SERVICE AREAS
EGNOS	Most of Europe and parts of North Africa.
GAGAN	India
MSAS	Japan only.
WAAS	Alaska, Canada, the 48 contiguous states, and most of Central America.

## GPS Status Annunciations

Once the GPS receiver determines the aircraft’s position, the unit displays position, altitude, track, and ground speed data. GPS status annunciates under the following conditions.

ANNUNCIATION	CONDITION
Acquiring	GPS receiver uses last known position and satellite orbital data (collected continuously from satellites) to determine which satellites should be in view.
3D Nav	3-D navigation mode. GPS receiver computes altitude using satellite data.
3D Diff Nav	3-D navigation mode. Differential corrections from SBAS provider are in use.
LOI	Satellite coverage is insufficient to pass built-in integrity monitoring tests.

## GPS Alerts

The following alert conditions can affect GPS accuracy.

INDICATIONS	FAULT TYPE	CONDITION
Yellow "LOI" annunciation.	Loss of Integrity	Integrity of the GPS position does not meet the requirements for the current phase of flight. Occurs before the final approach fix (if an approach is active).
Unit invalidates active course guidance. Annunciation is specific to cause.	Loss of Navigation	Aircraft is after the final approach fix and GPS integrity does not meet the active approach requirements.
		Insufficient number of satellites supporting aircraft position (i.e., more than 5 seconds pass without adequate satellites to compute a position).
		GPS sensor detects an excessive position error or failure that cannot be excluded within the time to alert.
		On-board hardware failure.
Yellow "No GPS Position" annunciation. Ownship icon not present	Loss of Position	Unit cannot determine a GPS position solution.

For information about managing limited navigation features, read *Dead Reckoning* in section 3.

# LRU Status



Devices that interface to the system via Ethernet display product information and connection status on the External LRUs list.



The device is configured and communicating properly.



The device is not available and is not configured, or it is not communicating properly.



Some interfaced equipment provide controls for product registration, enablement, or viewing detailed status information.

To access these features, tap **More Info**.

# Logs

## Export to SD Card



Export a flight data log to an SD card for later analysis.

### FEATURE REQUIREMENTS

- *SD card*

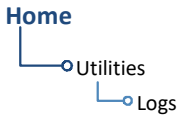

To export a diagnostic log:

1. Insert an SD card.
2. Tap **Utilities > Logs**.
3. Select **WAAS Diagnostic Log** or **Flight Data Log**.

If no log files are present, these keys are not available.

### WAAS Diagnostic Log Functions

- Generates log files automatically upon unit power-up
- Overwrites oldest file when the internal log reaches capacity
- Exports to the “logs” folder on the SD card

### Flight Data Log

- Generates log files automatically upon unit power-up
- Overwrites oldest file when the internal log reaches capacity
- Exports to the “logs” folder on the SD card

INTENTIONALLY LEFT BLANK

# 3 Navigation

MAP.....	3-4
CHARTS.....	3-42
ACTIVE FLIGHT PLAN .....	3-48
DIRECT TO.....	3-79
WAYPOINTS.....	3-89
PROCEDURES.....	3-109

### NAVIGATION APPS & FUNCTIONS

Selections vary based on features and optional equipment installed with Garmin avionics.

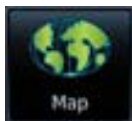

#### Map

- Display moving map
- Adjust detail level
- Customize map overlay features
- Edit user fields
- Graphically edit a flight plan
- Select a CDI source (GTN 750Xi only)



#### Charts

- View terminal procedures & airport surface diagrams



#### Waypoint Info

- Search waypoints
- Create & store user waypoints

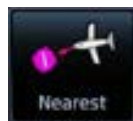

#### Nearest

- View nearest waypoints, airspace, or facilities



### Flight Plan

- Create & edit a flight plan
- View active leg status
- Catalog & manage saved flight plans
- Specify a parallel course offset
- Import a flight plan



### Procedures

- Load & activate procedures
- Activate a missed approach



### Direct To

- Set a direct course to any waypoint
- Generate a custom hold
- Generate a search-and-rescue pattern



### GTN 650Xi SERIES

#### Default NAV

- Configure user fields
- Enable OBS mode
- Select a CDI source (GTN 650Xi only)

# Map

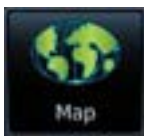

To increase situational awareness, Map depicts the aircraft's current position relative to land, aeronautical, weather, and traffic information.

### FEATURE REQUIREMENTS

- *Active GPS source (aircraft position symbol)*
- *Active weather subscription (Connex & SiriusXM only)*
- *FIS-B and GDL 88 or GTX 345 (FIS-B Weather)*
- *GDL 69/69A SiriusXM receiver (SiriusXM Weather)*
- *GDL 69, GDL 88, GTX 345, or GSR 56, with appropriate weather service subscription (NEXRAD/PRECIP overlay)*
- *GSR 56 Iridium satellite transceiver (Connex Weather)*
- *WX-series Stormscope receiver (Stormscope lightning data)*
- *Valid heading source (Radar, Stormscope & Traffic)*
- *Matching chart databases (dual GTN/crossfill configurations only)*
- *Traffic system*

*GTN 750Xi Series only:*

- *GWX 68/70/75/80 or ARINC 708 connected radar (airborne weather radar overlay)*
- *Valid charts database with effective database cycle; aircraft to be airborne (ChartView, FliteCharts)*

### FEATURE LIMITATIONS

- *NEXRAD/PRECIP, Radar, and Terrain overlay functions are mutually exclusive; enabling one automatically disables the other*
- *Radar, Stormscope, and Traffic overlays do not display if user navigation angles are active*



Default Map Features

1	<b>Aircraft Symbol</b> Depicts current aircraft position and orientation.
2	<b>Track Vector</b> Current ground track indication.
3	<b>Basemap</b> Presents a graphical depiction of land and water data.
4	<b>User Field</b> Customizable data field appearing in each corner of the map.
5	<b>NAV Range Ring</b> Displays current direction of travel on a rotating compass. Orientation: Magnetic north
6	<b>Map Range Indicator</b> Displays current map range in the upper left quadrant of the range ring (i.e., the distance from the aircraft to the range ring).
7	<b>North Indicator</b> Indicates True north.

8	<b>Map Orientation Label</b> Reflects the selected map orientation.
9	<b>Map Overlay Icons</b> Indicates status of overlays at the current map range. Includes: obstacles, power lines, precipitation, terrain, and traffic
10	<b>Zoom Scale</b> Displays the current magnification level.
11	<b>CDI &amp; GPS Nav Status Indicator</b> Lower bar presents a sliding lateral deviation indicator. Upper bar presents from, to, and next waypoints and active leg status annunciations.

### FEATURE LABELS

To maintain readability, map feature labels remain uniform at all zoom levels.

### TRAFFIC UNITS

System Units page selections do not affect the display of traffic on Map.

### LAND AND WATER DEPICTIONS

Land and water data are for general reference only. Data accuracy is not suitable for use as a primary navigation source. The information is intended to supplement and not replace official government charts and notices.

## DATA DRAWING ORDER

The electronic map draws data in order of priority, from highest (1) to lowest (36), with higher priority features drawn atop those of lower priority.

LEVEL	FEATURE
<b>1</b>	Traffic
<b>2</b>	Ownship
<b>3</b>	Flight Plan
<b>4</b>	TAWS Alerts
<b>5</b>	Weather Radar <sup>†</sup>
<b>6</b>	Charts <sup>†</sup>
<b>7</b>	Stormscope
<b>8</b>	Obstacles
<b>9</b>	Fuel Range Ring
<b>10</b>	TFRs
<b>11</b>	Freezing Levels
<b>12</b>	Cell Movement
<b>13</b>	Lightning
<b>14</b>	METARs
<b>15</b>	Winds Aloft
<b>16</b>	SIGMETs
<b>17</b>	AIRMETs
<b>18</b>	Cyclone Warning

LEVEL	FEATURE
<b>19</b>	County Warning
<b>20</b>	PIREPs
<b>21</b>	AIREPs
<b>22</b>	City Forecast
<b>23</b>	Surface Analysis
<b>24</b>	Airspace
<b>25</b>	Waypoints
<b>26</b>	Airways
<b>27</b>	Turbulence
<b>28</b>	Icing Potential
<b>29</b>	Echo Tops
<b>30</b>	NEXRAD
<b>31</b>	Cloud Tops
<b>32</b>	IR Satellite
<b>33</b>	SafeTaxi
<b>34</b>	Terrain
<b>35</b>	Basemap
<b>36</b>	Topo

<sup>†</sup> GTN 750Xi Series only.

# Map Setup

## Map Setup Tabs

- Map
- Aviation
- Airspace
- Land
- Traffic
- Weather

Overlay data controls reside in the Map menu. Selections are organized into six groups.

Changes to an overlay setting take effect immediately.

## Map Setup Menu

- Orientation
  - North Up
  - Track Up
  - Heading Up
- North Up Above
  - Set range
- Visual APPR Selector
  - Set selector range
- Auto Zoom [1]
- Auto Zoom Min
  - Set range
- Auto Zoom Max
  - Set range
- Track Vector Length
  - Set length
- Altitude Constraints
  - Select label display
- NAV Range Ring
- Fuel Range Ring [1]
- Fuel Reserve Time [2]
  - Set duration
- TOPO Scale [1]
- Point Obstacle Range
  - Set display range
- HOT Line Range
  - Set display range
- Chart Color Scheme
- Selected ALT Range Arc [1]
- Restore Defaults

## MAP SELECTIONS

All Map tab selections provide on/off and range setting options unless otherwise noted.

## RESTORE DEFAULTS

Located in the bottom of each list, this key restores all original factory settings for the active group tab.

[1] On/off functionality only.  
[2] Dependent upon Fuel Range Ring selection.

## Map Display Orientation

Set the orientation of the map display.

Tap **Menu > Map Setup > Orientation**, and select from the following options.

### North Up

Orients map to True north

### Track Up

Orients map to current aircraft GPS track

### Heading Up

Orients map to current aircraft heading (requires heading data source interface)

Map orientation label changes to reflect the selected orientation.

### Aircraft Symbol Position & Orientation

- The tip represents actual aircraft location
- Symbol type is dependent upon configuration
- This feature is absent if a GPS source is not available

North Up is useful when zoomed out to view the entire route or a frontal system on a NEXRAD display.

## North Up Above

Sets the range at which map orientation changes to North Up.

Using the North Up Above feature causes the screen to switch at certain zoom levels. This is useful as a shortcut to quickly increase situational awareness.

## Visual Approach



Visual Approach  
Key

Sets the distance from the destination airport at which the **Visual Approach** selector key becomes active.



## Auto Zoom

Automatically adjusts Map to display the next waypoint in flight plan at the closest possible map range.



*Auto zoom presents SafeTaxi data while aircraft is on ground.*

Automatic functionality is overridden during manual zoom interactions. It resumes when:

- Another waypoint is in sequence
- Aircraft transitions from on ground to airborne
- Auto zoom range matches manual override range

### Local Auto Zoom (Rotorcraft Only)

Rotorcraft use a local auto zoom function where auto zoom will remain at the 1500 ft zoom scale until the helicopter is above 400 ft GSL or 40 kts.

Set minimum and maximum values to best meet operational needs.

## Track Vector

- Indication absent when aircraft velocity is < 30 kt

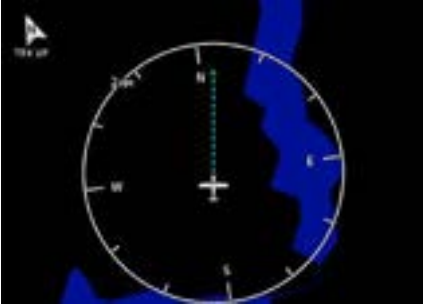

Indicates the current ground track.

Arrow tip represents aircraft position at the specified time interval (if the aircraft maintains current ground track during that time).

Track vector length options display as a dashed line and arrow extending from the aircraft icon, showing current track and distance the aircraft will travel in the selected time.

If the track vector is placed over a point on the map, and no data is entered into the system, the unit indicates a wind-corrected GPS track to that point. This is useful for intercepting airways and radials, making small but positive lateral corrections during approaches, and in setting up for arrivals in the terminal area.

## Altitude Constraints



Displays altitude constraint labels within the flight plan.

The active constraint is the altitude to which VNAV is currently providing guidance.

## NAV Range Ring

Provides a more precise indication of distance between the aircraft and map objects.

*On Setting*



*Enhanced Setting*



## Fuel Range Ring

### FEATURE REQUIREMENTS

- A Garmin EIS
- Third-party fuel systems

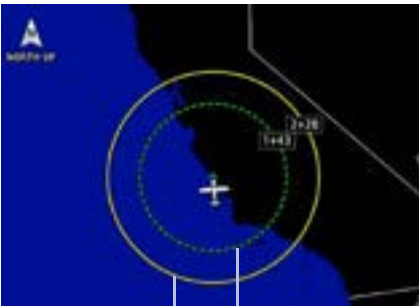

Range to Empty

Range to Reserve  
Fuel

- Estimates the remaining range at the current fuel consumption rate and ground speed.
- Calculations are based on the pilot specified fuel quantity in the fuel computer
- Dashed green circle indicates selected range to reserve fuel
- Solid yellow circle indicates total endurance range

## TOPO Scale



Scale Location

Displays a topographical elevation scale. To remove the scale, toggle **TOPO Scale** off.



## Chart Color Scheme

### GTN 750Xi SERIES

Toggles chart color scheme between day and night modes.

Day



Night



## Selected Altitude Range Arc

### FEATURE REQUIREMENTS

- A Garmin Display Unit



Represents location at which the aircraft is expected to reach selected altitude.

# Aviation Selections

## Aviation Menu

- Heliports
- SafeTaxi Diagrams
- Runway Extensions
- Intersection Range
- NDB Range
- VOR Range
- VRP Range
- User Waypoint Range
- Airway Range
- TFR
- Restore Defaults

Setup options allow you to customize the display of aeronautical information.

- Enable heliports and TFRs
- Specify airway types and range values
- Customize the display of SafeTaxi and waypoint data
- Display runway extensions for a destination airport

With the exception of Heliports and TFRs, all Aviation tab selections provide on/off and range setting options.

The runway feature extends the runway’s centerline out 5 NM from the runway threshold. This is useful when setting up for a visual approach, especially at airports with parallel runways or low visibility.

## AVIATION DATA SYMBOLS

	Non-towered, non-serviced airport [1]		Non-towered, serviced airport [1]
	Towered, non-serviced airport [1]		Towered, serviced airport [1]
	Soft surface, non-serviced airport		Soft surface, serviced airport
	Restricted (private) airport		Unknown airport
	Heliport		ILS/DME or DME only
	Intersection		LOM
	NDB		TACAN
	VOR		VOR/DME
	VORTAC		VRP
	User Airport		User Waypoint
	Runway extension		ATK

[1] Symbol depicts orientation of longest runway.

# SafeTaxi



Zoomed In

SafeTaxi provides greater map detail and higher image resolution at lower zoom levels.







Feature labels denote:

- Runways
- Taxiways
- Airport landmarks

## SafeTaxi Features

- Airport diagram overlay that includes hot spot information
- Aircraft position relative to taxiways, runways, and airport landmarks
- Pilot selectable range options

## SAFETAXI DATA SYMBOLS

	Runway		Taxiway
	Helipad		Construction Area
	Airport Beacon		Unpaved Parking

## HOT SPOTS

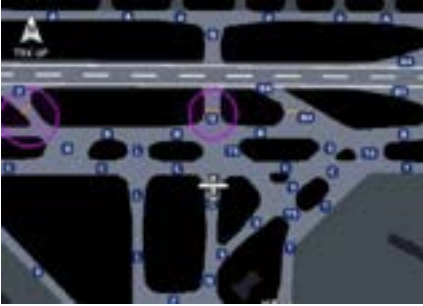

SafeTaxi hot spots identify locations on an airport surface where positional confusion or runway incursions are likely to occur. These known problem areas require heightened attention by pilots.



Selecting the border of a hot spot displays a brief summary of the indicated hazard and an information key.



Tapping this key provides additional location information. Numbering corresponds to a list on the airport diagram.



The following airport features may be deemed hot spots by aviation authorities.

- Intersecting taxiways and runways
- Complex ramp areas
- Directional limitations
- Limited wing-tip clearance
- Overflight risk

## CONSTRUCTION SPOTS



Construction Area Border

There are no expanded detail keys or notes associated with construction areas.

## Airspace Selections

### Airspace Menu

- Airspace Label Range
- Smart Airspace
- Show Airspaces
  - Select filter
- Class B/TMA/AWY Range
- Class C/CTA Range
- Class A/D Range
- Restricted Range
- MOA (Military) Range
- Other Range
- Restore Defaults

Filter airspace data according to altitude. The control for enabling smart airspace functionality also resides here.

With the exception of Smart Airspace, all Airspace tab selections provide on/off and range setting options.

# Smart Airspace

Garmin's Smart Airspace feature automatically de-emphasizes non-pertinent airspace away from the aircraft's current altitude.

Smart Airspace off



When an airspace's vertical proximity to the aircraft is >1,000 ft:

- Its boundary becomes transparent
- All associated altitude labels turn gray

This range increases linearly to 2,000 ft as the aircraft ascends to 10,000 ft.

Smart Airspace on



Non-pertinent Airspace

## SMART AIRSPACE CRITERIA

AIRCRAFT ALTITUDE	AIRSPACE PROXIMITY TO AIRCRAFT <sup>[1]</sup>
Sea level	>1,000 ft
>10,000 ft	2,000 ft

<sup>†</sup> Vertical distance above and below aircraft altitude.

## AIRSPACE DATA SYMBOLS



Class B Altitude Label (ceiling/floor)



Class C/TCA



Class C Altitude Label (ceiling/floor)



Class D



Class D Altitude Label (ceiling only)

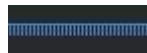

Restricted/Prohibited



TFR

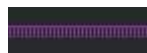

MIL



Class B/TMA



Other/ADIZ

# Land Selections

## Land Menu

- Road Detail
- City Detail
- State/Province Names
- River/Lake Detail
- Restore Defaults

Filter the display of land features according to detail level.

With the exception of State Province Names, all Land tab selections provide detail setting options.

## LAND DATA SYMBOLS



Railroad



National Highway



River/Lake



Freeway



State/Province Border



Small City



Local Road



Medium City



Local Highway



Large City

# Traffic & Weather Selections

## TRAFFIC

### Traffic Menu



Filter traffic data according to type. Other selections include on/off and range setting options.

## WEATHER

### Datalink Weather Menu

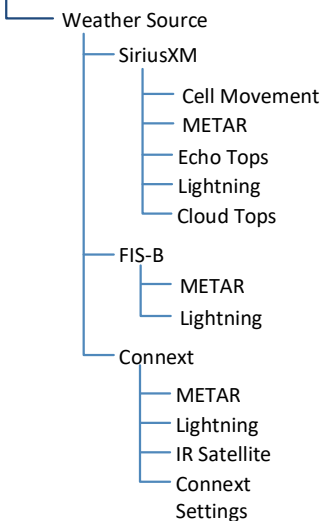

Setup options are available for all active weather services.

- Specify a datalink weather source
- Toggle individual weather products on/off

# Map Interactions

## Basic Interactions

Typical map interactions include zoom, pan, and object selection.

### PAN & ZOOM

Panning allows movement of the map in any direction without change to the current zoom setting. Zooming adjusts the current magnification level between pre-defined range parameters.

Before flight, consider which map scales are best for achieving the desired level of detail and map information.

Generally, use smaller map scales in and around terminal areas and whenever precise navigation is required (e.g., airway or radial intercepts).

During cruise flight, increase the map scale to better balance navigation, situational awareness, and decision making.

### OBJECT SELECTION

Tapping any object or location on the map displays a map pointer and an information banner.

### MAP POINTER



This symbol indicates point of contact on the map. A gray circle highlights any selected waypoint or obstacle.

## MAP INFO

Available information and controls are dependent upon object or location type and proximity to other objects.

Selecting an airport icon displays the airport’s highest field elevation. A map pointer icon corresponds with the touch point on the map.

Selected Airport



An information page access key displays when you select a waypoint, airspace, airport, airport surface hot spot, or TFR.



### DATA FIELDS

- Pan mode annunciation
- Bearing and distance from current aircraft position to map pointer
- Location elevation
- Maximum altitude AGL and MSL for obstacles

### CONTROLS

- **Map Pointer/Create Waypoint**
- **Graphical Edit**
- **Next** (for stacked objects)
- Associated information page access key, if applicable

## STACKED OBJECTS



To move the selector through each object in proximity of the map pointer, select an object and tap **Next**.



Overlapping objects may be difficult to identify at a given zoom level.

## AIRSPACE INFO

Selected  
Airspace



When selected, active airspace boundaries change color.

Tapping **Airspace Info** opens the associated information page.



Data fields display information specific to the selected airspace.

### GTN 650Xi SERIES

Tapping **Preview** displays the airspace boundary and a 2-D map of the surrounding area.



### DATA FIELDS

- Airspace name and type icon
- ATC entity responsible for the airspace, if applicable
- Floor and ceiling altitudes
- Proximity to airspace
- Airspace boundary on a 2-D map

### CONTROLS

- **Frequencies:** View a list of all related radio frequencies

# Graphical Flight Plan Editing

## FEATURE LIMITATIONS

- Parallel track offsets do not apply to the temporary flight plan



Graphical editing allows quick changes to the active flight plan from the map display.



Map provides identifier keys for selecting waypoints that are stacked or in close proximity.

If the displayed options are not preferred, tap away or select **Cancel**.

## TEMPORARY FLIGHT PLAN BANNER

An information banner displays waypoint selections made during graphical edit mode. All selections become active once you tap **Done**.

*Lists up to five waypoint identifiers*



Ellipse indicates additional waypoints

Initial waypoint in flight plan always appears first



Tapping **Undo** reverses the last edit. You may undo up to nine of the most recent actions.

On the map, dragging and releasing the leg away from any waypoints removes it from the temporary flight plan.

To exit edit mode without saving changes, tap **Cancel**.

## ADD WAYPOINT TO AN EXISTING LEG

Existing Leg



You can edit, add, or omit flight plan legs by tapping or dragging your finger directly on the map.

Selected Waypoint



1. Tap any location on the map.
2. Tap **Graphical Edit**.





3. Tap and drag the leg to a new waypoint or airway, then release.

New Route



The temporary flight plan adjusts to show the new route.

If no other edits are necessary, tap **Done**.

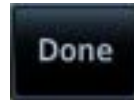

The new waypoint now appears in the active flight plan.

Active Leg



Active route identifiers also appear on the GPS NAV status indicator.

If configured, a user field shows active route identifiers on Map.



Delete any existing flight plan before attempting to graphically edit a direct-to waypoint. Map does not allow the addition of an intermediate waypoint between the current position and a direct-to waypoint unless the waypoint is in the flight plan.

## REMOVE WAYPOINT FROM FLIGHT PLAN



You can tap and drag any leg to another waypoint or airway, or release it away from any waypoint if an alternate destination is not preferred.



## CREATE LEGS WITHOUT AN EXISTING FLIGHT PLAN

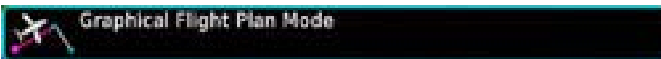

If an active flight plan does not exist, you can graphically create one without ever leaving Map.

1. Tap any location on the map > **Graphical Edit**.
2. Begin tapping waypoints to add them to the temporary flight plan.
3. Tap **Done**.

# Map Overlays

## Overlay Selections

- TOPO
- Terrain
- Traffic
- NEXRAD
- Charts
- Stormscope
- Airways
- Radar

Overlay data controls reside in the Map menu. Changes to an overlay setting take effect immediately.

NEXRAD and Terrain overlays are mutually exclusive. Enabling one automatically disables the other.

## Overlay Controls



Control keys enable the specified overlay function only and do not activate interfaced equipment. Control keys remain active even in the absence of required data.

Overlay controls reside in the Map menu.

## TOPO



- Overlays topographical data and ground elevation scale
- Depictions are similar to a VFR sectional
- Pilot-selectable topographical elevation scale available

## TERRAIN

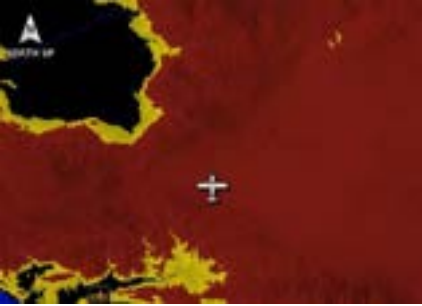

- Overlays terrain map data
- Color shading depicts terrain elevation relative to the aircraft's altitude

## TRAFFIC



- Overlays traffic information
- Filter selection on the Traffic page determines altitude range
- Feature optional

## NEXRAD



- Overlays datalink precipitation weather information
- Options dependent on weather data source
- Feature optional

## CHARTS



Arrival and departure chart overlays are not available.

- Overlays geo-referenced chart information
- Approach chart for the active flight plan in the navigator
- Airport surface chart if nearest airport is within 200 nm and no approach is active
- Depicts planview area only; excludes inset information (e.g., missed approach procedure view)
- Feature optional



### NOTE

*In the case of a dual GTN/crossfill configuration, the chart database on each unit must be of the same type and version in order for the correct chart to display on Map.*

## STORMSCOPE



- Overlays Stormscope lightning information
- Feature optional

## AIRWAYS



- Overlays the selected airway type(s) with identifier labels
- Options include: low, high, all, or off (none)
- High altitude airways are green, low altitude airways are gray

## RADAR



- Overlays airborne weather radar information
- Depictions are identical to those on the Weather Radar display
- Excludes WATCH shading
- Feature optional

## Overlay Status Icons

Icons indicate which overlays are present at the current map range. A crossed out icon means the overlay is active, but data is unavailable due to a failure, test, or standby condition (where relevant).

The absence of an overlay icon means one of two possible conditions:

1. Overlay not present at the current detail level or zoom setting.
2. Overlay control is off.



Obstacle



Power Line



Stormscope Lightning



Traffic



Terrain



Data not available

# User Fields

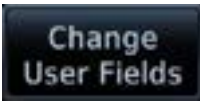

User fields allow you to customize the display of data in each corner of the map. Tap **Change User Fields** to access available options.



In configuration mode:

- All four data fields change to selectable keys
- All other map elements are inactive

Tap a key and select from the available data types.

## USER FIELD TYPES

Options are organized into three selectable menu tabs:

### Data

Lists available data fields (e.g., distance, bearing, desired track).



### Function

Lists available controls.



### Page

Lists available page access keys. These keys provide direct access to the specified page.



## Navigation

### Data Tab Options:

Available field types and their corresponding labels are as follows:

ACTV WPT	Active Waypoint	MSA	Minimum Safe Altitude
BRG	Bearing to waypoint	NAV/COM	Active NAV/COM Frequency
D/B APT	Distance/bearing from destination airport (i.e., the straight line distance)	OAT (static)	Outside static air temperature
DIS	Distance to waypoint	OAT (total)	Outside total air temperature
DIS to Dest	Distance to destination (i.e., the distance along the flight plan)	TKE	Track angle error
DTK	Desired track	TRK	Track
ESA	En route safe altitude	Time	Current time
ETA	Estimated time of arrival	Time to TOD	Time to top of descent
ETA at Dest	ETA at destination	Trip Timer	Timer display
ETE	Estimated time en route	VOR/LOC	Tuned VOR/LOC information
ETE to Dest	ETE to destination	VSR	Vertical speed required
Fuel Flow	Total Fuel Flow	Wind	Wind speed and direction
GS	GPS ground speed	XTK	Cross track error
GSL	GPS Altitude	OFF	Do not display data field
Generic Timer	Timer display		

“Destination” refers to the missed approach point (if an approach is loaded) or the final airport in the flight plan.

### Function Tab Options:

Course Deviation Indicator	OBS/Suspend/Unsuspend key
Flap Override key <sup>†</sup>	On Scene mode key
GPWS Inhibit key <sup>†</sup>	TAWS Inhibit key
G/S Inhibit key <sup>†</sup>	Generic Timer Control
HTAWS RP Mode key <sup>‡</sup>	OFF

<sup>†</sup> Available when TAWS-A is active.

<sup>‡</sup> Available when HTAWS is active.

**Page Tab Options:**

- Active Flight Plan • Approach • Arrival • Checklist • Connex Weather
- Default Navigation • Departure • FIS-B Weather • Fuel Planning • Map • Nearest
- Nearest Airport • Procedures • Scheduled Messages • Services • Sirius XM Weather
- Stormscope • Terrain • Traffic • Trip Planning • Utilities • User Frequencies • VCALC
- Waypoint Information • Weather • OFF

**TOPO SCALE & USER FIELDS**

**GTN 650Xi SERIES**

When active, the topographic scale replaces the bottom left user field.

To view this field, turn off TOPO Scale (Tap **Menu > Map Setup > TOPO Scale**).

*TOPO scale off*



*TOPO scale on*



User Field Absent

**TURN OFF USER FIELDS**



Selecting "OFF" removes the corresponding user field from the map page.



User Fields Absent

### RESTORE DEFAULTS

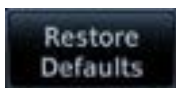

Tapping this key returns all fields to their default settings.

#### Default User Fields

- DIS - Distance
- GS - Ground Speed
- DTK - Desired Track
- TRK - Track
- BRG - Bearing<sup>†</sup>
- ETE - Estimated time en route<sup>†</sup>

User fields are useful during time sensitive and work load intense phases of flight.

<sup>†</sup> GTN 650Xi Series only.

### GTN 650Xi SERIES



You can configure additional user fields for display on the Default Navigation page. Options are identical to those available on Map.

Home > **Default NAV** > **Menu** > **Configure User Fields**



*Bottom row user fields allow Data tab selections only.*

Tap **Map** to view and configure user fields on moving map.



# Map Detail

Changes to the map detail level take effect immediately. Options include:

- Full
- High
- Medium
- Low

FEATURE	FULL	HIGH	MEDIUM	LOW
Small Cities				
Medium Cities				
Large Cities				
Freeways				
Highways				
Roads				
Railroads				
Basemap Labels				
VORs				
NDBs				
Line Obstacles				
Point Obstacles				
Airspaces that are not prohibited or restricted				
Waypoints				
SafeTaxi				
Restricted Airspaces				
Prohibited Airspaces				
Airways				
Active Flight Plan				

**Present**

**Removed**

# Charts



The Charts page provides terminal procedures and airport surface diagrams.

### FEATURE REQUIREMENTS

- A current and valid chart database

### FEATURE LIMITATIONS

- Geo-referencing is not available for some arrival and departure charts
- FliteCharts and ChartView databases are optional and mutually exclusive

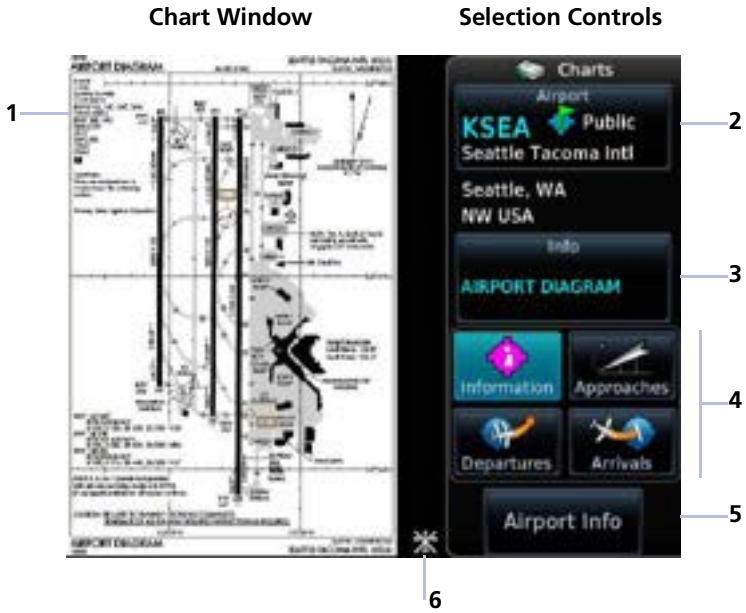

1	Chart	4	Chart Type Selection Keys
2	Airports Selection Key	5	Airport Info Key
3	Charts Selection Key	6	Position Unavailable Icon

## CHARTVIEW INFORMATION SECTIONS

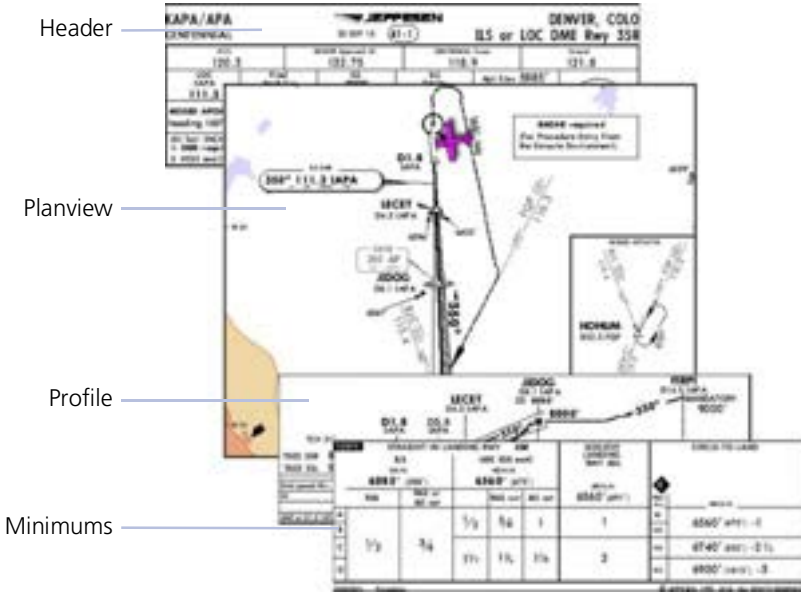

## CHART STATUS

Active chart status displays at the bottom of the Charts display.

**Getting Newer Charts**

Charts are in the process up updating.

**Charts Changed**

Charts are up to date.

**Expired 28-Apr-2016**

Database is out of date.

**Not Effective Until 31-Mar-2016**

Database is installed before it is current.

# Chart Setup

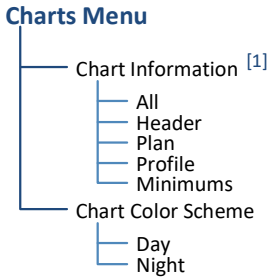

[1] ChartView only.

Tap **Menu** to access setup selections.

From here you can:

- View individual chart sections (ChartView only)
- Change the chart's color scheme for day or night viewing

<b>Chart Information</b>	Displays individual sections of a chart in the ChartView database only. Options include: <ul style="list-style-type: none"><li>• All</li><li>• Header</li><li>• Planview</li><li>• Profile</li><li>• Minimums</li></ul>
<b>Invert Colors</b>	Toggles chart color scheme between day and night modes. <ul style="list-style-type: none"><li>• Day mode displays black on white background</li><li>• Night mode displays inverse white on black background</li></ul>

# Chart Selection



To select a chart:

1. Tap **Airports**.
2. Enter an airport identifier.
3. Choose from the available chart types.

## CHART TYPES



### Approach

All approach charts associated with the selected airport. Charts are listed according to level of precision and approach type. Runways are listed in numerical order.



### Arrival

Arrival procedure instructions. Arrival charts are listed in alphabetical order.



### Departure

Departure route descriptions, including takeoff minimums and obstacle notes.



### Information

Airport surface charts, alternate minimums, rate of climb and descent tables, inoperative components or visual aids tables, hot spots, land and hold-short operations, and other destination specific flight data.

Upon selecting a chart type, you have the following options:

- *Choose a specific chart:* Tap the associated menu key and choose from the list of available charts.
- *View airport waypoint information:* Tap **Airport Info**.
- *Zoom the chart display in or out:* Tap **In** or **Out**.

### AUTOMATIC CHART SELECTION

Automatic chart selection occurs every time the Charts page is opened. The type of chart selected is determined by aircraft status and content from the active flight plan. This function does not override manual chart selections unless a change occurs during one of the following conditions.

CONDITION	CHART DISPLAY DEFAULT
No flight plan or destination airport is present.	Nearest airport diagram.
Aircraft is on the ground.	Nearest airport diagram (regardless of flight plan).
Flight plan is present, but approach is not loaded.	Airport surface chart for previous airport in flight plan.
Approach is loaded in the selected GPS navigator.	Applicable approach chart.
No charts are available for a selected airport.	“Chart not available for [airport ID].”

# Aircraft Position Icon

## FEATURE REQUIREMENTS

- Aircraft position is fully within chart boundaries
- FliteCharts or ChartView is active (airborne maneuvers only)

## FEATURE LIMITATIONS

- SIDs and STARs do not support the display of aircraft position
- Not available for arrival and departure charts
- Displays only within the planview area of geo-referenced approach charts

Aircraft position displays on airport diagrams and approach charts when the current position is known.

## POSITION UNAVAILABLE INDICATION



A fault icon appears in the bottom right corner when:

- Aircraft position data is not available
- Backup GPS is in use
- Selected chart does not contain geo-referenced data
- Selected chart layer is not All or Planview

## OFF SCALE AREA

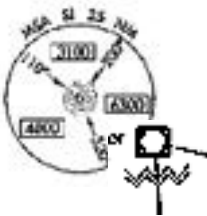

Some charts contain supplemental information within the planview. These areas are considered off scale as they are not geographically accurate.

Aircraft position depictions in off scale areas should be judged relative to the geo-referenced information within the planview only.

# Active Flight Plan



Current flight plan information displays as a scrolling list on the Active Flight Plan (FPL) app.

### FEATURE REQUIREMENTS

- Active flight plan

### FEATURE LIMITATIONS

- Displays up to 99 waypoints for an active flight plan



Active Flight Plan

1	Selectable Data Field Columns	5	Current Waypoint
2	Waypoint Identifier Column	6	Waypoint Type Icon
3	Procedure Header	7	Leg Data
4	Active Leg Indicator	8	Airport Info Key

## AIRPORT INFO

Procedure  
Header

Airport Info  
Key



For convenience, airport information is directly accessible from the procedure header. This includes airports specified in active approaches, arrivals, and departures.

Tap **Airport Info** to open the corresponding information page.



## FIX TYPE INDICATIONS

LABEL	FIX TYPE
iaf	Initial Approach Fix
faf	Final Approach Fix
map	Missed Approach Point
mahp	Missed Approach Hold Point
-p	Parallel Track (no fix)

When applicable, labels indicate the fix type associated with an identifier.

### ACTIVE LEG STATUS INDICATIONS

Magenta symbols denote active leg status on from/to/next waypoint indications. Fix type symbols (e.g., FAF, MAP) correspond with labels appearing on the flight plan.



IAF



Arc Left



FAF



Holding Pattern  
(Right Turns)



MAP



Holding Pattern  
(Left Turns)



MAHP



Active Leg Arrow



Parallel Track



Direct To



Arc Right

# Create a Flight Plan



## NOTE

*The unit cannot verify the accuracy of cataloged flight plans with modified procedures.*

There are three methods for creating a new flight plan.

## CREATE FROM THE ACTIVE FLIGHT PLAN PAGE

1. Tap **Flight Plan**.
2. Delete the existing flight plan if necessary (**Menu** > **Delete**).
3. Tap **Add Waypoint**.
4. Select an identifier using the provided search options.
5. Repeat steps 3 - 4 for each waypoint in the route.

## CREATE FROM MAP

Build a flight plan by selecting waypoints directly on the map using Map's Graphical Flight Plan mode.

## CREATE FROM THE FLIGHT PLAN CATALOG

1. Tap **Flight Plan** > **Menu** > **Catalog**.
2. Scroll to the end of the flight plan list.
3. Tap **Create New Catalog Route** > **Add Waypoint**.
4. Add waypoints using the provided search options.
5. Tap **Menu** > **Preview** > **Store** or **ACTV (Activate)**.

As a general practice, never save flight plans with modified procedures in the catalog.

# Airway Options

## Airway Options

- Collapse All Airways
- Select Airway
- Remove Airway

Selecting an airway from the active flight plan opens a menu. You may elect to:

- Collapse all legs of the airway
- Select a new airway
- Remove an airway from the flight plan

## Collapse All Airways

Airways automatically display as flight plan legs. A single airway may contain numerous legs. Airways without an active leg collapse for simplification. This does not affect airway legs shown on the external navigator(s).

Airway Indication

Expanded Airway Detail



All airways begin with an indicator field and end with an exit identifier.

To hide all waypoints along an airway, but not the airway's exit waypoint, tap **Collapse All Airways**.

Airway Collapsed Indication

Airway Collapsed Indication



## Sort Airways

Preview of a sorted airway waypoint list.



A toggle key allows you to sort the airway waypoint list alphabetically or by distance.

This option is available once you select an airway.



The sort function is useful when you are searching for an exit point from the airway.

# En Route Vertical Navigation



Create a vertical navigation (VNAV) path with multiple altitude constraints in the flight plan.

## FEATURE REQUIREMENTS

- *Enablement by the installer*
- *Baro-corrected altitude source*

## FEATURE LIMITATIONS

The following flight plan waypoints do not allow altitude constraints:

- *Legs containing headings*
- *Legs that terminate at an altitude (e.g., a climb to 1,800 ft before making a turn and proceeding direct to fix)*

Storing a flight plan in the catalog removes its altitude constraints.

## WHERE TO FIND IT

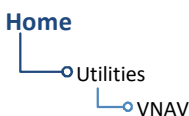

The vertical navigation (VNAV) feature provides vertical profile guidance during the descent phase of flight. Guidance is based on altitude constraints associated with lateral waypoints in the active flight plan.

This feature is also accessible via the Active Flight Plan menu (Home > **Flight Plan** > **Menu** > **VNAV**).

Annunciations display within 60 seconds of the top or bottom of descent. A “Vertical Track” aural message plays at 60 seconds from the top of descent.

## VNAV Functions

- Presents vertical path guidance to the descending path as either a line joining two waypoints with specified altitudes or a linear deviation from the desired path (i.e., the vertical angle from the specified waypoint or altitude)
- Integrates vertical waypoints into the active flight plan
- Supports both manual and autopilot coupling

For installation details related to en route vertical navigation, consult the AFMS.

## Define a VNAV Profile



Active vertical navigation profile information displays on the VNAV Profile page. From here you can:

- Enable en route vertical guidance
- Specify a target vertical speed and flight path angle
- View active constraint data
- Set a default FPA (in the VNAV Profile menu)

VS Target and FPA may be unavailable if the selected altitude is set higher than the Active VNAV Constraint **or** if the aircraft is more than 50 NM from the top of descent.

### ENABLE VNAV GUIDANCE

From the active flight plan:

Home > **Flight Plan** > **Menu** > **VNAV** > **VNAV Enabled**.

Tapping **VNAV** again toggles the function off.

#### Disabling vertical navigation:

- Invalidates required vertical speed, time to TOD/BOD, and vertical deviation data
- Removes vertical deviation and required vertical speed indications from the PFD

VNAV automatically re-enables when you initiate a direct course.

## Altitude Constraints

Altitude constraints are either entered manually into the Active Flight Plan page, or automatically retrieved from the published altitudes in the navigation database.

Altitude constraints loaded from the database are jet altitudes. Some adjustment may be necessary for other types of aircraft. For the adjustment procedure, refer to the published chart.

### ALTITUDE CONSTRAINT INDICATIONS

The system automatically uses altitudes loaded with arrival and approach procedures (up to and including the FAF) for computing vertical deviation guidance. These values, accompanied by an altitude restriction bar(s), display in cyan.

The position of the value (above or below the bar, or between two bars) denotes the required aircraft altitude relative to that constraint.

Dual values annunciate when the aircraft needs to cross between two altitudes.

Constraint values display in MSL or flight level (FL). Constraints at airports may be specified as MSL or AGL.

*Examples:*

**Cross at or Above 5,000 ft**



**Cross at or Below 5,000 ft**



**Cross at 5,000 ft**



**Cross Between 5,000 ft and 6,000 ft**



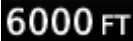

 A black rectangular box with the text "6000 FT" in white.

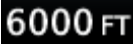
- Altitude calculated by system
- Estimate of aircraft altitude as it passes over the navigation point
- Absence of bar(s) indicates it is not a potential constraint

 A black rectangular box with the text "6000 FT" in white, with a horizontal bar above the text.

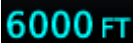
- Altitude retrieved from navigation database
- Bar above and/or below the value indicates constraint type
- Altitude is for reference only. Not for use in determining vertical guidance

 A black rectangular box with the text "6000 FT" in white, with a pencil icon to the left of the text.

- Altitude designated for use in determining vertical guidance
- Pencil icon indicates manual designation or manual data entry

 A black rectangular box with the text "6000 FT" in white, with a red 'X' over the text.

- Constraint invalid
- System cannot use altitude to determine vertical guidance

An altitude constraint is invalid if:

- Meeting the constraint requires the aircraft to climb
- Meeting the constraint requires the aircraft to exceed the maximum flight path angle (6° downward) or maximum vertical speed (-4,000 fpm)
- It results in a TOD behind the aircraft's current position
- It is within a leg type that does not support altitude constraints
- It is added to a waypoint past the FAF

### An altitude restriction displays when:

- A pilot-specified altitude constraint is deleted
- Navigation database contains an altitude restriction for the lateral waypoint
- A predicted altitude is not available

Once added to the flight plan, an altitude constraint may be modified or deleted using the controls in the VNAV Options menu. Select a value in the ALT column to display available options.

## ALTITUDE CONSTRAINT OPTIONS

SELECTION	FUNCTION
Type	<ul style="list-style-type: none"> <li>• Opens a list of available constraint types</li> <li>• Options: At, At or Above, At or Below, and Between</li> </ul>
Altitude Data Entry	<ul style="list-style-type: none"> <li>• Opens a keypad. Specify an altitude value for the selected constraint type</li> <li>• Unit options: MSL, AGL, and Flight Level</li> </ul>
Revert Constraint	<ul style="list-style-type: none"> <li>• Returns a modified altitude constraint to its original published value</li> </ul>
Remove Constraint	<ul style="list-style-type: none"> <li>• Removes the VNAV designation from the altitude</li> <li>• Value remains displayed for reference purposes. It is no longer used to compute vertical guidance</li> <li>• Removing the VNAV designation from an altitude may invalidate other displayed altitudes or cause them to change after recalculation</li> </ul>

### Designate a waypoint altitude for use with vertical guidance:

1. Select a waypoint altitude constraint.
2. Tap **Save**.

### Enter or modify an altitude constraint:

1. Select an altitude constraint.
2. Tap **Type** and select the constraint type.
3. Select the altitude data key.
4. Enter an altitude constraint value using the keypad.
5. Tap **Flight Level** to enter the value as a flight level.
6. Tap **Enter** to accept the altitude.
7. Tap **Save**.

### Delete an altitude constraint:

1. Select an altitude constraint.
2. Tap **Remove Constraint**.
3. Tap **OK**.

### Return a modified altitude constraint to its original database value:

1. Select an altitude constraint containing the pencil icon.
2. Tap **Revert Constraint**.
3. Tap **OK**.

## VNAV Direct To



This function creates a vertical navigation path from the aircraft's current position and altitude to a selected waypoint's location and altitude.

By removing any VNAV constraints between the aircraft and selected waypoint, it allows you to fly the lateral flight plan in a continuous descent and reach the waypoint at the specified altitude.

### ACTIVATE VNAV DIRECT TO

1. Select an altitude constraint.
2. Tap VNAV Direct To.
3. Confirm the request.

## Transition to Approach

### FEATURE LIMITATIONS

- *Function availability dependent upon installer configuration*

VNAV responds differently based on approach type.

### VNAV APPROACH RESPONSE

#### Transition to Approach enabled

- Vertical path attempts a smooth transition from en route to approach vertical guidance
- Aircraft intercepts with approach guidance from below the glidepath/glideslope

#### Transition to Approach not enabled

- En route VNAV terminates at the waypoint prior to the FAF on approaches with vertical guidance
- En route VNAV terminates at the FAF (LNAV only)

For more information about the transition to approach function, consult the AFMS.

# Temperature Compensated Altitude

Calculate loaded approach altitudes based on the pilot-specified destination temperature. Once you enter the destination temperature, GTN increases the approach altitudes accordingly.



### NOTE

*GTN and TXi displays use a single destination airport temperature for calculating compensated altitudes. Changing the temperature on one of these units automatically recalculates the value across all connected GTNs and GDUs.*

### FEATURE REQUIREMENTS

- Active flight plan contains a destination airport
- GDU 700( )/1060 for access via PFD Minimums menu

## SETTING TEMPERATURE COMPENSATED ALTITUDE

Controls for setting temperature compensation are accessible from two places:

- Active Flight Plan menu
- Minimums menu (PFD only)



Snowflake icon indicates temperature compensated FAF altitude.

To toggle function on or off, tap **Temperature Compensation**.

## ACTIVATE TEMPERATURE COMPENSATED ALTITUDE

**From the active flight plan:**

Tap **Menu > Temperature COMP > Temperature Compensation > TEMP at DEST**, and specify the destination airport temperature.

The temperature compensated FAF altitude annunciates in magenta.

# OBS



The Omni Bearing Selector (OBS) allows you to select between manual or automatic sequencing of waypoints.



When active, this function allows you to set the desired course To/From a waypoint using the provided controls or with an external OBS selector on HSI or CDI.

1. Tap **OBS**.
2. Specify a heading course.

## OBS Mode



CDI indicates the OBS heading. The mode displays on the annunciator bar.

The unit retains the active To waypoint as a navigation reference even after passing the waypoint (i.e., prevents sequencing to the next waypoint).

Tapping the key again resumes automatic sequencing of waypoints (normal mode).

# SUSPEND/UNSUSPEND



## SUSP

This key displays for leg types that do not support OBS.



## UNSUSP

This key displays for legs that auto suspend (e.g., leg holds, missed approaches).

# Dead Reckoning



## WARNING

*Do not use projected position data as the only means of navigation.*

### Points About Dead Reckoning

- Provides limited navigation using the last known position and speed following the loss of GPS navigation while on an active flight plan
- Becomes active after a loss of GPS position while navigating using an active flight plan and the flight phase is either En Route or Oceanic
- Allowed only during en route and oceanic phases of flight

### When dead reckoning mode is active:

- System flags all external outputs dependent upon GPS position data
- Map reports “No GPS Position”; overlays are not available
- “DR” appears over the ownship icon
- DR mode annunciation replaces ENR or OCN
- Terrain functionality is not available
- Traffic and Stormscope data display on their respective pages only
- CDI is not available

*Dead Reckoning Mode, GTN 650Xi*



Dead reckoning mode ends once GPS position is restored.

# Parallel Track

## Parallel Track

Create a parallel course offset relative to the current flight plan. Setup controls provide offset distance and direction setting (left of track or right of track).

### FEATURE REQUIREMENTS

- An active flight plan

### FEATURE LIMITATIONS

- Function not available when Direct-to is active.
- Graphical editing of the active leg cancels the parallel track function
- Offset range: 1 nm to 99 nm
- Large offset values combined with certain leg types (e.g., approach) or leg geometries (i.e., changes in track  $>120^\circ$ ) do not support parallel track

TRACK	COLOR
Offset	Magenta
Original	Gray

Once activated, a new track line appears to the left or right of the original course line at the specified distance. The aircraft navigates to the offset track with external CDI/HSI guidance now driven from the parallel track.



A graphical depiction overlays on the map.



Corresponding fix symbols on the flight plan indicate when the active leg is on a parallel track.

Active route identifiers also appear on the **GPS NAV Status** bar.



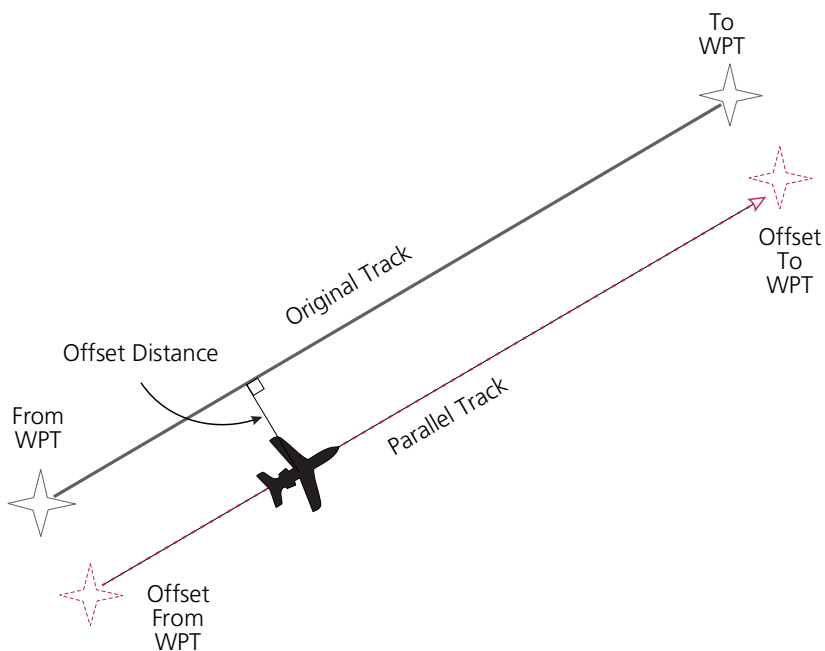

## ACTIVATE A PARALLEL TRACK



1. Tap **Menu** > **Parallel Track**.
2. Tap **Offset** and specify a distance between 1 nm and 99 nm.
3. Tap **Direction** and select left of track or right of track.
4. Tap **Activate**.

To deactivate parallel track, tap **Menu** > **Remove PTK**.

# Invert Flight Plan

Reverse the active flight plan and use it for navigation guidance back to your original departure point. Inverting the flight plan does not affect the original version stored in the catalog.

Be aware that inverting a flight plan removes all ATKs.

## INVERT THE ACTIVE FLIGHT PLAN

Tap **Menu** > **Invert**.

# Edit Data Fields

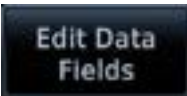

This function allows you to change the data type for any flight plan column. By default, flight plan displays:

- ALT • DTK • DIS

DATA FIELD SELECTIONS	
ALT	Altitude Constraint
CUM	Cumulative Distance
DIS	Distance
DTK	Desired Track
ESA	En Route Safe Altitude
ETA	Est. Time of Arrival
ETE	Est. Time En Route

Selections are identical for each data field.

### GTN 750Xi SERIES

Data field columns are arranged in numerical order (1 - 3).



## CHANGE DATA FIELD TYPE

1. Tap **Menu** > **Edit Data Fields**.
2. Tap any column/field and select a data type.

To restore data fields to their default settings, tap **Restore Defaults**.

# Flight Plan Catalog



Create, activate, edit, copy, and delete flight plans within the catalog.

## FEATURE LIMITATIONS

- Stores up to 99 flight plans with a maximum of 100 waypoints each



Each catalog entry includes the identifiers of the departure and destination waypoints. These comprise the route identifier.

## GTN 750Xi SERIES



In addition to the route identifier, these units display the route distance and en route safe altitude.

## Catalog Route Options

### Route Options

- Activate
- Invert & Activate
- Preview
- Edit
- Copy
- Delete

Selecting a flight plan opens a menu. Changes to the active flight plan take effect immediately.

- Activate the selected flight plan (replacing the active flight plan)
- Reverse and activate the selected flight plan
- Preview a selected flight plan
- Make changes to a flight plan
- Copy the flight plan and modify it to create a similar one
- Remove individual or multiple flight plans

### ACTIVATE

Activating a stored flight plan overwrites the active flight plan.

### INVERT & ACTIVATE

Reverse and activate the selected flight plan for guidance back to your original departure point. The inverted flight plan is a copy. Changes do not affect the original flight plan, which remains stored in the catalog.

*Remember: Inverting a flight plan removes all ATKs.*

### PREVIEW



View the flight plan route as it will appear on Map and on the Active Flight Plan app.

Options include Store, Activate

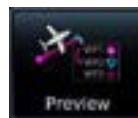

### EDIT

Modify the selected flight plan on the Edit Catalog Flight Plan page.

### COPY

Create a copy of the selected flight plan. A copy may be used as a starting point for creating a similar flight plan. Select the copy and tap Edit to make modifications.

### DELETE A FLIGHT PLAN

Deleting the active flight plan does not delete the stored flight plan in the catalog.

#### From the FPL menu:

1. Tap **Menu > Delete**.
2. Confirm the request.

#### From the catalog:

1. Select a flight plan.
2. Tap **Delete**.
3. Confirm the request to delete all waypoints.

### DELETE ALL CATALOGED FLIGHT PLANS

To remove all flight plans from the catalog:

1. Open the catalog.
2. Tap **Menu > Delete All**.
3. Confirm the request to clear the catalog.
4. Tap **Delete Pending**.
5. Confirm the request to remove all flight plans pending preview.

## Flight Plan Waypoint Options

### Options Menu

- Activate Leg
- Insert Before
- Insert After
- Along Track
- Hold at Waypoint
- Load Procedure
- Load SAR
- Waypoint Info
- Load Airway
- Remove

Selecting a waypoint identifier opens a menu. Changes to the active flight plan take effect immediately.

- Change the active leg
- Insert a new waypoint into a flight plan
- Add a temporary route fix (ATK)
- Add a holding pattern to an existing waypoint
- Add an airway or procedure
- Add a search and rescue pattern
- View information about a waypoint
- Remove a selected waypoint

<b>Activate Leg</b>	Designate any TO waypoint as the active flight plan leg. Requires an active catalog flight plan.
<b>Insert Before</b>	Insert a new waypoint before the selected waypoint.
<b>Insert After</b>	Insert a new waypoint after the selected waypoint.
<b>Along Track</b>	Specify an along track offset value before or after the selected waypoint.
<b>Hold at Waypoint</b>	Create a user-defined hold at the selected waypoint. Specify hold parameters and preview holding patterns from a dedicated menu page.
<b>Load Procedure</b>	Open the Procedures app to specify a departure, arrival, or approach for loading. Available controls are dependent upon the relative position of the aircraft to the active flight plan. Options may include: <ul style="list-style-type: none"> <li>• Activate Approach</li> <li>• Vectors to Final</li> <li>• Activate Missed Approach</li> </ul>
<b>Load Airway</b>	Assign an airway and exit waypoint to the selected entry waypoint (e.g., intersection, VOR).
<b>Load SAR</b>	Open the Search and Rescue function to create and add an SAR pattern after the selected waypoint.
<b>Waypoint Info</b>	Open the dedicated information page for the selected waypoint.
<b>Remove</b>	Remove the selected waypoint or hold from the active flight plan.

You may also set a direct course to any existing waypoint in the active flight plan. Select an identifier and tap the **Direct To** key. Details about Direct To features are provided in the respective section.

# Import a Flight Plan



## NOTE

*Flight plan format on GTN differs from that used by GNS 400W/500W Series navigators.*

### FEATURE LIMITATIONS

*Flight plans over 99 waypoints in length are truncated. As a result, the last waypoint in the imported flight plan may not be the destination airport.*

## Import Options

You can import flight plans wirelessly from Garmin Pilot or from an SD card. Once imported, they may be previewed and then stored in the catalog or activated.

### IMPORT USING CONNEXT

*On your portable device:* Select the option to transfer the flight plan(s) to GTN.

*On GTN:* The **MSG** key flashes, alerting you that a new message is active.

1. Tap **MSG** and read the “Flight Plan Import” message.
2. Tap **New FPL** to preview the flight plan.
  - For a single flight plan, the preview page opens.
  - For multiple flight plans, the catalog opens.

Selecting a cataloged flight plan that is “Pending Preview” opens a slide-out menu.

To view the flight plan, tap **Preview**. To delete it without viewing, tap **Delete**.

### IMPORT FROM A DATACARD

*On your personal computer:* Create the flight plan(s) using compatible flight planning software. Save the file(s) to an SD card.

*On GTN:* After installing the datacard and applying power to the unit, go to the Active Flight Plan page and open the catalog.

#### From the Flight Plan Catalog:

1. Tap **Menu** > Import.
2. Select a flight plan from the list of datacard files.
3. Tap Store or **Activate**.

## Potential Import Errors

Pop-up messages alert you when an import problem occurs.

Tapping **Next** advances through multiple error messages. Tapping **OK** acknowledges the error and closes the popup.

The following errors can prevent GTN from successfully importing your flight plans.

### Full catalog.

Delete any unnecessary catalog entries and try again.

### Flight plan contains errors.

Any airways, procedures, or non-user waypoints not found in the database will result in an error. GTN replaces these with locked (*lockd*) waypoints, which must be resolved prior to activation.

### Flight plan exceeds the waypoint limit.

GTN truncates the flight plan to the correct length; however, you should be aware that waypoints are missing from the end of the flight plan, including the destination waypoint.

## Along Track Offsets

An along track (ATK) represents a temporary lateral position (or checkpoint) relative to an existing waypoint in the flight plan. Offset distance values range between 1 nm and 200 nm, and may be specified in 1 nm increments.

Unlike database waypoints, ATKs indicate a temporary route fix in the flight plan.

Once created, their position remains fixed until deleted by the pilot. Subsequent changes to the flight plan do not update the ATK's position.

Flight plan allows multiple entries.

ATKs appear in flight plan route depictions on Active Flight Plan and Map.



Inserting an ATK before the selected waypoint results in a negative offset value. Inserting it after results in a positive value.

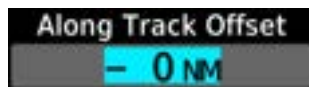

### CREATE AN ATK

#### From the active flight plan:

1. Select a reference waypoint.
2. Tap **Along Track** and specify an offset distance.
3. Choose **Before** or **After**.
4. Tap **Enter**.

### CREATE AN ATK FOR AN ALTITUDE CONSTRAINT

#### From the active flight plan:

1. Select an altitude constraint.
2. Tap **Along Track** and specify an offset distance.
3. Choose **Before** or **After**.
4. Tap **Enter** > **Save**.

### ATK OFFSET MODIFICATIONS

Once set, offset distances are not editable.

To adjust an existing offset value:

1. Select the ATK from the flight plan.
2. Tap **Delete**.
3. Create a new ATK with the correct offset distance.

# Flight Plan Map Overlays

## Leg Status Indications

LEG STATUS	COLOR
Active	Magenta
Next & Future	White
Past or Inactive	Gray

Active, next, and previous flight plan legs overlay on Map and are display only.

*Status leg indications.*



## Along Track Offset Indications



Map indications include a dedicated icon and an identifier label. Identifier labels on Map denote the adjacent waypoint's ID and offset distance from the specified ATK.

Selecting an ATK displays its bearing and distance in the info banner.

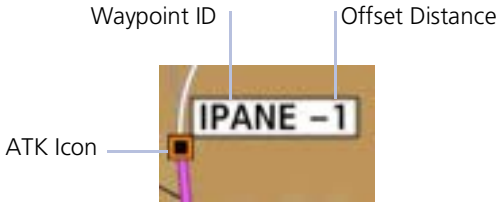

**Abbreviated Map Label**

Unlike waypoints, ATKs indicate a temporary route fix in the flight plan.



## Altitude Constraint Labels

Altitude constraint data display as text labels on the Map. Units are typically feet or meters depending on current altitude setting in the System Units. They display as flight level altitudes if specified as such on the navigator.

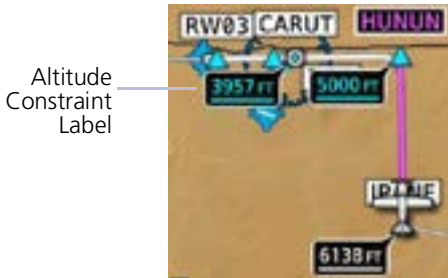

If excessive labels are cluttering the map, this feature may be turned off.



## User Airport Icon



A dedicated icon indicates user created airport waypoints. User airport indications display on Active Flight Plan and Map.

When selected, the user identifier annunciates in the info banner.



Identifier Type Icon



Selected User Airport

User Identifier

# CDI



The CDI function selects data sent from the GPS or VLOC receiver to the external CDI (or HSI).

Tapping the **CDI** key toggles between navigation sources. If configured, this key resides in the control bar.



## NOTE

*Information provided by the onscreen CDI is based on GPS data. Do not use for primary navigation.*

### FEATURE LIMITATIONS

- GPS phase of flight annunciations (e.g., LPV, ENR) are not applicable to the external CDI/HSI when VLOC is active.
- Availability dependent upon configuration

For approaches not approved for GPS, select the VLOC receiver for display on the external CDI/HSI.

The selected source annunciates at the bottom of the display.

#### GPS Receiver



#### VLOC Receiver



### If the unit is not configured for a CDI key:

Tapping **Activate GPS Missed Approach** only resumes automatic waypoint sequencing. To switch to GPS navigation, use your external source selection method (this is typical of an EFIS system).

### GTN 650Xi SERIES



CDI scales display on the Default Navigation page (Home > **Default NAV**).

### GTN 750Xi SERIES

CDI scales appear at the bottom of the map display. This indicator is not visible during pan mode.

# GPS Nav Status Bar

### FEATURE REQUIREMENTS

- Active flight plan for from-to-next route information

This selectable indicator bar shows from-to-next route information when an active flight plan exists. Indications change based on active leg status.

Tapping this bar provides direct access to the active flight plan.

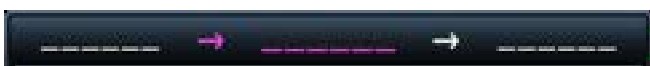

### No Flight Plan Exists

Underscores denote the absence of an active leg.



### Active Route Display

Fields change to show active route identifiers and leg types. Includes:

- From, to, and next waypoints
- Leg and waypoint types
- Identifier

## GTN 650Xi SERIES



This indicator is a feature of the Default Navigation page (Home > **Default NAV**).

## GTN 750Xi SERIES



GPS Nav status indications appear at the bottom of the map display as part of the CDI. This bar is not visible during pan mode.



# Direct To



Set a course to any waypoint using Direct To.

## FEATURE LIMITATIONS

- Not all flight plan entries are selectable using Direct To (e.g., holds, course reversals)
- Available search and rescue patterns are dependent upon configuration.

## Direct To Basics



**Direct To Window**

Pushing this bezel key opens a slide-out window. Search tabs provide three different methods of waypoint selection.

- *Waypoint*: Enter a specific waypoint or find one using additional search tabs.
- *FPL*: Select a waypoint from the active flight plan.
- *NRST APT*: Select a nearby airport.

Underscores denote the absence of a loaded course, hold, or search and rescue pattern.

### Direct To is useful for quickly navigating to:

- New waypoints
- An existing waypoint in the active flight plan
- Nearby airports
- Map waypoints
- An off-route course
- User-defined holds

When navigating to a single waypoint (e.g., a nearby airport), the Direct To function provides a quicker alternative to using the active flight plan.

## Direct To Search Tabs

### WAYPOINT



Similar to an information page, but with course and hold options. This tab is active by default.

Selecting an identifier automatically displays the following information about the waypoint.

- Identifier and type icon
- Applicable city, state, country and/or region (e.g., “NW USA”)
- Distance and bearing from current aircraft position
- Waypoint coordinates

**Select Waypoint/  
Identifier Key**

Type an identifier or access multiple search tabs using the Find function.

**Course To**

Specify the course angle for the navigation path.

**Hold**

Create, load, and activate a user-defined hold.

**SAR**

Specify a search and rescue pattern.

## FPL & NRST APT

FPL and NRST APT tabs provide a list of selectable identifiers. These tabs have a uniform layout.



Lists all waypoints contained in the active flight plan.



Lists up to 25 waypoints within a 200 nm radius. The closest airport appears at the top of the list.

## Direct To Activation

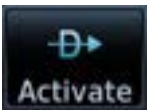

Activating a direct course establishes a point-to-point line from the aircraft's present position to the selected destination.

The unit provides course guidance until you remove the direct-to waypoint, or replace it with a new direct course or flight plan.



For convenience, you may activate a direct course using the inner control knob.

After selecting a waypoint, push the knob to activate the direct course.

The window closes and Map opens to show the active leg.

## ACTIVE FIX INDICATIONS



Upon activation, Map automatically opens to show a graphical representation of the active direct-to leg.



### GPS Nav Status Bar

GPS navigation status changes to show the active direct-to fix. Indication includes the corresponding fix symbol and waypoint identifier.



### Map User Field

If configured, a user field shows the active waypoint identifier on Map.



### Active Flight Plan Indication

Fix symbol and identifier display in the upper-left corner of the flight plan.

## Navigating Direct To

While most direct-to operations follow the same basic steps, the method for selecting a waypoint may vary.

### DIRECT TO A NEW WAYPOINT

1. Tap **Direct To**.
2. Select a waypoint identifier.
3. Tap **Course** and specify the course heading (if a specific course is necessary).
4. Activate the selection.

### DIRECT TO A FLIGHT PLAN WAYPOINT

#### Flight Plan Waypoints

If a flight plan exists, waypoint sequencing resumes once you reach the direct-to waypoint. If the waypoint is not in the flight plan, the flight plan is no longer active but remains available.

Direct To options are not available for all flight plan entries. Some entries include holds and course reversals which are not selectable using Direct To.

1. Tap **Direct To**.
2. Select **FPL** tab.
3. Select a flight plan leg.
4. Activate the selection.

### DIRECT TO THE NEAREST AIRPORT

1. Tap **Direct To**.
2. Select **NRST APT** tab.
3. Select an airport.
4. Activate the selection.

### DIRECT TO A MAP WAYPOINT

#### MAPWPT

For map locations without an existing name, Direct To assigns the "MAPWPT" identifier. Bearing, distance, and map coordinates display on the Waypoint tab.

Apply a direct course to any location on the map.

1. Tap a location on Map.
2. Tap **Direct To**.
3. Activate the selection.

You can modify direct-to routes on Map using the **Graphical Edit** function the same as you would a flight plan.

### DIRECT TO AN OFF-ROUTE COURSE

You may activate an off-route course using any of the described direct-to methods.

Activating an off-route direct course automatically deactivates the current leg of the active flight plan.

#### Direct To & Procedure Fixes

Approach guidance is not available for procedure fixes. An example would be activating a direct course to a waypoint between the final approach fix and missed approach point. Upon arriving at the waypoint, approach guidance does not become active.

### Removing a Direct Course



To cancel the current direct course, tap **Remove**.

Removing a direct course:

- Reactivates the original active flight plan
- Assigns the leg nearest to the aircraft's position as the active leg
- Resumes waypoint sequencing

If no active flight plan exists, the aircraft continues on its current heading without any navigation guidance.

# User Holds



Define a holding pattern for any direct-to waypoint. User holds suspend automatic waypoint sequencing until they expire or are removed.

Tapping **Hold** displays available hold options.

## Hold at Waypoint Options



The controls on this page allow you to:

- Specify course, direction, and turn.
- Set leg length according to distance or time.
- Set up an Expect Further Clearance reminder.
- Preview how the defined holding pattern will appear on Map.
- Load the specified hold for activation.

<b>Course</b>	Specify the course angle.
<b>Direction</b>	Select between Inbound or Outbound.
<b>Turn</b>	Select between Left Turn or Right Turn.
<b>Leg Type</b>	Select Time or Distance.
<b>Leg Time</b>	Specify the leg time in minutes and seconds (MM:SS).
<b>Leg Distance</b>	Specify the leg distance.
<b>Expect Further Clearance (EFC)</b>	Specify a time for the Expect Further Clearance reminder.
<b>Load Hold</b>	Accept the specified hold parameters and return to the Direct To window.
<b>Preview</b>	View the defined holding pattern as it will appear on Map. Available on GTN 650Xi Series units only.

### HOLD PREVIEW



A window displays the defined holding pattern on a 2-D map of the surrounding area (includes SafeTaxi depictions).

#### GTN 650Xi SERIES

Tapping **Preview** displays the hold on a dedicated map page. You may view and load the hold, or return to the setup menu for more options.



### CREATE & ACTIVATE A HOLD



From the Waypoint tab:

1. Tap **Hold**.
2. Specify hold parameters.
3. Tap **Load Hold**.
4. Activate the selection: Tap **Hold Activate** or push the inner control knob.

# Search and Rescue Patterns



Create a search and rescue pattern for any direct-to waypoint or off-route course.

Tapping **SAR** displays options for defining a search and rescue pattern for the direct-to waypoint.

## SAR Pattern Options



The controls on this page allow you to:

- Select a pattern type.
- Specify an initial track angle and spacing distance.
- Select the turn direction.
- Specify the number of legs.
- Load the specified pattern for activation.

<b>SAR Pattern</b>	Select a pattern from the list of available types.
<b>Initial Track</b>	Specify an initial track angle.
<b>Initial Turn Direction</b>	Select between Left or Right.
<b>Leg Length</b>	Specify the leg length.
<b>Track Spacing</b>	Specify the track spacing distance.
<b>Leg Count</b>	Specify the number of legs.
<b>Load Pattern</b>	Accept the specified pattern and return to the Direct To window.
<b>Preview</b>	View the defined SAR pattern as it will appear on Map. Available on GTN 650Xi Series units only.

When you create a search and rescue pattern as part of an off-route direct course, the function inserts the associated waypoints at the end of the en route portion of the active flight plan.

## SAR PATTERN PREVIEW

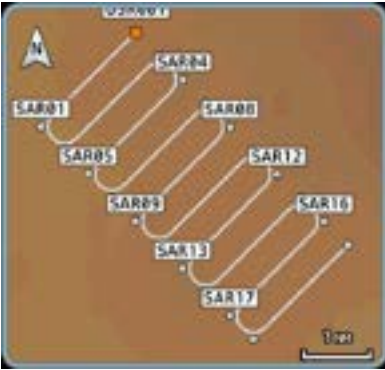

A window displays the defined pattern on a 2-D map of the surrounding area (includes SafeTaxi depictions).

### GTN 650Xi SERIES

Tapping **Preview** displays the pattern on a dedicated map page. You may view and load the pattern, or return to the setup menu for more options.



## SAR PATTERN TYPES



Upon loading, the SAR key label changes to reflect the selected pattern type. Depending on configuration, not all pattern types may be available.



Parallel Track



Sector Search



Expanding Square



Orbit

## CREATE & ACTIVATE A SEARCH AND RESCUE PATTERN



From the Waypoint tab:

1. Tap **SAR** > **SAR Pattern**, and select a pattern type.
2. Review the displayed pattern information.
3. Tap **Load Pattern**.
4. Activate the selection: Tap **SAR Activate** or push the inner control knob.

# Waypoints

There are two types of waypoints: database and user



Database waypoints (i.e., waypoints contained in the navigation database) are organized into the following groups.

- Airport (APT)
- Intersection (INT)
- Very High Frequency Omni-directional Range (VOR)
- Visual Reporting Point (VRP)
- Non-Directional Beacon (NDB)

The Airport page is a great place to start when performing an approach brief, checking weather, or considering a diversion.



You also have the ability to define any point in space and store it. Unlike database waypoints, these “user” waypoints are editable.

# Waypoint Information



Dedicated information pages provide waypoint search functions and details not available on Map.

**FEATURE REQUIREMENTS**

- FIS-B (viewing NOTAMs)
- Navigation database containing VRP waypoint data

**FEATURE LIMITATIONS**

- FIS-B transmits distant and FDC NOTAMs within 100 nm of radio station position

Intersection, VOR, VRP, and NDB information pages have a uniform layout.



**VOR Information Page**

1	Waypoint Identifier Key	6	Map Preview
2	Location Information	7	Station Declination
3	Class Information	8	Nearest NAVAID information
4	Frequency Selection Key	9	Waypoint coordinates
5	Waypoint Map Symbol	10	Waypoint Distance & Bearing

## Common Page Features

### Data Fields

- Distance and bearing from current aircraft position
- Latitude and longitude
- Applicable city, state, country and/or region (e.g., "NW USA")
- Identifier and type icon

### Waypoint Identifier

This key provides access to multiple waypoint search options. These include the **FastFind** feature and multiple search tabs.

## MAP PREVIEW WINDOW

A 2-D map of the surrounding area (includes SafeTaxi airport depictions).



### GTN 650Xi SERIES

Tapping **Preview** displays the waypoint location on a dedicated map page.



As you approach an airport, use the map preview function to orient yourself for such things as pattern entry or runway alignment.

# Waypoint Specific Page Features

The following features are unique to the corresponding waypoint.



### Airport

*Selectable tabs:*

**Info:** Airport location, elevation, time zone, and fuel availability.

**Procedures:** Available approach procedures.

**Runways:** Identifiers, size, surface type, and traffic pattern direction.



Tapping **Runway** opens a list of available runways.

**Frequencies:** Available communication and localizer frequencies. The “c” symbol denotes frequencies that function as the CTAF.

View additional frequency information by tapping

**More Information**, if available.

**WX Data:** Applicable METARs, city forecasts, and TAF weather information.

**NOTAMs:** Applicable distant and FDC NOTAMs.

**VRPs:** Nearest VRPs.

---



### Intersection

*Data fields:*

- Nearest VOR (identifier, type icon, bearing, and distance)
- 

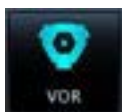

### Very High Frequency Omni-directional Range

**Frequency:** Loads the indicated value as the COM or NAV frequency.

*Data fields:*

- Frequency
  - Nearest airport (identifier, type icon, bearing, and distance)
  - Station declination
  - VOR class
- 



### Visual Reporting Point

*Data fields:*

- Nearest VRP (identifier, type icon, bearing, and distance)



### Non-Directional Beacon

*Data fields:*

- Frequency
- Nearest airport (identifier, type icon, bearing, and distance)
- Marker description



### User Waypoint

*Selectable functions:*

**Edit:** Opens the Create User Waypoint page for editing purposes.

**View List:** Displays a list of all user waypoint identifiers.

**Delete:** Removes the selected user waypoint from the list.

**Delete All:** Removes all user waypoints from the list.

All deletions require user confirmation.

User waypoints in the active flight plan cannot be edited or deleted.

*Data fields:*

- Reference position or nearest waypoint (identifier, type icon, radial, and distance), whichever is applicable
- Number of waypoints used out of 1,000

The User WPT page is the only page that allows you to view an entire list of all user waypoints created and saved in the database.

# Waypoint Selection

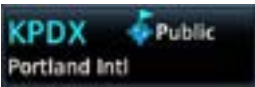

The **Waypoint Identifier** key provides access to different waypoint search options.

Enter a specific identifier or select one from the available search tabs.

## Waypoint Autofill

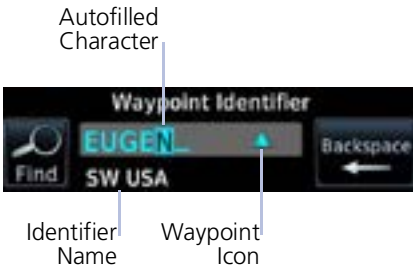

As you type the identifier name, alphanumeric characters autofill based on the first alphabetical match in the navigation database.

Autofill characters are cyan and display from the cursor position to the right of the field.

Matching waypoint entries typically change with the addition of each typed character.

“No matches found” and “Duplicates found” announce when applicable.

## FastFind Predictive Waypoint Entry



FastFind predicts a waypoint based on the characters you select. As you type, the key label changes to reflect the identifier of the nearest matching entry.

Tap to select the predicted waypoint and open the corresponding information page.

Because it relies on your GPS position, FastFind can make predictions based on a single key press.

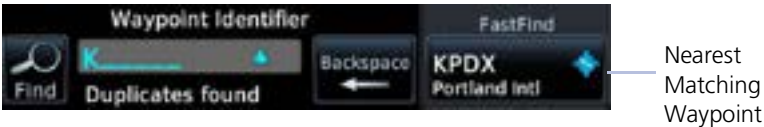

Nearest  
Matching  
Waypoint

If no matches are found, "No suggestion" annunciates and the key is not selectable.

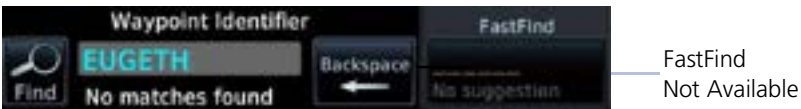

FastFind  
Not Available

### FastFind & Flight Plan

For convenience, use FastFind when creating your flight plan. GTN will search for waypoints closest to the current GPS position.

- If inserting a waypoint in the middle of the flight plan, GTN searches for waypoints between the next and previous waypoints.
- If adding a waypoint to the end, GTN searches for waypoints closest to the last waypoint in the flight plan.

FastFind is a convenient shortcut when you are adding waypoints to a flight plan or trying to find a waypoint in a hurry.

## Search Tabs



The **Find** key provides access to multiple search tabs.



Each tab displays a list of selectable identifiers based on specific criteria. These include:

- Recent
- Nearest
- Flight Plan
- User
- Search Name
- Search City

### Waypoint Search Tabs

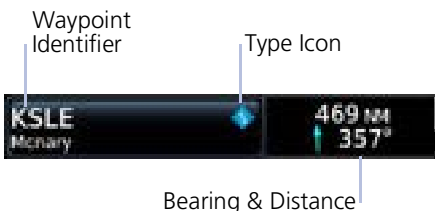

Each entry includes general information about the associated waypoint.

### RECENT

Lists up to 20 of the most recently viewed waypoints.

### NEAREST

Lists up to 25 waypoints within a 200 nm radius.



Tap **Filter** and select from the available filter options. Only waypoints belonging to the selected class appear in the list.

To list all classes, select **All**.

## FLIGHT PLAN

Lists all waypoints contained in the active flight plan.

## USER

Lists up to 1,000 user-defined waypoints.

## SEARCH BY NAME/CITY



### Search By Name

Lists all airports, NDBs, and VORs associated with the specified facility name.

Tap **Search Facility Name** to begin search.



### Search By City

Lists all airports, NDBs, and VORs found in proximity of the city.

Tap **Search City Name** to begin search.

# Create User Waypoints



Create and store up to 1,000 user defined waypoints.

## FEATURE LIMITATIONS

- Duplicate user waypoint identifiers are not allowed
- Names may be up to six characters in length
- Comment may be up to 25 characters
- Maximum waypoint limit: 1,000

## WHERE TO FIND IT

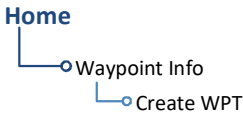

You may access this page from the following applications:

- Waypoint Info
- Map

## MAP POINTER/CREATE WAYPOINT KEY



Tapping any location on Map that is not an existing waypoint displays this page access key.

## USER WAYPOINT IDENTIFIER

Assign a unique identifier or keep the unit generated identifier. If an identifier is already in use, the three digit number increments automatically upon opening the page.



### User Waypoint

By default, the identifier format is "USR" followed by a sequential three digit number.



### User Airport

Identifier format is "A" followed by a sequential three digit number.

User waypoints are helpful when ATC requests that you fly one radial to intercept another. While the point is often defined by an intersection in the navigation database, this is not always the case. The Create User Waypoint function allows you to define the new intersection and insert it into the flight plan in advance, as opposed to using the NAV radio to tune each VOR and specify the radials to fly inbound and outbound.

## Define Waypoint Criteria

### Create Waypoint Options

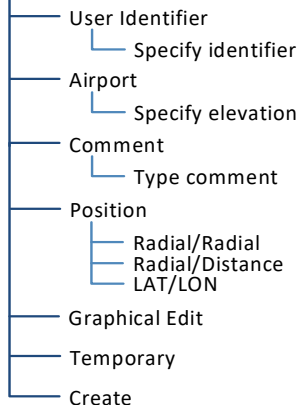

Active user waypoints already existing in a flight plan are not editable.

When creating a user waypoint, you have the option to:

- Assign a unique identifier
- Set the waypoint as temporary
- Enter a comment
- Set waypoint position
- Specify elevation (user airports only)
- Edit the waypoint graphically

<b>User Identifier</b>	Assign a unique identifier.
<b>Airport</b>	Label the user waypoint as a user airport
<b>Comment</b>	Type a comment regarding the new waypoint.
<b>Position</b>	Set the waypoint position.
<b>Graphical Edit</b>	Open a preview map for graphical editing purposes. User waypoint icon remains stationary as you move the surrounding map to the new location.
<b>Temporary</b>	Assign the waypoint a temporary status. Identifier remains available until the next unit power cycle.
<b>Elevation</b>	Specify the elevation of the user airport. Available only when the Airport key is active.
<b>Create</b>	Add the new identifier to the used waypoints list. The associated information page opens automatically for viewing and editing purposes.

## COMMENT FORMAT

Default comments display in a specific format for each reference type.

### LAT/LON



<LAT> <LON>

### Radial/Distance



<Waypoint><Radial> / <Distance>

### Radial/Radial



<Waypoint 1><Radial 1> / <Waypoint 2><Radial 2>

## POSITION TYPE

Set the waypoint position type using one of the following options.

### Radial/Radial

Specify a waypoint and radial for each of the two reference points.

### Radial/Distance

Specify the reference waypoint, radial, and distance.

### LAT/LON

Specify the point's latitude and longitude.

## MARK WAYPOINTS

Installations equipped with an external Mark on Target (MOT) switch allow immediate user waypoint creation by marking the point in space at which the switch is activated.

These waypoints contain a unique identifier with a sequential three digit number ("MOT###") that increments with every push of the MOT switch. If the number exceeds 999, the counter resets and begins to overwrite identifiers at the beginning of the list.

Upon marking a target with an MOT switch, the waypoint may be obscured by the ownship and not readily visible. In such cases, you may verify waypoint creation by changing the map zoom level or viewing the User Waypoints page.

# Create a User Waypoint

## OPEN CREATE USER WAYPOINT PAGE

### From Map:

Home > **Map** > select any non-waypoint location > **Map Pointer/Create Waypoint**

### From Waypoint Info:

Home > **Waypoint Info** > **Create Waypoint**

## ASSIGN POSITION VALUES

From the Create User Waypoint page:

1. Tap **Position** > **LAT/LON** > **Latitude/Longitude** > specify the waypoint's coordinates > **Create**.

### OR

1. Hold and drag the basemap until the user waypoint icon appears over the desired location.
2. Tap **Create**.

## MODIFY DEFAULT SETTINGS

Modify default settings as necessary.

- *Create a custom identifier:* Tap **User Identifier** and enter a new one.
- *Add a comment:* Tap **Comment** and enter the appropriate text.
- *If the waypoint is an airport:* Tap **Airport** > **Elevation**, then specify the number of feet.
- *If the waypoint is for temporary use:* Tap **Temporary**.

Once all modifications are complete, tap **Create**.

# Edit an Existing User Waypoint

## FEATURE LIMITATIONS

- *User waypoints that are part of a flight plan or direct course are not editable*

## ACCESS USER WAYPOINT EDIT OPTIONS

You can access the edit function multiple ways.

### From the dedicated information page:

Home > **Waypoint Info** > **User WPT** > specify an identifier, or tap **View List** and select an identifier from the used waypoints list > **Edit**

### From the Nearest page:

Home > **Nearest** > **User WPT** > select an identifier from the list (e.g., USR001) > **Edit**

### From the Active FPL page:

Home > **Flight Plan** > select the identifier from the flight plan > **Waypoint Info** > **Edit**

## MODIFY POSITION VALUES

From the Edit WPT page, you can modify a user waypoint's position one of two ways:

1. Tap **Position** > **LAT/LON** > **Latitude/Longitude** > specify the waypoint's coordinates > **Save**.

### OR

1. Hold and drag the basemap until the user waypoint icon appears over the desired location.
2. Tap **Save**.

# Delete User Waypoints

### FEATURE LIMITATIONS

- *User waypoints that are part of a flight plan or direct course cannot be deleted*

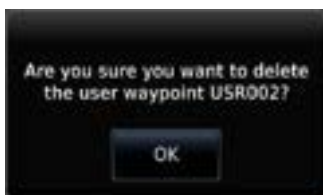

You can delete a user waypoint from its information page:

1. Select the user waypoint, then tap **Delete**.
2. Confirm the request.

## DELETE ALL USER WAYPOINTS

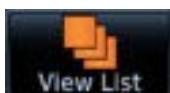

From the User Waypoints list, you can delete all user waypoints or filter the list and delete only a certain type.

This list is accessible from the information page.



**User Waypoints List**

1. Tap **View List > Menu**.
2. Tap **Filter** and select the type of user waypoints you wish to delete. Options include All, Basic, and Airport.
3. Tap **Delete All**.

# Import User Waypoints



The **Import Waypoints** key appears when the unit detects a user waypoint on the datacard.

## FUNCTIONAL LIMITATIONS

- User waypoint file size must not exceed 8 GB



## NOTE

*The import function overwrites any existing user waypoint of the same name.*

## CREATE USER WAYPOINT FILE

You may create a list of new user waypoints using any spreadsheet program. Read "User Waypoint File Considerations" for limitations and formatting specifications. Organize columns as follows.

A	B	C	D
Waypoint Name	Comment	Latitude	Longitude

	A	B	C	D
1	MTHOOD	MT HOOD PEAK	45.3723	-121.69783
2	CRTRLK	CRATER LAKE	42.94683	-122.11083
3	EIFFEL	EIFFEL TOWER	48.858151	2.294384
4	OCEAN		32.68735672	-51.45543634

## User Waypoint File

### User Waypoint File Considerations

- Limit one waypoint per row
- Names may be up to six characters in length
- Comments may be up to 25 characters
- All letters must be upper case
- Latitude: two digits left of decimal; up to nine digits right of decimal
- Longitude: three digits left of decimal; up to eight digits right of decimal
- (-) indicates southern latitudes (column C) or western longitudes
- Express latitude and longitude coordinates in decimal degrees

Save the file in the .csv format under the name "user.csv." Change the file extension to ".wpt" before copying the file to a blank SD card.

### IMPORT USER WAYPOINTS

1. Ensure that the unit power is off.
2. Insert datacard containing user waypoints.
3. Power on unit.
4. From the Home page, tap **Waypoint Info > Import Waypoints**.
5. Acknowledge the pop-up message.

The import function executes in the background. Once the import is complete, an advisory message informs: "User waypoints were imported successfully."

The waypoints are now available for use. You may power down the unit and remove the SD card.

If an imported waypoint is within 0.0001 degree (latitude and longitude) of an existing user waypoint, the existing waypoint and name will remain in use.

# Nearest



View a list of the nearest waypoints, frequencies, or facilities within 200 nm of the aircraft's position.

## From the Home page:

1. Tap **Nearest** and then select a waypoint or frequency icon.
2. Scroll through the list of entries.

Information varies according to the selected waypoint or frequency type. Nearest waypoints provide an identifier key for accessing the associated information page.



### Nearest Airport

- identifier • symbol • distance • bearing • approach type
- length of longest runway



### Nearest Intersection

- identifier • symbol • distance • bearing



### Nearest Very High Frequency Omni-directional Range

- identifier • symbol • distance • bearing • frequency



### Nearest Visual Reporting Point

- identifier • symbol • distance • bearing



### Nearest Non-Directional Beacon

- identifier • symbol • distance • bearing • frequency



### Nearest User Waypoint

- identifier • symbol • distance • bearing



### Nearest Airspace

- identifier • symbol • proximity



### Nearest Air Route Traffic Control Center

- facility name • distance • bearing • frequency



### Nearest Flight Service Station

- facility name • distance • bearing • frequency
- ("RX" denotes receive-only frequencies)



### Nearest Weather Frequency

- facility name • distance • bearing
- frequency of nearest ATIS, ASOS, AWOS, and VOR

## ENTRY LIMITS

NEAREST LIST	ENTRY LIMIT
ARTCC, FSS	05
Airspace	20
Airport, Intersection, VOR, VRP, NDB, User, Weather FREQ	25

The number of entries displayed varies according to item type.

Entries are ordered from closest to farthest.

## UPDATE INTERVALS

With the exception of nearest airspace, all lists update every 30 seconds. The nearest airspace list updates once per second.

## MULTIPLE FREQUENCIES



This key displays when more than one frequency is available at the indicated range.

Applicable to functions displaying information only (ARTCC, FSS, and WX FREQ).

# Procedures



Lateral and vertical guidance is available for visual and GPS/RNAV approaches. The published instrument approach procedures allow precision and non-precision approaches to airports. These are directly accessible via the Procedures app.

## FEATURE REQUIREMENTS

- *Baro-corrected altitude source (automatic sequencing of altitude leg types)*

*In the absence of baro-corrected altitude data, altitude leg types require manual sequencing.*

## FEATURE LIMITATIONS

- *Flight Plan allows only one of each procedure type to be loaded at a time; adding a new procedure overwrites any existing procedure of the same type*

## LOAD A PROCEDURE



Select a procedure type, then define the criteria for that procedure on the corresponding setup page.

By default, these keys display underscores.



Upon completion, the specified airport and procedure appear on the associated key.

When loading a procedure, always remember to check the runway, transition, and all waypoints.

## COMMON PAGE CONTROLS

All procedure pages provide the following setup controls.

**Airport:** Select an airport for the procedure.

**Transition:** Select a transition.

**Runway:** Select a runway for the selected airport.

**Preview:** View a 2-D map of the surrounding area (includes SafeTaxi airport depictions).

For page specific controls, refer to the appropriate procedure description.

# Flight Procedure Basics



## NOTE

*Advisory climb altitudes for SIDs may not match charted altitudes. Do not rely solely on advisory altitudes.*

- Always check the runway, transition, and waypoints for all procedures.
- Heading legs indicate in white as “HDG XXX°” on flight plans.
- The unit provides lateral and, when appropriate, vertical guidance for visual and GPS/RNAV approaches.
- Use Map as an aid to situational awareness during ILS, VOR, NDB, and non-precision localizer-based approaches. A magenta line depicts the active leg (or the portion of the approach currently in use).
- Always use the appropriate radio navigational aid for primary approach course guidance during non-GPS approaches.
- Check the annunciator bar for the current phase of flight.
- Many non-precision approaches have GPS overlays, improving accuracy so that approaches do not require overflying a VOR or NDB.
- The unit guides you through complex overlay approaches, automatically sequencing each leg up to the missed approach point.
- Fly approaches as published with the full transition using any published feeder route or initial approach fix, or with a vectors-to-final transition.
- While not required under TSO-C146e, an optional baro-corrected altitude source is recommended for automatic sequencing of altitude leg types.

## When adding procedures to a flight plan:

Always verify the transition waypoints between each phase are correct. If using Descent VNAV, verify that the altitudes for the selected procedure match the charted or ATC cleared altitudes and are appropriate for the airframe type.

Map complements your printed approach plates by improving situational awareness during the approach. It does not replace printed approach plates.

**Always fly an approach as it appears on the approach plate.**

## Roll Steering

When switching the CDI source from GPS to VLOC during ILS, VOR, NDB, and non-precision localizer-based approaches, roll steering terminates when approach mode is selected on the autopilot. It becomes available once you initiate the missed approach.

## TO/FROM LEGS ON CDI

### TO Legs

On these legs, the FROM/TO flag on the CDI indicates "TO" and the Distance field on the flight plan decreases as you navigate the leg.

Most legs are this type

### FROM Legs

On these legs, the FROM/TO flag on the CDI indicates "FROM" and the Distance field on the flight plan increases as you navigate the leg.

From legs are typically found on procedure turns and on some missed approach procedures.

## Localizer or VOR-based Approaches

GTN automatically switches the external CDI output from GPS to VLOC as you intercept the final approach course. When the ILS approach activates and the correct ILS frequency activates in the VLOC window, the GTN automatically switches to VLOC within 1.2 nm left or right of the final approach course. This switch can take place anywhere from 2.0 to 15.0 nm from the FAF.

*This illustration shows multiple locations along the approach path and the CDI selection that you can expect: GPS or VLOC. The shaded area depicts where the automatic switch from GPS to VLOC should occur.*

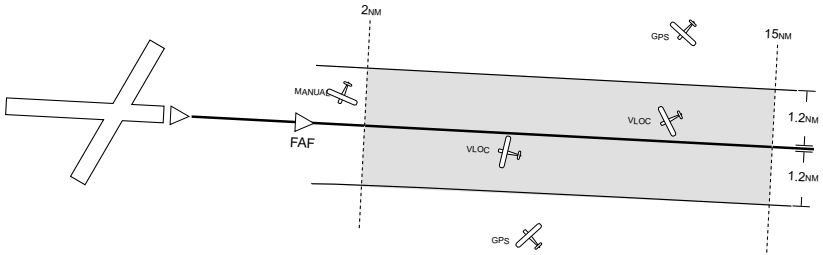

The automatic switch from GPS to VLOC is not immediate, but instead occurs gradually to prevent abrupt CDI changes when coupled to an autopilot. The CDI selection can also be changed manually by tapping **CDI**.

If you attempt to intercept the approach course at a distance less than 2.0 nm from the FAF, tap CDI to manually switch from GPS to VLOC.

## GPS Flight Phase Annunciations

Flight Phase  
(Caution)

Check the annunciator bar for current phase of flight.



Map complements your printed approach plates by improving situational awareness during the approach. It does not replace printed approach plates. **Always fly an approach as it appears on the approach plate.**

Under normal conditions, these annunciations are green. They turn yellow when cautionary conditions exist.

Phase of flight annunciations are a direct indication of the current CDI behavior for the selected navigation source.

Not all annunciations are available for every navigator.

ANNUNCIATION	FLIGHT PHASE
0.30 NM	<ul style="list-style-type: none"> <li>0.3 nm CDI scale</li> <li>Based on pilot selection</li> </ul>
1.00 NM	<ul style="list-style-type: none"> <li>1.0 nm CDI scale</li> <li>Based on pilot selection</li> </ul>
DPRT	<p><b>Departure</b></p> <ul style="list-style-type: none"> <li>Terminal level with departure procedure as the active navigation</li> <li>System using non-precision approach integrity</li> <li>CDI full-scale deflection: 0.30 nm</li> </ul>
DR	<p><b>Dead reckoning</b></p> <ul style="list-style-type: none"> <li>CDI not available</li> </ul>
ENR	<p><b>En route</b></p> <ul style="list-style-type: none"> <li>CDI full-scale deflection: 2.0 nm or current CDI scale selection, whichever is smaller</li> </ul>
LNAV	<p><b>Lateral Navigation Approach</b></p> <ul style="list-style-type: none"> <li>Fly to published LNAV minimums</li> </ul>
LNAV+V	<p><b>Lateral Navigation Approach with Advisory Vertical Guidance</b></p> <ul style="list-style-type: none"> <li>Fly to published LNAV minimums</li> </ul>
LVNAV	<p><b>Lateral and Vertical Navigation Approach</b></p> <ul style="list-style-type: none"> <li>Fly to published LNAV/VNAV minimums</li> </ul>

ANNUNCIATION	FLIGHT PHASE
LOW ALT	<p><b>Low Altitude</b></p> <ul style="list-style-type: none"> <li>• Aircraft’s estimated height is lower than the final approach waypoint height by approximately 50 meters</li> <li>• For LNAV+V, LNAV/VNAV, LP +V, or LPV approaches</li> <li>• Not active when terrain alerting functions are operational</li> </ul>
LP	<p><b>Localizer Performance Approach</b></p> <ul style="list-style-type: none"> <li>• Fly to published LP minimums</li> </ul>
LP +V	<p><b>Localizer Performance Approach with Advisory Vertical Guidance</b></p> <ul style="list-style-type: none"> <li>• Fly to published LP minimums</li> </ul>
LPV	<p><b>Localizer Performance with Vertical Guidance Approach</b></p> <ul style="list-style-type: none"> <li>• Fly to LPV minimums</li> </ul>
MAPR	<p><b>Missed Approach</b></p> <ul style="list-style-type: none"> <li>• System using missed approach integrity</li> <li>• CDI full-scale deflection: <math>\pm 0.30</math> nm</li> </ul>
OCN	<p><b>Oceanic</b></p> <ul style="list-style-type: none"> <li>• CDI full-scale deflection: 2.0 nm</li> </ul>
TERM	<p><b>Terminal</b></p> <ul style="list-style-type: none"> <li>• CDI full-scale deflection: 2.0 nm or current CDI scale selection, whichever is smaller</li> </ul>
VISUAL	<p><b>Visual Approach</b></p> <ul style="list-style-type: none"> <li>• Vertical guidance based on advisory terrain avoidance calculations</li> <li>• CDI scaling is identical to LPV approaches</li> </ul>

# Departures

## Loading a Departure into Flight Plan

- Flight plans allow only one departure procedure at a time
- Loading a departure when one is already present will replace the existing entry
- Selecting a departure, transition waypoint, and runway defines the route

### FEATURE LIMITATIONS

- *Vector-only departures may be excluded from some databases*

## PAGE SPECIFIC CONTROLS

**Load Departure:** Loads departure procedure into the active flight plan.

## SELECT A DEPARTURE

**From the Home page:**

1. Tap **PROC > Departure**.
2. Confirm the selected airport. If necessary, tap **Airport** and choose an airport using the provided search options.
3. Tap **Departure** and select a departure from the list.
4. Tap **Transition** and select a transition.
5. Tap **Runway** and select a runway.
6. Tap **Preview**, then review the departure diagram and sequence list.
7. Tap **Load Departure**, then scroll the flight plan to view all departure waypoints.

**To change the departure:**

Tap the existing flight plan departure and select a different one.

If the selected runway displays a "B," such as "RW10B," this means the selected runway is both 10L and 10R.

## Flight Plan Departure Options

### Departure Options

- Select Departure
- Remove Departure

Selecting a departure on the flight plan opens a menu. Changes to the active flight plan take effect immediately.

- Select a new departure
- Remove the selected departure from the flight plan

# Arrivals

## Loading an Arrival into Flight Plan

- Load a Standard Terminal Arrival (STAR) at any airport with a published arrival procedure
- Flight plans allow only one arrival procedure at a time
- Loading an arrival when one is already present will replace the existing entry
- Selecting an arrival, transition waypoint, and runway defines the route

## PAGE SPECIFIC CONTROLS

**Load Arrival:** Loads arrival procedure into the active flight plan.

## SELECT AN ARRIVAL

**From the Home page:**

1. Tap **PROC > Arrival**.
2. Confirm the selected airport. If necessary, tap **Airport** and choose an airport using the provided search options.
3. Tap **Arrival >** Select an arrival from the list.
4. Tap **Transition >** Select a transition.
5. Tap **Runway >** Select a runway.
6. Tap **Preview >** Review the arrival diagram and sequence list.
7. Tap **Load Arrival**. The Active FPL page opens.
8. Scroll the flight plan to view all arrival waypoints.

**To change the arrival:**

Tap the existing flight plan arrival and select a different one.

## Flight Plan Arrival Options

### Arrival Options

- Select Arrival
- Remove Arrival

Selecting an arrival on the flight plan opens a menu. Changes to the active flight plan take effect immediately.

- Select a new arrival
- Remove the selected arrival from the flight plan

# Approaches

## Loading an Approach into Flight Plan

- Always check the runway, transition, and all waypoints
- Flight plans allow only one approach procedure at a time
- You may load an alternate approach during a missed approach procedure (flight plan retains all missed approaches)
- Loading an approach when one is already present will replace the existing entry
- Loading and not activating an approach does not remove the approach airport from the flight plan
- Selecting an approach, transition waypoint, and runway defines the route

## PAGE SPECIFIC CONTROLS

**Load Approach:** Loads approach procedure into the active flight plan.

**Load Approach & Activate:** Loads approach procedure into the active flight plan and activates the approach.

**Channel/ID:** Loads an SBAS approach based on the specified channel.

## SELECT AN APPROACH

From the Home page:

1. Tap **PROC > Approach**.
2. Confirm the selected airport. If necessary, tap **Airport** and choose an airport using the provided search options.
3. Tap **Approach** and select an approach from the list.
4. Tap **Transition** and select a transition.
5. Tap **Load Approach**. The Active FPL page opens.
6. Scroll the flight plan to view all approach waypoints.

### To change the approach:

Tap the existing flight plan approach and select a different one.

### SBAS APPROACHES

#### Channel ID Key

- Select the channel ID for an SBAS approach to the current destination
- Provides an alternate means of loading an approach.
- IDs are available from an approved approach chart
- In the case of duplicate numbers, select an approach from the provided list

To load an SBAS approach:

1. Tap **Channel/ID**.
2. Specify an approach channel.

If present, both channel and ID load automatically.

### SUSPENDED APPROACH PROCEDURE ANNUNCIATION

“SUSP” indicates that automatic sequencing of approach waypoints is suspended on the active leg. This annunciation appears in the procedure field of the annunciator bar.

Suspended approaches typically occur during:

- Holding patterns
- Crossing the missed approach point
- Climb to altitude legs
- Hold to altitude legs

## PROCEDURE TURNS

### Roll Steering & Procedure Turns

The steering provided for a procedure turn does not guarantee that the aircraft will stay within the charted procedure turn boundaries. Always be sure to fly within the confines of the charted procedure.

A procedure turn is stored as another approach leg. It does not require any special operations other than flying the procedure itself.

Roll steering is available for aircraft with a compatible autopilot.

## Flight Plan Approach Options

### Approach Options

- Activate Approach
- Activate Vectors to Final
- Activate Missed Approach
- Select Approach
- Remove Approach

Selecting an approach on the flight plan opens a menu. Changes to the active flight plan take effect immediately.

- Activate the selected approach
- Activate vectors to final for the selected approach
- Activate a missed approach
- Select a new approach
- Remove the selected approach from the flight plan

### Missed Approach

The method for activating a missed approach depends on your position in relation to the missed approach point.

#### BEFORE MISSED APPROACH POINT

Select **Activate Missed Approach**. This function is available in two applications:

*Active FPL:*

Home > **Flight Plan** > Select the approach > **Activate Missed Approach**

*Procedures:*

Home > **Procedures** > **Activate Missed Approach**

Once selected, guidance continues along an extension of the final approach course (i.e., final approach fix to missed approach point).

The unit automatically sequences to the first leg of the missed approach. This allows you to execute the missed approach prior to reaching the missed approach point.

#### CROSSING MISSED APPROACH POINT

When crossing the missed approach point:

- “SUSP” annunciation indicates that approach waypoint sequencing is suspended at the missed approach point
- FROM/TO flag on the CDI indicates “From” for non-composite CDIs
- FROM/TO field on the annunciator bar indicates “FR”
- Course guidance continues along the final approach course

If you need to go around the holding pattern again to lose extra altitude or speed, tap **SUSP** to manually suspend waypoint sequencing before crossing the holding waypoint the second time.

If you have already passed the waypoint, re-activate the holding pattern.

## AFTER MISSED APPROACH POINT

Upon reaching the missed approach point, a pop-up presents two options.



To continue with sequencing suspended, tap **Remain Suspended**.

To receive guidance to the missed approach hold point, tap **Activate GPS Missed Approach**.

## Approach Hold

### Hold Options

- Activate Hold
- Insert After
- Edit Hold
- Exit Hold
- Remove

Selecting an approach hold on the flight plan opens a menu. Changes to the active flight plan take effect immediately.

- Activate the selected hold
- Insert a waypoint after the hold
- Edit hold details
- Exit the holding pattern
- Remove the selected hold from the flight plan

### ACTIVATE HOLD



1. Select the hold.
2. Tap **Activate Hold**.
3. Confirm the request.

### REMOVE HOLDING PATTERN

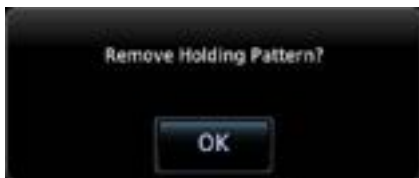

1. Select the hold.
2. Tap **Remove**.
3. Confirm the request.

### EXIT HOLDING PATTERN



1. Select the hold.
2. Tap **Exit Hold**.
3. Confirm the request.

## NON-REQUIRED HOLDING PATTERNS



Upon activating an RNP GPS approach, decide whether to skip non-required holding patterns during the initial transitions of the approach.

A pop-up presents two options.



Selecting **Yes** adds the hold to the flight plan.

Preview shows the hold in white.



Selecting **No** means the hold is not included in the flight plan.

Preview shows the hold in gray.

Timer/Distance field displays on the active flight plan (refer to when flying the outbound portion of the holding pattern). Holding pattern appears on Map with the active flight plan leg indication.

## DME Arc

### DME Arc Approaches

- Left/right guidance relative to the arc
- Manual arc leg activation once aircraft is near the arc

The unit supports approaches containing DME arcs.

To manually activate DME Arc, the aircraft must be within the shaded area.

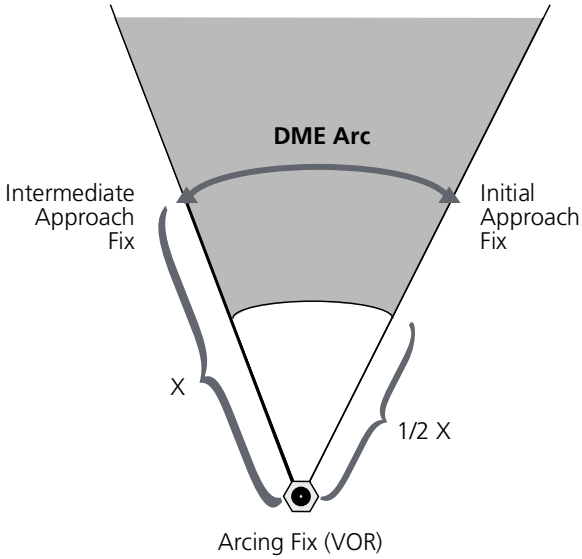

## RF Legs

### AC 90-101A - RF Legs

AC 90-101A defines RF leg as “A constant radius circular path, around a defined turn center, that starts and terminates at a fix. An RF leg may be published as part of a procedure.”

The unit supports radius-to-fix (RF) legs associated with RNAV RNP 1.0 non-AR approaches, when approved by the installation.

Flying a radius-to-fix approach is similar to flying a DME arc approach (status indications are identical).

Unlike DME arcs, however, RF legs are not based on a VOR. They may have varying radii, making them larger or smaller than arc legs.

For details regarding RF legs for specific aircraft, consult the AFMS.

## Vectors to Final



Activating the approach with vectors to final displays an extension of the final approach course on Map.



Magenta depicts the active leg of the flight plan. CDI needle remains off center until you are established on the final approach course.

As a reminder, “vtf” annunciates as part of the active leg on the GPS Nav status bar.

Activating vectors-to-final while on the From side of the final approach fix suspends automatic waypoint sequencing. “SUSP” annunciates at the bottom of the screen. Sequencing resumes once the aircraft is on the To side of the final approach fix and within full-scale deflection.

### ILS Approach



#### NOTE

*ILS and LOC approaches are not approved for GPS. GPS guidance is for monitoring purposes only.*



Selecting an ILS or LOC approach results in a pop-up message. Activate the approach or select a different one.

Do not attempt to use the unit as the primary navigation source during ILS approach.

### RNAV Approaches

#### **Always fly to the published minimums for:**

- LNAV/VNAV
- LNAV
- LNAV+V
- LPV
- LP
- LP+V

Fly RNAV approaches according to the published chart.

## LNAV APPROACH

RNAV non-precision lateral navigation approach.

## LNAV+V APPROACH

RNAV non-precision LNAV approach with advisory vertical guidance.

The glidepath is a light dashed line on the vertical profile (Jeppesen charts only) with an associated glidepath angle (usually in the 3.00 degree range) to assist in maintaining a constant vertical glidepath, similar to an ILS glideslope.

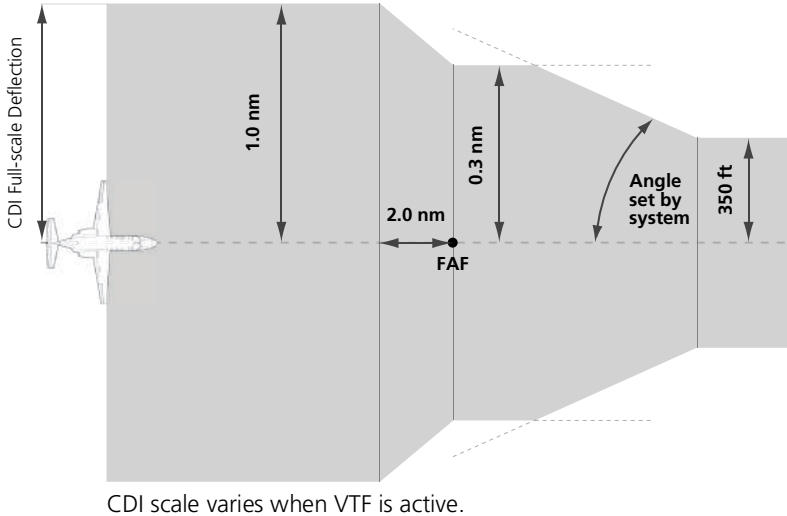

## LPV APPROACH

Localizer performance with vertical guidance. Similar to flying the standard ILS approach.

This segment describes a typical LPV approach sequence and the necessary pilot actions.

### Within 31 nm of destination:

- Mode switches from En Route to Terminal
- CDI scale transitions from 2.0 nm to 1.0 nm, full-scale deflection

### Approaching initial approach fix:

- Waypoint message annunciates
- Time to Turn advisory annunciates and 10 second timer counts down as the distance approaches zero

### Approaching final approach fix:

- Mode switches from Terminal to LPV

### 2.0 nm from final approach fix:

- CDI scaling tightens from 1 nm to the approach-defined angular full-scale deflection

### 60 seconds before final approach fix:

- System verifies GPS position integrity is within approach limits

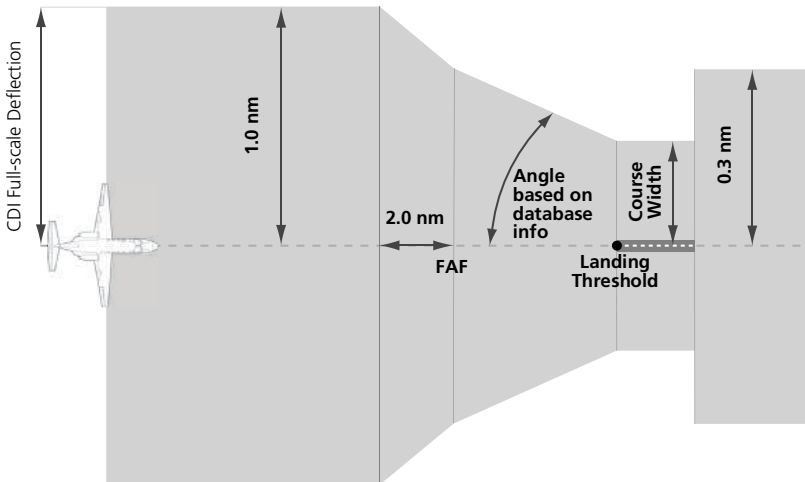

CDI scale varies when VTF is active.

If GPS integrity exceeds the horizontal and/or vertical alarm limits:

- Approach downgrades to non-precision
- “LNAV” annunciates on Map to inform of the change if there are LNAV minimums for the approach
- Advisory message: “GPS approach downgraded. Use LNAV minima.”
- Glideslope indication disappears
- Pilot continues approach using LNAV non-precision minimums, if applicable

If GPS integrity does not meet the non-precision horizontal alarm limits:

- Advisory message: “Abort Approach. GPS approach is no longer available.”
- Pilot acknowledges message
- Unit reverts to terminal limits of 1 nm to support navigation to the missed approach

#### **When crossing the final approach fix:**

- Waypoint sequences to the missed approach point (e.g., RW31, the runway threshold)
- Pilot flies toward missed approach point, keeping the needle on the external CDI (or HSI) at center, and observing published altitude minimums
- Final course segment becomes the active flight plan leg on Map

#### **After the aircraft passes final approach fix:**

- Pilot captures the glidepath (method is same as for ILS glideslope)

#### **Approaching missed approach point:**

- Advisory message: “Arriving at Waypoint.”

#### **Crossing missed approach point:**

- Sequencing suspends
- Pop-up message: “Missed Approach Waypoint Reached”
- Pilot decides whether to remain suspended or activate the missed approach
  - Tapping **Remain Suspended** allows you to continue with sequencing suspended
  - Tapping **Activate GPS Missed Approach** allows you to continue with guidance to the missed approach hold point

#### **Prepare aircraft for missed approach operation:**

- Pilot taps **UNUSP** (sequences missed approach), then follows the unit provided guidance to the missed approach hold point and holds

### LP APPROACH

#### Points About LP Approaches

- Use SBAS accuracy, making them similar to an LNAV approach but more precise
- Combine the lateral accuracy of an LPV approach with the angular scaling of a localizer approach
- Often contain step-down altitudes
- Always result in a minimum descent altitude and missed approach point

This segment describes a typical LP approach sequence and the necessary pilot actions.

#### **Within 30 nm of destination:**

- Mode switches from En Route to Terminal
- CDI scale transitions from 2.0 nm to 1.0 nm, full-scale deflection

#### **Approaching initial approach fix:**

- Turn direction message annunciates
- Time to Turn advisory annunciates and 10 second timer counts down as the distance approaches zero

#### **Approaching final approach fix:**

- Unit begins to automatically rescale in an angular fashion, allowing you to fly as you would a standard localizer approach

#### **2.0 nm from final approach fix:**

- CDI scaling tightens from 2 degrees or 0.3 nm full-scale deflection, whichever is smaller

#### **60 seconds before final approach fix:**

- System verifies GPS position integrity is within the horizontal limits to complete the LP non-precision approach

If pilot exceeds the horizontal alarm limits:

- Approach downgrades to non-precision
- “LNAV” annunciates on Map to inform of the change
- Advisory message: “GPS approach downgraded. Use LNAV minima.”
- Pilot continues approach using LNAV non-precision minimums, if applicable

If GPS integrity does not meet the non-precision horizontal alarm limits:

- Advisory message: “Abort Approach. GPS approach is no longer available.”
- Pilot acknowledges message
- Unit reverts to terminal limits of 1 nm to support navigation to the missed approach

If the approach indicates “LP+V,” then advisory vertical guidance may be removed without annunciation. This is due to the vertical guidance not being within tolerances.

This does not constitute a downgrade. You may still fly the approach to LP minimums.

Flying an LP approach with advisory vertical guidance (LP+V) does not change how the approach should be flown. The pilot is still responsible for descending to the correct altitude at each step down.

The result is still an MDA and missed approach point.

### **When crossing the final approach fix:**

- Waypoint sequences to the missed approach point (e.g., RW31, the runway threshold)
- Pilot flies toward missed approach point, keeping the needle on the external CDI (or HSI) at center, observing published altitude minimums
- Final course segment becomes the active flight plan leg on Map

### **Approaching missed approach point:**

- Advisory message: “Arriving at Waypoint.”

### Crossing missed approach point:

- Sequencing suspends
- Pop-up message: "Missed Approach Waypoint Reached"
- Pilot decides whether to remain suspended or activate the missed approach
  - Tapping **Remain Suspended** allows you to continue with sequencing suspended
  - Tapping **Activate GPS Missed Approach** allows you to continue with guidance to the missed approach hold point

### Prepare aircraft for missed approach operation:

- Pilot taps **UNSUSP** (sequences missed approach)

**NOTE:** For missed approaches with heading legs, fly manually until you reach the first active course leg.

- Pilot follows the unit provided guidance to the missed approach hold point and holds

# Visual Approach

## Points About Visual Approaches

- Provide advisory horizontal and optional vertical guidance for the selected runway
- Lateral guidance is always provided for visual approaches
- Helps stabilize the runway approach
- Three methods for loading and activation

### FEATURE REQUIREMENTS

- *Valid terrain database*

### FEATURE LIMITATIONS

- *Not all airports in the database support visual approaches*

Published data is used to determine the visual approach GPA and threshold crossing height (TCH) for the selected runway. If no published data is available, the default is 3 degrees GPA and 50 ft TCH.

You may load and activate a visual approach from the following apps.

- Map
- Procedures
- Waypoint Info



Upon loading the visual approach, a pop-up informs when vertical guidance is available.

If available, the pop-up contains the glidepath angle (GPA) and threshold crossing (TCH).

If unavailable, it reads: “NO VERTICAL GUIDANCE”

Terrain and obstacle obstructions along the approach path determine the availability of vertical guidance advisories for visual approaches.

- If no known obstructions are within the approach path, vertical guidance is provided to a maximum distance of 28 nm from the runway.
- If there are known obstructions further than 3 nm, but within the 28 nm maximum distance from the runway along the approach, vertical guidance is limited to the approach path after crossing the known obstructions. After loading the approach, a shortened magenta line shows on the map.

If obstructions are within 3 nm to the runway, along the approach path, advisory vertical guidance is not available.

### LOAD A VISUAL APPROACH FROM MAP

When the aircraft is within 10 nm of the destination airport, the **Visual Approach** selector key becomes active. This key may appear in one of two places:

On the map or at the left of the screen if the supporting airport is selected.

1. Select the airport icon.
2. Tap **Visual**.
3. Select from the list of available visual approaches.

Once selected, the visual approach immediately loads and activates.

For more about **Visual Approach** key configuration, refer to *Map Setup*.

### LOAD A VISUAL APPROACH FROM PROCEDURES

Two methods:

Home > **PROC** > **Approach**

**OR**

Home > **Waypoint Info** > **Airport** > **PROC** > Select an approach (similar to published instrument approaches)

## Autopilot Outputs



### CAUTION

Engage the autopilot heading mode and set the heading bug appropriately to use the autopilot on heading legs using the autopilot's NAV, GPSS, or APR mode. Not all autopilots follow guidance on these leg types, Some revert to a roll only or wings level mode.

#### FEATURE REQUIREMENTS

- Availability dependent upon configuration

#### FEATURE LIMITATIONS

- Applicable to King KAP 140 and KFC 225 autopilots



Outputs for the King KAP 10/KFC 225 autopilot units require manual activation.

#### APR Guidance Advisory, GTN 650Xi



If configured, this function prompts you to enable autopilot outputs during the approach procedure.

Once enabled, the unit provides guidance information consistent with what the autopilot expects (i.e., angular CDI scaling and glideslope capture for LPV or other vertically guided GPS approaches).

### ENABLE AUTOPILOT OUTPUTS

1. Acknowledge the advisory message.
2. Tap **Enable APR Output**.
3. Follow the unit provided guidance.

INTENTIONALLY LEFT BLANK

# 4 Planning

VCALC .....	4-4
TRIP PLANNING .....	4-7
FUEL PLANNING .....	4-11
DALT/TAS/WIND CALCULATOR .....	4-15
RAIM PREDICTION.....	4-18
CHECKLISTS.....	4-20

### PLANNING APPS & FUNCTIONS

The following features make flight planning easier and more efficient.



#### **VCALC**

*Input:*

- Target Altitude
- Altitude Profile
- Target Waypoint

*GTN computes:*

- Time to TOD
- VS Required



#### **Trip Planning**

*Input:*

- Route
- Depart Date/Time
- Ground Speed

*GTN computes:*

- DIS
- DTK
- ESA
- ETA
- ETE
- Sunrise/Sunset



#### **RAIM Prediction**

*Input:*

- Waypoint
- Arrival Date/Time

*GTN computes:*

- RAIM Status

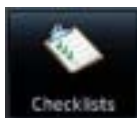

#### **Checklists**

- Review and complete aircraft checklists



### Fuel Planning

*Input:*

- Route
- Fuel Data
- Ground Speed

*GTN computes:*

- Fuel Required
- Reserve
- Range
- Efficiency
- Endurance



### DALT/TAS/Winds

*Input:*

- Air Data
- Track
- Heading
- Ground Speed

*GTN computes:*

- Density ALT
- TAS
- Wind Direction
- Wind Speed
- Head Wind

VCALC and VNAV are mutually exclusive. Which app you have is dependent upon installer configuration. For information about VNAV functions and operations, read *En Route Vertical Navigation* in section 3.

# VCALC



Calculate time to TOD and vertical speed required to reach target altitude at the specified location.



## WARNING

**DO NOT RELY ON VCALC MESSAGES AS THE ONLY MEANS OF EITHER AVOIDING TERRAIN/OBSTACLES OR FOLLOWING ATC GUIDANCE. VCALC PROVIDES ADVISORY INFORMATION ONLY AND MUST BE USED IN CONCERT WITH ALL OTHER AVAILABLE NAVIGATION DATA SOURCES.**

### FEATURE LIMITATIONS

This feature is inhibited when:

- Groundspeed is < 35 knots
- No active flight plan or direct-to destination is available
- One of the following modes is active: SUSP, Vectors-to-Final, OBS
- Navigating to a waypoint after the FAF

## Define a VCALC Profile

### WHERE TO FIND IT

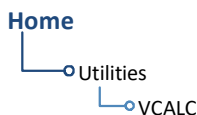

With the Vertical Calculator (VCALC) feature, you can create a 3-D profile to guide you from your present position and altitude to a final (target) altitude at a specified location. Once defined, you may configure message alerts and additional data on Map to stay informed of your progress.



Creating a profile is helpful when you want to descend to a certain altitude near an airport.

### VCALC Profile Selections

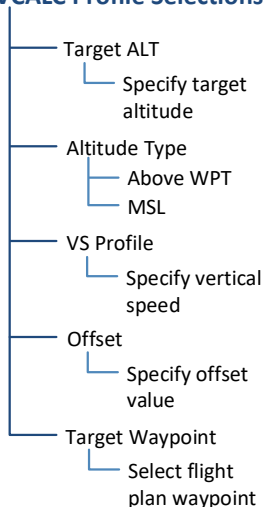

Profile selections allow you to:

- Specify a target altitude and offset
- Choose a target type
- Specify vertical speed
- Select a target waypoint from the active flight plan

<b>Target ALT</b>	<ul style="list-style-type: none"> <li>• Specify the final (target) altitude for the course</li> </ul>
<b>Altitude Type</b>	<ul style="list-style-type: none"> <li>• Altitude reference used for VCALC calculations</li> <li>• Toggles between “MSL” and “Above WPT”</li> <li>• Above WPT is available for airports only</li> </ul>
<b>VS Profile</b>	<ul style="list-style-type: none"> <li>• Specify the vertical speed value</li> </ul>
<b>Offset</b>	<ul style="list-style-type: none"> <li>• Distance value representing the geographical location at the target altitude</li> <li>• Distance is measured from the target waypoint along the flight path</li> </ul>
<b>Before/After</b>	<ul style="list-style-type: none"> <li>• Select whether the offset distance defines a point before or after reaching the target waypoint</li> <li>• “After” option not available for last destination in flight plan (key changes to a non-selectable “Before” indication)</li> </ul>
<b>Target Waypoint</b>	<ul style="list-style-type: none"> <li>• Reference location specified in the flight plan or active direct-to that will be used for planning a descent</li> <li>• When using a flight plan, the target waypoint is a reference that can be specified from the waypoints in the flight plan</li> <li>• Last waypoint in the flight plan is the default target setting</li> </ul>

### STATUS & VS REQUIRED INDICATIONS



#### Status

VCALC status messages display here.

#### VS Required

Shows the vertical speed required to reach target altitude and offset.

## VCALC Setup



Setup options allow you to restore default app settings and display VCALC related advisory messages.

#### Restore Defaults

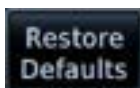

- Resets VCALC settings to their default values
- Excludes Target Waypoint

#### Display Messages

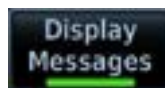

- Allows VCALC related advisory messages to display on the Messages page

### GTN 650Xi SERIES

#### VCALC Menu

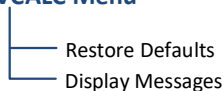

Tap **Menu** to access setup controls.

### GTN 750Xi SERIES

Setup controls reside on the profile page.

# Trip Planning



View DTK, DIS, ETE, ESA, and ETA information for a direct course between two specified waypoints or any programmed flight plan.

## WHERE TO FIND IT

Home



Utilities



Trip Planning

Trip statistics are based on route and ground speed.

## Trip Planning Modes

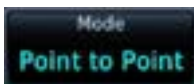

Tapping **Mode** toggles the active trip planning mode between Point to Point and Flight Plan. Point to Point is the default mode setting.

### Point-to-Point Mode

Calculate trip data between two waypoints in the database, or between the aircraft's present position and a selected waypoint.

### Flight Plan Mode

Calculate trip data for a specific flight plan leg, or for the cumulative flight plan.

Use the mode specific controls to define the flight path (leg or route). Required input values are dependent upon mode selection.

Departure date and time and ground speed data are required independent of mode selection.

MODE	SELECTION	DESCRIPTION
Point-to-Point	P. Position	<ul style="list-style-type: none"> <li>Enters the current aircraft coordinates as the departure location (or From waypoint)</li> <li>Aircraft latitude and longitude fields replace the From waypoint key</li> </ul>
	From	<ul style="list-style-type: none"> <li>Specify a waypoint from the database as the departure location (or From waypoint)</li> <li>Not available when P. Position is active</li> </ul>
	To	<ul style="list-style-type: none"> <li>Specify a waypoint from the database as the destination (or To waypoint)</li> </ul>
Flight Plan	Flight Plan	<ul style="list-style-type: none"> <li>Opens a list of available flight plans</li> <li>Options include the active flight plan or one from the catalog</li> <li>Defaults to the active flight plan if no selection is made</li> </ul>
	Leg	<ul style="list-style-type: none"> <li>Options dependent on flight plan selection</li> <li>Defaults to cumulative leg option if no selection is made</li> </ul>
Both	Depart Time	<ul style="list-style-type: none"> <li>Specify the departure time (local time at From waypoint)</li> </ul>
	Depart Date	<ul style="list-style-type: none"> <li>Specify the year, month, and day of departure</li> </ul>
	Use Sensor Data	<ul style="list-style-type: none"> <li>Utilize current GPS ground speed data</li> </ul>
	Ground Speed	<p>Behavior based on state of <b>Use Sensor Data</b> key.</p> <p><b>Use Sensor Data key inactive:</b></p> <ul style="list-style-type: none"> <li>Function selectable</li> <li>Specify ground speed</li> </ul> <p><b>Use Sensor Data key active:</b></p> <ul style="list-style-type: none"> <li>Function not selectable</li> <li>Displays current GPS ground speed when the <b>Use Sensor Data</b> key is active</li> </ul>

## COMPLETED LEG INDICATION



Dashes indicate when the selected flight plan leg is completed or the data cannot be computed.

# Trip Statistics

## Trip statistics include:

- Desired track (DTK)
- Distance (DIS)
- Destination sunrise/sunset times
- Est. time en route (ETE)
- Est. time of arrival (ETA)
- En route safe altitude (ESA)

Trip data calculations are based on the selected trip planning mode and specified input values.

**This information is for planning purposes only.**

## DESTINATION SUNRISE/SUNSET TIMES

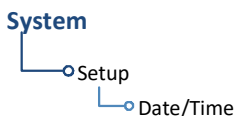

The time zone on which destination sunrise/sunset calculations are based depends on the system Time Format setting. This option resides in the System – Setup Date/Time feature.

**Local 12 or 24 hour.** Calculations are based on the time zone of the From waypoint. A flight plan originating in the Pacific time zone and ending in the Central time zone would show sunrise/sunset times at the destination in Pacific time.

**UTC.** Calculations use Universal Time Coordinated (time zones are not considered). There is no potential offset.

## ETA CALCULATIONS

The method for calculating ETA varies based on mode selection.

**Point-to-Point mode.**  $ETA = ETE + \text{departure time}$

**Flight Plan mode.** Calculations depend on flight plan selection:

If	Then
Active Flight Plan	<i>ETA reflects the present position and active leg:</i> $ETA = \text{current time} + ETE \text{ of each leg from the active leg up to and including the selected leg}$
Catalog Route	$ETA = \text{departure time} + ETE \text{ of each leg up to and including the selected leg}$

If you select the entire flight plan, the last leg of the flight plan is treated as the selected leg. This is true whether the selected flight plan is active or inactive.

### GTN 650Xi SERIES



To calculate trip data, enter all required input values and then tap **Compute Data**.



Statistics for the selected leg or route display on a dedicated data page.

To return to the data entry page, tap **Edit Input Data**.



### GTN 750Xi SERIES

Trip data calculates automatically upon entry. Statistics for the selected leg or route display on the lower half of the page.

### COMPUTE TRIP STATISTICS

1. Select a trip planning mode.
2. Define a leg or route.
  - If "Flight Plan" is set, select the flight plan and leg. Selecting the active flight plan sets the starting waypoint at the aircraft's current position.
  - If "Point to Point" is set, select From and To waypoints, or use the aircraft's current position as the From waypoint.
3. Specify the departure date and time.
4. Specify ground speed or elect to use sensor data.
5. Tap **Compute Data** (GTN 650Xi Series only).
6. Tap **Next** or **Prev** to view statistics for other legs in the flight plan (if applicable).

# Fuel Planning



View fuel conditions along any flight plan (active or cataloged) or between two waypoints (including the active direct-to).

## WHERE TO FIND IT

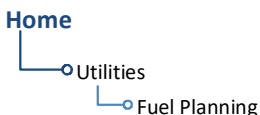

The fuel planning feature computes fuel conditions based on route, ground speed, fuel on board, and fuel flow.

Input values may be entered manually or supplied by sensors, if connected.

## Fuel Planning Modes

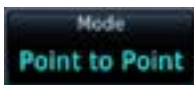

Tapping **Mode** toggles the active fuel planning mode between Point to Point and Flight Plan. Point to Point is the default mode setting.

### Point-to-Point Mode

Calculate fuel between two waypoints in the database, or between the aircraft's present position and a selected waypoint.

### Flight Plan Mode

Calculate fuel for a specific flight plan leg, or for the cumulative flight plan.

Use the mode specific controls to define the flight path (leg or route). Required input values are dependent upon mode selection.

Fuel on board, fuel flow, and ground speed data are required independent of mode selection.

### For Planning Purposes Only

- When interfaced with a Garmin EIS, Fuel on Board and Fuel Flow values are supplied by EIS. If an EIS is not present, or if the Use Sensor Data function is not active, these values are specified by the pilot and are not an indication of actual fuel on board or fuel flow.
- Fuel Required to <destination> is a calculated prediction. It is not a direct indication of actual fuel quantity once the aircraft reaches its destination.
- All data entries on this page are used exclusively by the Fuel Planning app.
- Fuel computations are for planning purposes only.

MODE	SELECTION	DESCRIPTION
Point-to-Point	P. Position	<ul style="list-style-type: none"> <li>Enters the current aircraft coordinates as the departure location (or From waypoint)</li> <li>Aircraft latitude and longitude fields replace the From waypoint key</li> </ul>
	From	<ul style="list-style-type: none"> <li>Specify a waypoint from the database as the departure location (or From waypoint)</li> <li>Not available when P. Position is active</li> </ul>
	To	<ul style="list-style-type: none"> <li>Specify a waypoint from the database as the destination (or To waypoint)</li> </ul>
Flight Plan	Flight Plan	<ul style="list-style-type: none"> <li>Opens a list of available flight plans</li> <li>Options include the active flight plan or one from the catalog</li> <li>Defaults to the active flight plan if no selection is made</li> </ul>
	Leg	<ul style="list-style-type: none"> <li>Options dependent on flight plan selection</li> <li>Defaults to cumulative leg option if no selection is made</li> </ul>
Both	Fuel on Board	<ul style="list-style-type: none"> <li>Specify the amount of fuel on board (gallons)</li> <li>Amount decreases once per second based on specified fuel flow value or sensor data</li> </ul>
	Fuel Flow	<ul style="list-style-type: none"> <li>Specify the current fuel flow rate (gallons per hour)</li> </ul>
	Use Sensor Data <sup>[1]</sup>	<ul style="list-style-type: none"> <li>Toggle on to utilize current GPS ground speed data and fuel sensor data (if available)</li> <li>Toggle off for manual data entry</li> </ul>
	Ground Speed	<ul style="list-style-type: none"> <li>Specify ground speed</li> </ul>

[1] When inactive, ground speed and fuel data functions are selectable. When active, these functions are not selectable.

Adjust fuel on board and fuel flow values as necessary to account for changes in performance.

# Fuel Statistics

## Fuels statistics include:

- Fuel required for leg
- Fuel after leg
- Reserve after leg
- Range
- Efficiency
- Endurance

Compute and display fuel data based on the selected fuel planning mode and specified input values.

**This information is for planning purposes only.**

## GTN 650Xi SERIES



To calculate fuel data, enter all required input values and then tap **Compute Data**.



Statistics for the selected leg or route display on a dedicated data page.

To return to the data entry page, tap **Edit Input Data**.



## GTN 750Xi SERIES

Fuel data calculates automatically upon entry. Statistics for the selected leg or route display on the lower half of the page.

### COMPUTE FUEL STATISTICS

1. Select a fuel planning mode.
2. Define a leg or route.
  - If “Flight Plan” is set, select the flight plan and leg. Selecting the active flight plan sets the starting waypoint at the aircraft’s current position.
  - If “Point to Point” is set, select From and To waypoints, or use the aircraft’s current position as the From waypoint.
3. Specify the amount of fuel on board and average fuel flow rate.
4. Specify ground speed or elect to use sensor data.
5. Tap **Compute Data** (GTN 650Xi Series only).
6. Tap **Next** or **Prev** to view statistics for other legs in the flight plan (if applicable).

If total fuel quantity or fuel flow values are supplied via sensor, GTN uses the data from this app to calculate the Fuel Range Ring overlay on Map. Fuel range rings indicate an estimate of remaining flight distance based on fuel onboard, fuel consumptions rates, and current ground speed.

Map depicts two separate rings: one displaying range to reserve fuel, the other displaying total endurance range. Both offer additional situational awareness regarding fuel remaining and endurance.

# DALT/TAS/Wind Calculator



Calculate density altitude, true airspeed, and winds.

## FEATURE REQUIREMENTS

- *Air data computer for automatic data entry*
- *Valid sensor data*

*An air data computer is not required for manual data entry.*

## WHERE TO FIND IT



This function computes density altitude, true airspeed, and wind data to provide the theoretical altitude at which your aircraft performs. Information is based on several input variables, which may be provided manually or via an air data computer.

# Edit Input Data



Tapping **Use Sensor Data** inputs data from the connected sensors. When active, the available sensor data populate the appropriate fields.

Sensor data values are not selectable for editing. Toggle the function off for manual data entry.

<b>Indicated ALT</b>	<ul style="list-style-type: none"> <li>Specify indicated altitude value</li> <li>Use +/- keys to indicate above or below sea level</li> <li>Mutually exclusive with Pressure ALT<sup>†</sup></li> </ul>
<b>BARO</b>	<ul style="list-style-type: none"> <li>Specify barometric pressure value<sup>‡</sup></li> </ul>
<b>CAS</b>	<ul style="list-style-type: none"> <li>Specify calibrated air speed value</li> </ul>
<b>TAT</b>	<ul style="list-style-type: none"> <li>Specify true air temperature</li> <li>Use +/- keys to indicate above or below 0°</li> </ul>
<b>HDG</b>	<ul style="list-style-type: none"> <li>Specify heading value</li> </ul>
<b>TRK</b>	<ul style="list-style-type: none"> <li>Specify track angle value</li> </ul>
<b>Use Sensor Data</b>	<ul style="list-style-type: none"> <li>Inputs reference values (internal or received from air data computer)</li> <li>Replaces indicated altitude with pressure altitude received from fuel/air data computer</li> </ul>
<b>Ground Speed</b>	<ul style="list-style-type: none"> <li>Specify ground speed</li> </ul>

<sup>†</sup> Toggles to Pressure ALT indication when sensor data is in use and the sensor is providing pressure altitude.

<sup>‡</sup> Not present if Use Sensor Data is active and the ADC is providing pressure altitude.

# DALT/TAS/Wind Statistics

Compute and display density altitude and current wind conditions. Calculations are based on current input values.

**This information is for planning purposes only.**

## Density Altitude

- Pressure altitude corrected for nonstandard temperature
- Units display in increments of ten

## Wind Data

- Wind direction and speed
- Headwind
- True air speed

Density altitude and true airspeed calculations are dependent on indicated altitude, barometric pressure, and total air temperature. Total air temperature includes temperature and the heating effect of speed, as read on a standard outside temperature gauge.

Wind data calculations are dependent on aircraft heading and track, true airspeed, and ground speed.

Wind direction is dependent on the NAV Angle system unit setting.

If wind speed is zero, wind direction displays as dashes.

## GTN 650Xi SERIES



To calculate density altitude and wind data, enter all required input values and then tap **Compute Data**.



Statistics display on a dedicated data page.

To return to the data entry page, tap **Edit Input Data**.



## GTN 750Xi SERIES

Data calculates automatically upon entry. Statistics for the selected leg or route display on the lower half of the page.

## INVALID INPUT DATA INDICATION

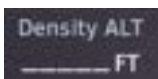

Dashes indicate when input values are invalid.

# RAIM Prediction



Determine GPS coverage availability for the current location or a specified waypoint at any time and date. RAIM performs checks to ensure that the navigator has adequate satellite geometry during flight.



## NOTE

RAIM availability prediction is for use in areas where WAAS coverage is not available. It is not required in areas where WAAS coverage is available.

### FEATURE REQUIREMENTS

- *Active flight plan or off-route direct-to waypoint (arrival date and time)*

### FEATURE LIMITATIONS

*FAA's TSO requirements for non-precision approaches specify significantly greater satellite coverage than is required during other phases of flight. As a result, RAIM may not be available for all approaches.*

*RAIM prediction results are valid for up to 90 days from the current date. Arrival dates beyond 90 days, or in the past, may not provide accurate results.*

*This feature predicts the availability of fault detection integrity. It cannot predict the availability of LPV or L/VNAV approaches.*

Use a non-GPS based approach when RAIM is not available. To determine WAAS availability, including for LPV approaches, visit the FAA's NOTAM service.

### WHERE TO FIND IT



This feature can help you plan for a pending flight by confirming GPS operation before an approach.

### RAIM Features

- Automatically monitors RAIM during approach operations and warns when RAIM is not available
- Near 100% availability in Oceanic, En route, and Terminal phases of flight
- **Waypoint Identifier**, **Arrival Date**, and **Arrival Time** setup keys
- **Compute RAIM** key

# Calculate RAIM Status



Calculate RAIM availability for the specified waypoint, date, and time. Prediction results announce once the calculation is complete.

## WAYPOINT SEARCH OPTIONS

A **Waypoint Identifier** key allows you to specify a destination airport using multiple search options.

## ARRIVAL DATE & TIME

These setup controls allow you to set the expected date and time of arrival at the specified airport. Values default to the current date and time in the absence of an active flight plan and off-route direct-to waypoint.

## CHECK RAIM AVAILABILITY

1. Specify a destination waypoint.
2. Specify the expected arrival date and time.
3. Tap **Compute RAIM**.

## RAIM STATUS INDICATIONS

Dashes indicate when the destination waypoint is invalid.

ANNUNCIATION	DESCRIPTION
Computing	Status is pending.
RAIM Available	RAIM is available at the specified waypoint.
RAIM Unavailable	RAIM is not available at the specified waypoint.

# Checklists

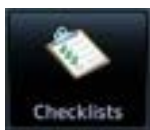

Review an electronic version of your aircraft checklist(s). Depending on the number of inspection items, these lists may be scrollable.

This icon appears only when GTN detects a checklist on your SD card



## NOTE

Garmin strongly recommends the author of the checklist file to carry out a functional system test prior to in-flight use. Validation should be carried out on the GTN Xi Series hardware while the aircraft is on ground.

### FEATURE REQUIREMENTS

- SD card for storing checklist files
- Garmin Aviation Checklist Editor software tool for authoring and grouping

### FEATURE LIMITATIONS

- Check boxes automatically clear following a unit power cycle
- Feature title dependent on installer configuration

### WHERE TO FIND IT

Depending on configuration, this feature may be titled "Checklists" or "Task Lists."



## Disclaimer

Operational approval may be required for the use of any electronic checklist developed for certified aircraft. Any checklist created with the checklist tool for certified aircraft may require additional operational airworthiness approval and cannot replace the official Flight Manual and/or checklist required by the Type Certificate or Supplemental Type Certificate.

**Do not use an unapproved checklist during flight operations.**

User generated checklists are created using the free Aviation Checklist Editor software available at [flyGarmin.com](http://flyGarmin.com).

Define properties for groups, checklists, and new entries using the features provided in the software tool.

Save checklists in the *chklist.ace* format. Copy the file to the root folder of an SD card.

For download instructions and system requirements, visit the Aviation Product Support page at [flyGarmin.com](http://flyGarmin.com).

# View a Checklist

## Checklist Menu

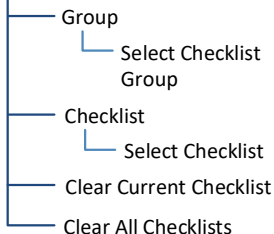

Tap **Menu** to access available group and checklist selections. Functions for clearing check boxes on the active list and all other checklists on the datacard also reside here.

<b>Group</b>	Select from the list of existing groups. Group properties are defined during checklist creation.
<b>Checklist</b>	Select a checklist for viewing and completion.
<b>Clear Current Checklist</b>	Clears all check boxes for the active list.
<b>Clear All Checklists</b>	Clears the check boxes for all available checklists on the installed SD card.

## CHECK BOXES

To mark an item as completed, tap the corresponding check box.



- A check mark appears next to the list item
- The item description turns green

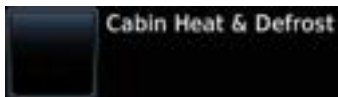

Deselected

Tapping the box again deselects the item.

### LIST STATUS ANNUNCIATIONS

Completion status annunciates at the bottom of the list.

A black rectangular box with the text "LIST NOT FINISHED" in white, bold, uppercase letters.

One or more list items are not marked as complete. Review the list and complete the remaining inspection items.

A black rectangular box with the text "LIST IS FINISHED" in green, bold, uppercase letters.

All check boxes are marked as complete. Proceed to the next checklist or select a different list from the menu.

### COMPLETE A CHECKLIST

1. Insert SD card containing the file titled *chcklist.ace*.
2. Open the Checklist menu (Home > **Utilities** > **Checklists** > **Menu**).
3. Select a group.
4. Select a checklist.
5. Select **Clear Current Checklist** or **Clear All Checklists** (if necessary).
6. Review and complete all inspection items.

Upon completion, select from the following options.

- *Advance to the next available checklist:* Tap **Go to Next Checklist**.
- *Exit the function:* Tap **Back**.
- *Select another checklist:* Tap **Menu** and select another group and/or checklist.

# 5 Hazard Awareness

WEATHER AWARENESS .....	5-3
TRAFFIC AWARENESS .....	5-69
TERRAIN AWARENESS .....	5-97

### HAZARD AWARENESS APPS & FUNCTIONS

Menu selections vary based on features and optional equipment installed with Garmin avionics.



#### Traffic

- Display traffic
- Control traffic system
- Set up the traffic display



#### Terrain

- Display terrain & obstacles
- Inhibit alerting
- Test alerting



#### Weather

Access available weather apps. Depending on unit configuration these may include:

- SiriusXM WX
- FIS-B WX
- Connex WX
- Stormscope
- Radar

# Weather Awareness



For installations with multiple weather sources, tapping the **Weather** icon on the Home page opens a menu. Available options are dependent upon the installed weather sources.

For installations with only a single weather source, tapping the icon takes you directly to the configured application.

## Datalink Weather



GTN presents datalink weather data as overlays on the dedicated weather app. Available functions are dependent upon the active weather source(s).

The unit allows up to three datalink weather options:

- SiriusXM • FIS-B • Connex

### FEATURE REQUIREMENTS

- *FIS-B and GDL 88 or GTX 345 (FIS-B Weather)*
- *GSR 56 Iridium satellite transceiver (Connex Weather)*
- *GDL 69/69A SiriusXM receiver (SiriusXM Weather)*

All datalink weather apps share the same basic layout and features.

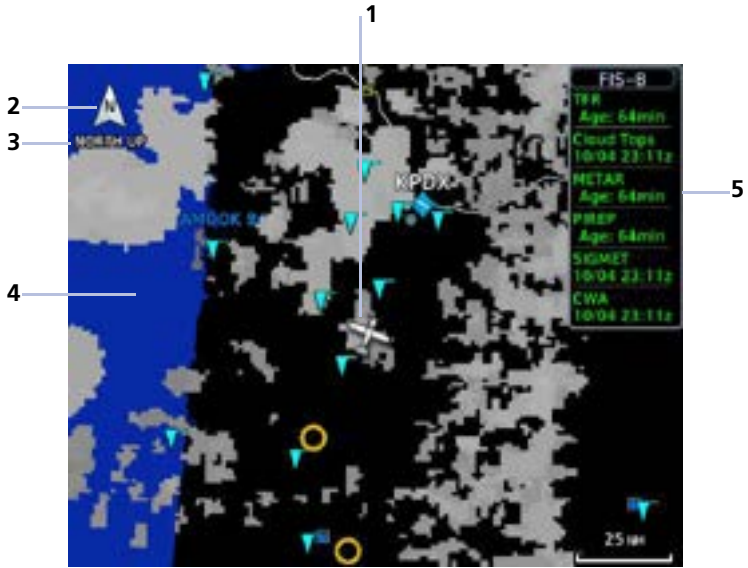

Common WX Display Features

1	<b>Aircraft Symbol</b> Depicts current aircraft position and orientation.
2	<b>North Indicator</b> Indicates True north.
3	<b>Page Orientation Label</b> Reflects the selected page orientation.
4	<b>Basemap</b> Presents a graphical depiction of land and water data.
5	<b>Product Timestamp</b> Approximate time of data collection for each active weather product.

## WX Info Banner

Tapping any weather icon displays an information banner. When applicable, a pop-up window displays additional data.

WX Info Banner



### Banner Information

- Pan mode symbol
- Bearing and distance to map pointer from aircraft's current position

## WX Display Orientation

Each weather app allows you to set the orientation of the weather display.

Tap **Menu > Orientation**, and select from the following options.

### North Up

Orients page to True north

### Track Up

Orients page to current aircraft GPS track

### Heading Up

Orients page to current aircraft heading (requires heading data source interface)

Page orientation label changes to reflect the selected orientation.

### Aircraft Symbol Position & Orientation

- The tip represents actual aircraft location
- Symbol type is dependent upon configuration
- This feature is absent if a GPS source is not available

# Datalink Weather Products



## WARNING

*Do not rely solely on datalink weather for weather information. Datalink weather provides a snapshot in time. It may not accurately reflect the current weather situation.*



## NOTE

*Datalink weather is not intended to replace weather briefings or in-flight weather reports from AFSS or ATC.*

In addition to the dedicated weather app, datalink weather products may display as one or more of the following, depending on weather source, product type and availability. For details, refer to the Datalink Weather Products List.



### Map

Some product overlays are available for display on Map. For options, open the Map Setup menu.



### Airport Info

Textual information about local weather conditions is accessible on the WX Data tab.



### WX Pop-up

Some product overlays display textual information when selected on Weather or Map.



### Raw Text Reports

Textual reports are available for certain FIS-B weather products. These are accessible via the Datalink Status page.

## DATALINK WEATHER PRODUCTS LIST

When available, datalink weather products display as follows.

DATALINK WEATHER PRODUCT	WEATHER DISPLAY				
	WX OVERLAY	WX POP-UP	MAP OVERLAY	AIRPORT INFO	RAW TEXT REPORT
AIREP	C, F, S	C, F, S			
AIRMET (Graphical)	F	F			
AIRMET (Textual)	C, S	C, S			
Cell Movement/SCIT	S	S	S		
Center Weather Advisory	F	F			F
City Forecast	S	S		S	
Cloud Top	F, S		S		
IR Satellite	C		C		
County Warnings	S	S			
Cyclone Track	S				
Echo Tops	S		S		
Freezing Levels	F, S				
Icing Potential/SLD	F, S				
Lightning (Datalink)	C, F, S		C, F, S		
METAR w/Decoding	C, F, S	C, F, S	C, F, S	C, F, S	F
NEXRAD/PRECIIP	C, F, S		C, F, S		
NOTAM-D <sup>†</sup>				F	F
NOTAM-FDC <sup>†</sup>				F	F
PIREP	C, F, S	C, F, S			F
SIGMET	C, F, S	C, F, S			F
Surface Analysis	S				
TAF	C, F, S	C, F, S		F, S	F
Temps Aloft	F				F
TFR <sup>†</sup>	C, F, S	C, F, S	C, F, S		F
Turbulence	F, S				
Winds Aloft	C, F, S				F

**Connex Product:** C

**FIS-B Product:** F

**SiriusXM Product:** S

<sup>†</sup> FIS-B NOTAMs and TFRs that do not contain geographical locations are not viewable on GTN.

# Product Age



## NOTE

*Data contained within a composite weather product may be older than its weather product age and should never be considered current.*

A timestamp identifies the approximate time of data collection for each weather product. For quick reference, the age of each active weather product is calculated and shown in a color-coded side bar on Weather and Map.

## TIMESTAMP COLOR DEFINITIONS



### Yellow

Weather product considered stale. Its age is older than half its expiration time.

A weather product may be amber when its issue date and time occurs in the future by more than the complete expiration time for the requested weather product (e.g., some TFRs).

---

### Green

Weather product considered current. Its age is newer than half its expiration time.

Tapping timestamp window displays the time for all green colored weather products.

---

### Gray

Weather product data is one of the following:

- Expired
- Not received
- Not supported at the selected altitude

“No Data” or “ALT UNAVBL” displays next to the weather product title.

## SiriusXM WX Product Age

- Broadcast intervals are defined and controlled by SiriusXM Satellite Radio and its data vendors
- Data that does not refresh within its defined interval is considered expired and removed from the display
- Product age may not reflect the time difference between when the data was assembled by SiriusXM and the current GPS time. It is an indication of the time elapsed from when it is received by GTN
- Timestamp collapses when all WX products are current

## Connex WX Product Age

- Product age is based on time difference between when the data was assembled by Connex and the current GPS time
- Product expiration is based on intervals defined for each product
- Pilot controls weather product requests
- Refresh intervals are defined and controlled by Connex Satellite Radio services and its data vendors
- Data is removed upon expiration, ensuring that displayed data is always consistent with what is currently being provided by Connex Satellite Radio services

FIS-B weather product update and transmission intervals are published in the SBS Description Document associated with TSO-C157b. This information is available electronically at the FAA's Regulatory and Guidance Library: <https://rgl.faa.gov/>

## Product Legends

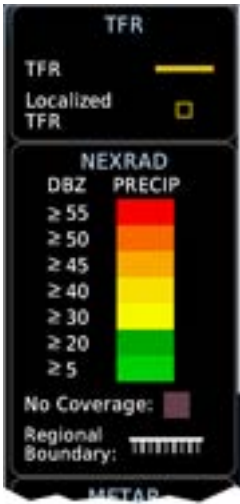

A scrollable legend provides relevant product colors and symbols. Definitions are organized by product function.

To display the legend for an active weather product, tap **Menu > Legend**.

Enabling this feature on one application does not enable it on all datalink weather apps.

### GTN 650Xi SERIES

Toggleing this feature on shows datalink weather product legends on a dedicated page.

### GTN 750Xi SERIES

Toggleing this feature on shows datalink product legends along the left side of the display.

## Altitude Adjustment Keys



Directional keys adjust altitude for altitude-based weather products. Selectable altitude values vary by weather service and product. Includes:

- Icing
- Turbulence
- Winds Aloft

## Airport Icons



Tapping the METAR symbol displays information about local weather conditions.

The same is true for airports containing the City Forecast product symbol (SiriusXM Weather only).



# Precipitation

AVAILABLE WITH:  
FIS-B | SIRIUSXM | CONNEXT



## WARNING

*Never use NEXRAD WEATHER for MANEUVERING IN, NEAR, OR AROUND AREAS OF HAZARDOUS WEATHER. Nexrad images are snapshots of past weather data. They are not safe for use as real time depictions of nearby weather activity.*

FIS-B NEXRAD



**CONUS NEXRAD**



**Regional NEXRAD**

NEXRAD weather radar displays a mosaic of precipitation data, colored according to reflectivity. Composite reflectivity images depict the highest radar energy received from multiple antenna tilt angles at various altitudes. Base reflectivity images depict radar returns from the lowest antenna tilt angle. Per AC 00-63A, FIS-B CONUS and Regional NEXRAD are composite reflectivity images.

The precipitation intensity level reflected by each pixel represents the highest level of composite radar reflectivity data sampled in that location.

A clear understanding of ground-based Doppler weather radar capabilities will allow you to interpret the NEXRAD weather imagery in the safest way possible. The National Oceanic and Atmospheric Administration hosts a description of the technology on its website: [https://www.weather.gov/jetstream/doppler\\_intro](https://www.weather.gov/jetstream/doppler_intro)

### RADAR DATA ANIMATIONS



To depict trending weather movements over time, an animation function stitches the last three to six received radar images together in sequence, from oldest to newest, and replays them on a continuous loop.



Play and stop controls are active when three or more images are available for playback.

### CONNEXT PRECIP



Precipitation products are available for areas around the world. For current coverage areas and product information, visit [www.garmin.com/connext](http://www.garmin.com/connext).

## FIS-B NEXRAD

FIS-B NEXRAD is uplinked to the aircraft as two separate weather products: CONUS and Regional NEXRAD. Both products display individually or simultaneously, separated by a white hash-marked boundary, based on source selection.

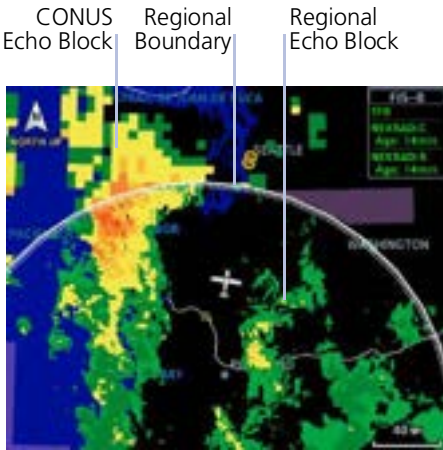

**CONUS & Regional NEXRAD Combined**

Depending on the locations of received FIS-B ground stations, Regional NEXRAD coverage can extend as far as 250 nm around an aircraft's position. Aircraft flying at higher altitudes typically receive data from more ground stations than aircraft flying at low altitudes.

FIS-B NEXRAD does not differentiate between liquid and frozen precipitation types.

### Source Options:

Source options are selectable from the FIS-B Weather menu or the **NEXRAD** key located in the control bar. The key label changes to reflect the active source.

---

#### CONUS



- Large, low-resolution weather image for the entire continental U.S.
- Pixels are 7.5 min (7.5 nm = 13.89 km) wide by 5 min (5 nm = 9.26 km) wide

---

#### Regional



- High-resolution weather image with limited range, centered around each broadcasting ground station
- Pixels are 1.5 min (1.5 nm = 2.78 km) wide by 1 min (1 nm = 1.852 km) tall
- Each weather pixel varies with latitude. Above 60° latitude, pixel block width doubles to 3 min/nm for regional maps

---

#### Combined



- Both CONUS and Regional NEXRAD images display simultaneously
- White hash mark indicates regional boundary

### SIRIUSXM NEXRAD

SiriusXM offers NEXRAD radar imagery from CONUS and non-CONUS sources. Weather menu options are Composite and Base.



Depending on the SXM service and installed GDL hardware, radar base reflectivity imaging may have broader coverage within North America or be limited to only Canada.

#### Source Options:



#### **Composite (CONUS)**

Composite reflectivity image of radar for the conterminous U.S.

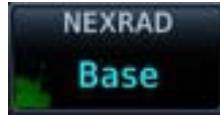

#### **Base**

Base reflectivity image. Coverage and availability are dependent upon subscription.

Precipitation above 52° N may display as mixed precipitation regardless of actual precipitation type. Precipitation of an unknown type always displays as rain.

# Textual AIRMETs



**AVAILABLE WITH:  
SIRIUSXM | CONNEXT**

An AIRMET advises of weather that may be particularly hazardous to single engine, light aircraft and VFR pilots. Overlays draw the geographical boundaries of received AIRMETs on the dedicated weather page.

*SiriusXM Textual AIRMETs*



Tapping an AIRMET opens a detailed report.

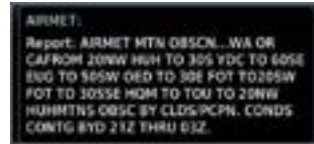

## AIRMET TYPES



### Icing

Areas of moderate airframe icing including areal extent.



### Turbulence

Areas of moderate turbulence including vertical extent.



### IFR

Weather conditions with ceilings <1,000 ft and/or visibility <3 mi.



### MTN OBSC

Widespread mountain obscuration due to clouds, precipitation, smoke, haze, mist, or fog.



### Surface Winds

Sustained surface winds >30 kt and/or potential non-convective wind shear below 2,000 ft AGL.

# Graphical AIRMETS



## AVAILABLE WITH: FIS-B

Graphical AIRMETS (G-AIRMETS) display more weather phenomena than textual AIRMETS, while eliminating the need to interpret raw text.



Tapping a G-AIRMET displays textual details.

Updates occur four times daily.



Filtering options allow you to mitigate page clutter. Forecast and filter selections are accessible from the FIS-B Weather menu.

### Forecast Settings:

#### Off

Disables automatic functionality.  
Filter options not available.

#### Current (Auto)







Displays active graphical records based on the current UTC.  
Function automatically switches from 0 hr to 3 hr forecasts.

#### All Forecasts

Displays the most recent, non-expired graphical records.

Forecast periods include 0 hr, 3 hr, and 6 hr.

## G-AIRMET FILTERS

	Freezing Level		MTN OBSCR
	Icing		Surface Winds
	IFR		Turbulence
	Low-level Wind Shear		

### To enable graphical AIRMETS:

1. Home > **Weather** > **FIS-B Weather** > **Menu**.
2. Tap **G-AIRMET** and select between **Current (Auto)** and **All Forecasts**.
3. Tap **G-AIRMET Filters** and select one or more filters.

# AIREPs



**AVAILABLE WITH:  
FIS-B | SIRIUSXM | CONNEXT**

AIREPs are routine, automated reports of in-flight weather conditions such as wind and temperature.

*SiriusXM AIREPs*



AIREPs display as a green map icon. Tapping this icon displays a report.

```
AIREP:  
Position: N 43°10.80' W126°24.60'  
Time: 18:00 UTC  
Wind Direction: 243°  
Wind Speed: 96 kt  
Altitude: 36000ft  
Temperature: -52°C  
  
Report: ARP HAL39 4318N 12641W 1800  
#360 H552 243/096KT TB SMTH=
```

## Cell Movements



### AVAILABLE WITH: SIRIUSXM

Information derived from NEXRAD displays the location of storm cells within a strong storm. Vector symbols represent cell position and direction of movement.



Tapping one of these symbols displays details about the cell's speed and direction as well as the storm's top altitude.

Cell Movement:  
 Speed: 17 kt  
 Direction: 102°  
 Top: 21500 ft

### Top Heights

Top height is reported as maximum altitude of reflected precipitation. Storm height may be higher than radar reflections. Top heights are reported in MSL.

# Center Weather Advisory



**AVAILABLE WITH: FIS-B**

These advisories communicate en route and terminal weather conditions expected to occur within the next two hours. Information is valid for up to 2 hours.

Tapping a CWA symbol displays textual details.



# City Forecast



**AVAILABLE WITH: SIRIUSXM**

Provides two-day forecasts for major U.S. cities, including daily forecast high and low temperatures, chance of precipitation, and sky conditions.

*City Forecast offers a 48 hour look ahead.*



Tapping a City Forecast symbol displays weather details.

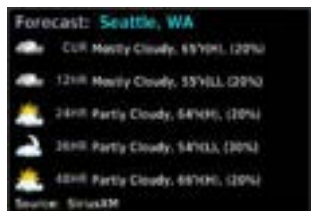

## Forecast Period Options:

- Current • 12 hour • 24 hour • 36 hour • 48 hour

# Clouds

## CLOUD TOPS



**AVAILABLE WITH:  
FIS-B | SIRIUSXM**

*FIS-B Cloud Tops*

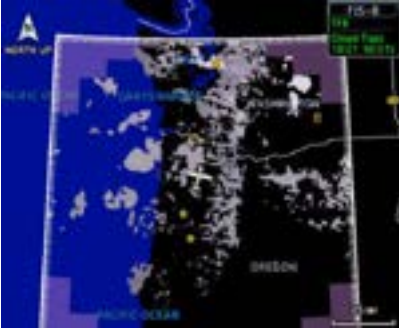

Indicates the altitude of the highest visible portions of a cloud at the time of measurement.

- SiriusXM cloud top altitude data is estimated from IR satellite imagery
- FIS-B cloud top data is generated by a computer model and has limited accuracy compared to actual conditions

## IR SATELLITE

**AVAILABLE WITH: CONNEXT**



Infrared Satellite weather information is available for North America and Europe. Updates occur every 30 minutes.

- Lighter grays depict colder temperatures
- Darker grays depict warmer temperatures

# County Warnings



AVAILABLE WITH: SIRIUSXM

County warnings are provided for the counties within the continental United States. Specific public awareness and protection alerts, such as fires and natural disasters, are included with warnings for tornadoes, thunderstorms, floods and flash floods.



Tapping a County Warning symbol displays weather details.



Symbols include: • Severe T-Storm • Tornado • Flooding

# Cyclone



AVAILABLE WITH: SIRIUSXM



Displays tropical storm information as issued by the National Hurricane Center. Includes the cyclone's location, projected path, date, and time.

## Echo Tops

AVAILABLE WITH: SIRIUSXM



Depicts the location, elevation, and direction of NEXRAD radar echoes. This information is useful for gauging storm intensity in a relative sense. A higher radar echo means a stronger storm updraft.

## Freezing Levels

AVAILABLE WITH:  
FIS-B | SIRIUSXM



*SiriusXM Freezing Level*



Color-coded contour lines indicate the altitude of the freezing level.

When freezing data is absent at a given altitude, it means:

- the system has not received data for the altitude, or
- the data is expired

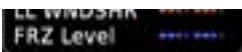

**FIS-B Weather:** To view freezing altitude, select the freezing level G-AIRMET. Updates occur four times daily.

# Icing



**AVAILABLE WITH:**  
**FIS-B | SIRIUSXM**



## NOTE

*Due to the incremental and overlapping nature of the FIS broadcast, timestamps, regional coverage, and map data availability may vary with altitude for computer generated FIS-B icing forecasts.*



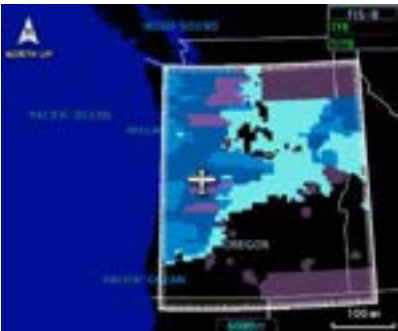



FIS-B Icing



Icing potential provides a graphic view of current icing conditions. SLD threat areas are depicted as black and pink blocks over the icing colors.

Categories vary depending on the configured weather source.

## ICING CATEGORIES

	SLD Threat		Light
	Heavy		Trace <sup>†</sup>
	Moderate		No Coverage <sup>†</sup>

<sup>†</sup> FIS-B Weather only.

Icing potential is not a forecast, but a presentation of icing potential at the time of analysis. Supercooled Large Droplet (SLD) icing conditions are characterized by the presence of relatively large, super cooled water droplets indicative of freezing drizzle and freezing rain aloft.

Directional keys allow you to adjust the reporting altitude within product-specific limits.

	FIS-B	SIRIUSXM
<b>Timestamp shows:</b>	Valid time in UTC	Time of data compilation
<b>Altitude Range:</b>	2,000 to 24,000 ft (at 2,000 ft intervals)	1,000 ft 3,000 ft 6,000 ft 9,000 to 30,000 ft (at 3,000 ft intervals)

# Lightning



AVAILABLE WITH:  
FIS-B | SIRIUSXM | CONNEXT

SiriusXM Lightning



**SiriusXM Weather:**

A yellow cross icon indicates a strike event occurring within a two kilometer region. Strike location is an estimate of its center.

Unlike Stormscope, the icon does not change shape or color as data ages.

**Connex Weather:** Only cloud-to-ground strikes are reported through the Connex weather service.



**FIS-B Weather:** Lightning strikes display as a lightning bolt.

## METARs and TAFs



**AVAILABLE WITH:**  
**FIS-B | SIRIUSXM | CONNEXT**

METAR and TAF reports provide information on current and forecast conditions. Colored METAR flags display when a METAR reporting station is matched with a corresponding navigation database identifier.

When selected, the METAR is decoded and displayed above the original METAR text. METARs are provided only in areas covered by the currently loaded navigation database.

Tapping a METAR opens a detailed report.

### FIS-B METARs



## METAR SYMBOLS



### VFR

Ceiling greater than 3000 ft AGL and visibility greater than five miles.



### Marginal VFR

Ceiling 1000 to 3000 ft AGL and/or visibility three to five miles.



### IFR

Ceiling 500 to 1000 ft AGL and/or visibility one to three miles.



### Low IFR

Ceiling below 500 ft AGL and/or visibility less than one mile.



### Unknown

Ceiling and/or visibility data unavailable.

# PIREPs



**AVAILABLE WITH:  
FIS-B | SIRIUSXM | CONNEXT**

PIREPs are pilot-generated weather reports that may contain non-forecast adverse weather conditions, such as low in-flight visibility, icing conditions, wind shear, and turbulence.

*FIS-B PIREPs*



Selecting a PIREP displays a report.



## PIREP SYMBOLS



Routine (UA)



Urgent (UUA)



Route

PIREPs are issued as either Routine (UA) or Urgent (UUA). Tapping a PIREP symbol displays textual details.

## SIGMETs



**AVAILABLE WITH:  
FIS-B | SIRIUSXM | CONNEXT**

The SIGMET overlay draws the geographical boundaries of received SIGMETs on the dedicated weather page. Convective and non-convective SIGNificant METErological Information combine in a textual report and display graphically for the observed or forecast region.

*SiriusXM SIGMETs & AIRMETs*



Tapping a SIGMET opens a detailed report.

**SIGMET:**  
Report: CONVECTIVE SIGMET 36RWALID  
UNTIL 1955Z WAFROM 3055E YDC-40NW  
EPHDVLPG LINE TS 30 NM WIDE MOV  
FROM 25020KT. TOPS TO FL340.

## Surface Analysis



**AVAILABLE WITH: SIRIUSXM**

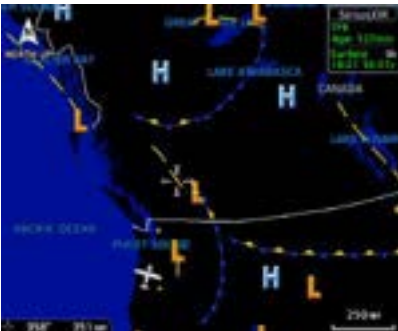

Displays weather fronts, high (H) and low (L) pressure centers, and isobars.

### Forecast Period Options:

- Current • 12 hour • 24 hour
- 36 hour • 48 hour

## TFRs



AVAILABLE WITH:  
FIS-B | SIRIUSXM | CONNEXT



### WARNING

**Do not exclusively use datalink services for TFR information. TFR Depictions may not be a complete listing and may vary between cockpit devices. Always confirm TFR information with official sources such as Flight Service Stations or Air Traffic Control.**

#### FEATURE LIMITATIONS

- TFRs that do not include geographical locations are not viewable on GTN

TFRs identify areas of airspace where aircraft are temporarily restricted from operating. They are routinely issued for occurrences such as dignitary visits, military activities, and forest fires.

Tapping a TFR displays textual details.

FIS-B TFRs



**FIS-B Weather:** TFR data updates every 20 minutes.

# Turbulence

**AVAILABLE WITH:**  
**FIS-B | SIRIUSXM**



## NOTE

*Due to the incremental and overlapping nature of the FIS broadcast, timestamps, regional coverage, and map data availability may vary with altitude for FIS-B turbulence forecasts.*

FIS-B Turbulence

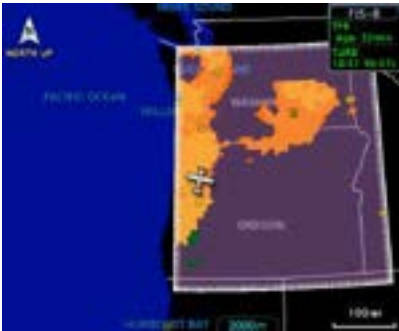

Turbulence data identifies the potential for erratic movement of high-altitude air mass associated winds. This information is intended to supplement AIRMETs and SIGMETs.

Turbulence is classified as light, moderate, severe or extreme.

Directional keys allow you to adjust the reporting altitude within product-specific limits.

	FIS-B	SIRIUSXM
<b>Timestamp shows:</b>	Valid time in UTC	Time of data compilation
<b>Altitude Range:</b>	2,000 to 24,000 ft (at 2,000 ft intervals)	21,000 to 45,000 ft (at 3,000 ft intervals)

# Winds Aloft



**AVAILABLE WITH:  
FIS-B | SIRIUSXM | CONNEXT**

*SiriusXM Winds Aloft*

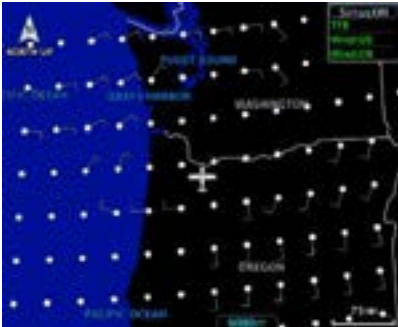

Indicates wind speed and direction, and temperature forecast for the specified altitude.

The wind barb extends outward from the reporting location dot in the direction of wind origination.

Directional keys allow you to adjust the reporting altitude within product-specific limits. Reporting altitudes vary depending on the weather provider.

**Altitude Range:**

FIS-B	SIRIUSXM	CONNEXT
1,000 ft 1,500 ft 3,000 to 53,000 ft (at 3,000 ft intervals)	Surface to 42,000 ft (at 3,000 ft intervals)	Surface to 42,000 ft (at 3,000 ft intervals)

## FIS-B WINDS & TEMPERATURES ALOFT

*FIS-B Winds & Temps Aloft*



FIS-B wind forecasts also provide temperature data for the selected altitude. These forecasts update every 12 hours.

Not all altitudes provide winds and temperatures aloft forecasts for all regions.

# SiriusXM Weather



SiriusXM satellites deliver high bandwidth (S-band) data to provide high-resolution images. Available data is received within a few minutes after the aircraft satellite receiver comes into view of the SiriusXM satellite network.

### FEATURE REQUIREMENTS

- SiriusXM receiver (GDL 69 or GDL 69A)
- Active SiriusXM Aviation Weather subscription

### FEATURE LIMITATIONS

- For Icing Potential, Winds Aloft (U.S.), and Turbulence, the valid time displays instead of product age
- For Freezing Level and Winds Aloft (Canada), the generation time displays instead of valid time

## Activating SiriusXM Services

Before you can access SiriusXM Weather, you must contact SiriusXM customer service and provide them with either one or two coded IDs:

- Data Radio ID (Weather)
- Audio Radio ID (Entertainment).

These coded IDs are used to send an activation signal, which allows the use of weather and entertainment products received by the GDL 69/69A.

### When SiriusXM weather services are not activated:

- All weather product boxes are cleared on the GDL 69 Status page
- A yellow "Activation Required" message appears at the center of the page

*Service Class* refers to the groupings of weather products available for subscription.

**SiriusXM Customer Service:**  
<https://www.siriusxm.com/sxmaviation>.

## COMPLETE SUBSCRIPTION ACTIVATION

1. Contact SiriusXM using the customer service telephone number listed on the website.
2. Provide the customer service agent with your Data Radio ID and Audio Radio ID.
3. Position aircraft within the satellite reception area and power on the unit.
4. Navigate to the GDL 69 Status page.
  - *From the Home page:* Tap **System** > **External LRUs**, locate GDL 69 and tap **More Info**.
  - *From the Music page:* Tap **Status**.
5. Verify activation. For weather subscriptions, the status page displays your Data Radio ID, Subscription Level, and a list of weather products.
6. Tap **Menu** > **Lock Activation** > **OK**.

### Troubleshooting the GDL 69/69A Datalink Receiver

GTN serves as the control head for your remotely mounted GDL 69/69A. In the event of a receiver failure:

- View datalink receiver status on the GDL 69 Status page
- Verify the SiriusXM Satellite Radio subscription is active
- Check circuit breakers to ensure power is applied to the receiver

It may take several minutes for all subscription data to become available after unit power up.

For more information, consult *GDL 69/69A SiriusXM Satellite Radio Activation Instructions*. For subscription activation instructions, visit <https://www.siriusxm.com/sxmaviation>.

# SiriusXM Weather Setup

## SiriusXM Weather Menu

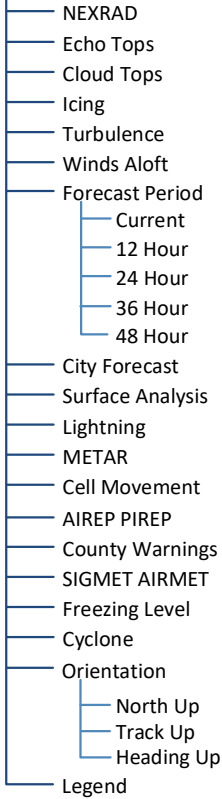

Tap **Menu** to access weather product overlay controls and pilot settings. Changes to an overlay setting take effect immediately.

- Enable/disable weather overlays
- Specify a forecast period
- Change the orientation of the weather display
- Display the product legend

### Map WX Overlays

SiriusXM Weather overlay controls reside in the Map Setup menu.

From the Home page, tap **Map > Menu, Map Setup**, and select the **Weather** tab.

If another weather source is active, tap **Weather Source** and select **SiriusXM**.

# FIS-B Weather



FIS-B weather data displays on the dedicated weather page and as overlays on Map. No pilot action is required to receive FIS-B weather information.

## FEATURE REQUIREMENTS

- UAT receiver (GDL 88 or GTX 345)

The FAA provides FIS-B as a Surveillance and Broadcast Service operating on the UAT (978 MHz) frequency band. FIS-B uses a network of FAA-operated ground-based transceivers to transmit weather datalink information to the aircraft's receiver on a scheduled continuous basis.

The Flight Information Service-Broadcast (FIS-B) Weather service is freely available for aircraft equipped with a capable datalink universal access transceiver (UAT). Ground stations provide uninterrupted services for the majority of the contiguous U.S., Hawaii, Guam, Puerto Rico, and parts of Alaska. No weather subscription service is required. For the latest FAA ground station coverage information, visit: [www.faa.gov/nextgen/programs/adsb/](http://www.faa.gov/nextgen/programs/adsb/)

## Data Transmission Limitations

FIS-B broadcasts provide weather data in a repeating cycle which may take several minutes to completely transmit all available weather data. Therefore, not all weather data may be immediately present upon initial FIS-B signal acquisition.

## LINE OF SIGHT RECEPTION

To receive FIS-B weather information, the aircraft's datalink receiver must be within range and line-of-sight of an operating ground-based transceiver. Reception may be affected by altitude, terrain, and other factors. Per the FAA, much of the United States has FIS-B In airborne coverage at and above 3,000 feet AGL. Terminal coverage is available at altitudes below 3,000 feet AGL and is available when flying near approximately 235 major U.S. airports. Surface coverage allows FIS-B ground reception at approximately 36 major U.S. airports.

### PER FAA TSO-C157B

FIS-B information may be used for pilot planning decisions focused on updating the pilot's awareness of the dynamic flight environment; including avoiding areas of inclement weather that are beyond visual range and pilot near-term decisions where poor visibility precludes visual acquisition of inclement weather. FIS-B weather and NAS status information may be used as follows:

- a. To promote pilot awareness of ownship location with respect to reported weather, including hazardous meteorological conditions; NAS status indicators to enhance pilot planning decisions; and pilot near-term decision-making.
- b. To cue the pilot to communicate with Air Traffic Control, Flight Service Station specialist, operator dispatch, or airline operations control center for general and mission critical meteorological information, NAS status conditions, or both. FIS-B information, including weather information, NOTAMs, and TFR areas, are intended for the sole purpose of assisting in long-/near-term planning and decision making. The system lacks sufficient resolution and updating capability necessary for aerial maneuvering associated with immediate decisions. In extreme scenarios, the oldest weather radar data on the display can be up to 15 to 20 minutes older than the display's age indication for that weather radar data. Therefore, do not attempt to use FIS-B weather information to maneuver the aircraft at minimum safe distances from hazardous weather. FIS-B information must not be used in lieu of a standard preflight briefing.
- c. FIS-B uplink is a subscription-free FIS broadcast managed by FAA SBS. It provides an FAA approved source for METAR, TAF, WINDS, PIREPs, NEXRAD, AIRMET, SIGMET, and TFR information, and is subject to the broadcast range limits for these products. FIS-B uplink is not an FAA approved source for NOTAMs.

### NOTAM 30-DAY LIMITATION

NOTAMs received via FIS-B may not be a complete listing. Active NOTAMs are removed from the FIS-B data stream 30 days after issuance. Before flight, review all necessary aeronautical and meteorological information from official sources.

For more information, consult AC 00-63A or latest revision.

## FIS-B Product Status



View the status of all FIS-B weather products. States include:

- Unavailable
- Awaiting Data
- Data Available

You may access this page one of two ways.

### From the External LRUs list:

Home > **System** > **External LRUs**, locate GDL 88 or GTX 345, and tap **More Info**

### From the FIS-B Weather menu:

Home > **Weather** > **FIS-B Weather** > **Menu** > **Datalink Status**

## FIS-B WEATHER ENABLED



To mitigate any possibility of the avionics receiving unexpected data formats in the FIS broadcast, you may disable FIS-B Weather by toggling the **Enabled** key to off.

This key is active by default. It is not intended for use under normal broadcast conditions.

# FIS-B Weather Setup

## FIS-B Weather Menu

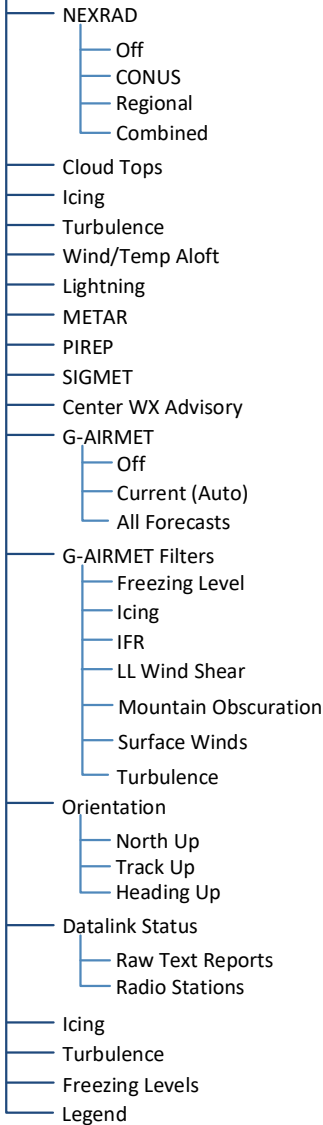

Tap **Menu** to access weather product overlay controls and pilot settings. Changes to an overlay setting take effect immediately.

- Enable/disable weather overlays
- Select a NEXRAD source
- Filter G-AIRMETs and specify a forecast period
- Change the orientation of the weather display
- View datalink status and enable/disable the FIS-B Weather function
- Display the product legend

The Datalink Status page provides controls for enabling/disabling the FIS-B Weather function, viewing raw text reports, and checking ground reception status.

### Map WX Overlays

FIS-B Weather overlay controls reside in the Map Setup menu.

From the Home page, tap **Map > Menu > Map Setup**, and select the Weather tab.

If another weather source is active, tap **Weather Source** and select **FIS-B**.

# Raw Text Reports

## Product Selections

- CWA
- METAR
- NOTAM
- PIREP
- SIGMET
- TAF
- Winds/Temps Aloft
- UNAVAIL FIS-B Products

View raw textual data for a FIS-B product.

1. Open the FIS-B WX Status page.
2. Tap **Raw Text Reports**.
3. Select a weather product.

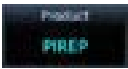

The latest uploaded data for the product displays on a dedicated page.

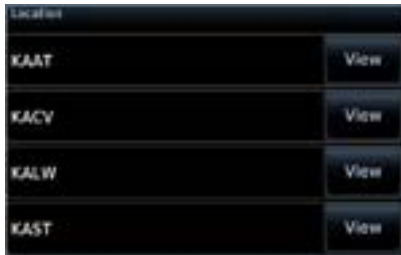

Multiple reporting stations appear in a list. Tapping **View** displays raw text for the corresponding identifier.



To view information about products not available due to a service outage, select **Unavailable Products**.

## READING WINDS/TEMPS ALOFT REPORTS

Tapping **Winds/Temps Aloft** displays a forecast of winds and temperatures for different altitudes. Temperature forecasts are not included for altitudes below 2,500 ft AGL.

On the raw text report, altitude values do not align with the corresponding forecast. Match the color of the altitude and forecast to interpret the information.

*Color markings are for reference only.*

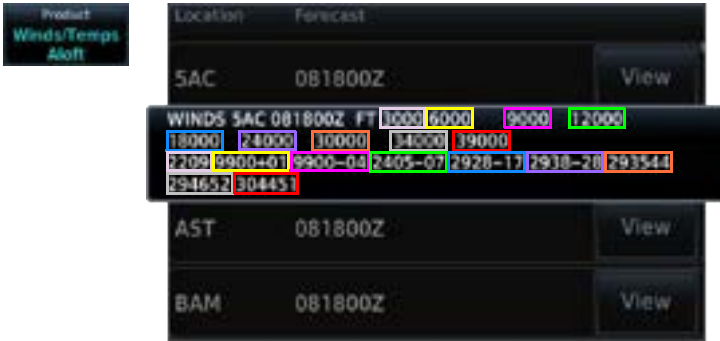

### ALTITUDE (FT)

3,000	6,000	9,000	12,000	18,000	24,000	30,000	34,000	39,000
2209	9900+01	9900-04	2405-07	2928-17	2938-28	293544	294652	304451

## FIS-B Ground Reception Status



Monitor FIS-B ground station transmission status from the FIS-B Reception Status page.



Current Report List shows the completeness of NOTAM-TFR, AIRMET, and SIGMET data for all received ground stations.

Station Range field indicates complete/incomplete status for only the products within the received ground station's range.

### OPEN FIS-B RECEPTION STATUS PAGE

#### Datalink Weather Menu

- Raw Text Reports
- Radio Stations

This page is accessible from the Datalink Weather menu. You can access this menu one of two ways:

#### From FIS-B Weather:

Tap **Menu > Datalink Status > Menu > Radio Stations**.

#### From the External LRU list:

Home > **System > External LRUs > Locate GDL 88 and tap More Info > Datalink Status > Menu > Radio Stations**.

# Connex Weather



Garmin provides Connex datalink, on-demand weather products through the Iridium satellite system via a GSR 56 transceiver and L-band frequencies. An Iridium satellite data subscription service is required for worldwide Connex weather coverage.

### FEATURE REQUIREMENTS

- GSR 56 transceiver
- Active Connex subscription

Connex Weather coverage is available throughout most of Europe, Canada, and the U.S. Additional radar coverage areas are added continuously. Various world-wide weather subscription package options provide weather reporting for most of Europe, Canada, Australia, and the U.S.

For the latest radar coverage information, visit:

<https://fly.garmin.com/fly-garmin/connex/worldwide-weather/>

## Activate Connex Satellite Services

To access Connex Weather, visit [flyGarmin.com](https://fly.garmin.com) and create a Connex Satellite Services account. Garmin will issue an access code for entry in the Connex Registration pop-up.

When completing your application for Connex Satellite Services, be ready to provide the following information.

- GTN ID
- Iridium serial number
- Airframe info:
  - Model
  - Tail number
  - Serial number



If access code and system ID are correct, the airframe registration details will display.

Current  
Registration  
Detail

### To complete activation:

1. Move aircraft within satellite range and power on the unit.
2. Tap **Weather > Connex Weather > Menu > Connex Settings > Datalink Status > Connex Registration > Access Code**.
3. Enter the required code, then tap **Register**.

## Deactivate Connex Unit Registration

You can deactivate your registration by entering an invalid access code in the Connex Registration pop-up window. This prevents the unit from making any further requests from Connex. Requests made after deactivation will fail.

### From the GSR Status page:

1. Tap **Connex Registration > Access Code**.
2. Tap **CLR** to remove the current access code.
3. Enter an invalid code, then tap **Register**.

Deactivating your Connex registration does not cancel your subscription.

# Connex Weather Setup

## Connex Weather Menu

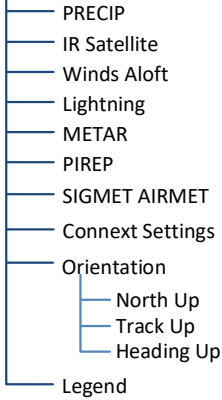

Tap **Menu** to access weather product overlay controls and pilot settings. Changes to an overlay setting take effect immediately.

- Enable/disable weather overlays
- View Iridium satellite datalink status and signal strength
- Change the orientation of the weather display
- Display the product legend

Tap **Connex Settings** to access the Data Request function and various coverage region options. From here you may access the GSR Status page, where the Connex Registration function resides.

## Connex Settings Menu

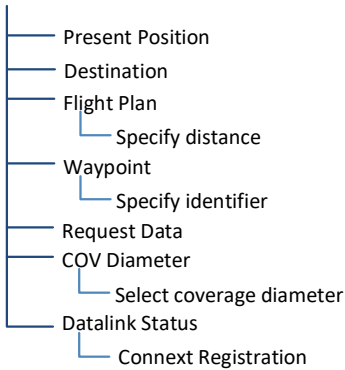

### Map WX Overlays

Connex Weather overlay controls reside in the Map Setup menu.

From the Home page, tap **Map > Menu > Map Setup**, and select the Weather tab.

If another weather source is active, tap **Weather Source** and select **Connex**.

## Connext Data Requests

### FEATURE REQUIREMENTS

- *Direct connection to GSR 56 (Auto Request function)*

Download selected weather products for a specific waypoint, flight plan, destination, or your current position. A request must be sent in order for downloading to occur.

### WHERE TO FIND IT

#### Connext Weather Menu

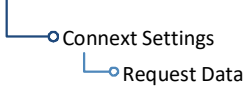

Weather data request controls reside in the Connext Settings menu.

Requests may be sent manually or set to occur automatically within a specified time interval.

## DATA REQUEST CONTROLS



### Request Data

Request weather data at any time regardless of predetermined automatic update frequency.

Once the request is sent, you may reset the Auto Request timer (if active) for the next request interval.



### Auto Request

Select a weather request period to enable automatic updates.

Options: • Off • 5 min • 10 min



A timer counts down to the next update. The **Cancel Request** key becomes available.

### Multiple Weather Requests

To accommodate multiple weather requests, Connext merges the following products with stale data, while discarding the stale data of other products.

- AIRMETS
- METARs
- SIGMETs
- TAFs
- TFRs

Use these controls when you want to:

- *Set automatic updates:*  
Tap **Auto Request** and select the automatic weather request period.
- *Request a manual update:*  
Tap **Menu** > **Connext Settings** > **Request Data**.
- *Cancel a request in progress:*  
Tap **Cancel Request**.

### COVERAGE REGION OPTIONS

<b>Present Position</b>	Request weather information around aircraft's present position. COV diameter determines extent of request.
<b>Destination</b>	Request weather information for the destination airport.
<b>Flight Plan</b>	Request weather information for the active flight plan route.
<b>Distance</b>	Enter requested weather information for a specified distance along the active flight plan. Range: 10 nm to 500 nm
<b>Waypoint</b>	Request weather information for a specified waypoint.
<b>COV Diameter</b>	Define the diameter of coverage. Range: 10 nm to 500 nm

### GTN 650Xi SERIES



Coverage region controls reside in a dedicated submenu.

Tap **Menu > Connex Settings > Coverage Region**.

# Stormscope



Stormscope lightning information displays on a dedicated weather page and as overlays on Map.



## WARNING

***Do not exclusively use the lightning detection system for weather avoidance. the system may display inaccurate or incomplete information. refer to the lightning detection system documentation for additional information.***

### FEATURE REQUIREMENTS

- WX-500 Stormscope Weather Mapping Sensor

### FEATURE LIMITATIONS

- Stormscope lightning information cannot display concurrently with any datalink weather product (SiriusXM, Connex, or FIS-B)

## Stormscope Features

- Passive weather avoidance system
- Detects electrical discharges from thunderstorms within 200 nm of current position
- Plots strike count and relative bearing location every two seconds
- Heading and distance from aircraft
- Arc and 360° viewing options

For more information, consult the WX-500 pilot's guide.

# Stormscope Setup

## Stormscope Menu

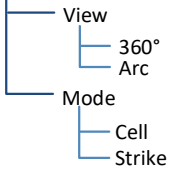

Tap **Menu** to access Stormscope setup options.

From here, you can change the current display view and mode settings.

Changes in mode selection also reflect on the associated Map overlay.

### Stormscope Map Overlay

Stormscope overlay controls reside in the Map menu.

From the Home page, tap **Map > Menu > Stormscope**.

Changes in overlay mode selection also reflect on the Stormscope display. The same is true for clearing strikes on Map.

## Stormscope Modes & Symbols

### Cell Mode

Identifies clusters of electrical activity, grouping individual strikes together.

#### When to use:

During heavy storm activity to identify where storm cells are located.

### Strike Mode

Displays individual discharge points in relation to where they are detected.

#### When to use:

During periods of light electrical activity to plot the initial strikes associated with a building thunderstorm.



Less than 6 strikes (initial strike)



Less than 60 strikes



Less than 120 strikes



Less than 180 strikes

## Strike Rate

Strike Rate reports the approximate number of strikes per minute for a given view range. Refer here when trying to determine if storm cells are building or decaying.

Mode: **Strike** | Rate: **41**

Strikes occur at a higher rate as a storm matures. They are less frequent as the storm dissipates.

## CLEAR STRIKES

Clear  
Strikes

Tapping this key resets the rate value and clears the display of all strikes. Clearing strikes on the Stormscope display also clears them on Map.

Stormscope data displays with or without a heading source. If flying without a heading source, you must clear all strikes following each heading change

## Views

Stormscope provides both arc and 360° views of lightning data.

## ARC VIEW



Cell Mode



Strike Mode

### 360° VIEW

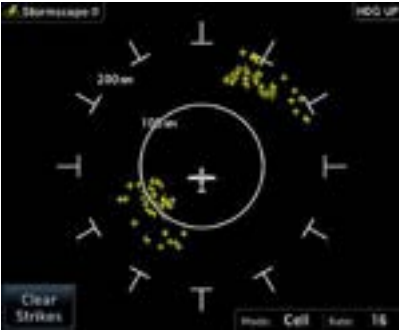

Cell Mode



Strike Mode

#### Stormscope Display Orientation

Heading Up is the normal display orientation. If no heading source is available, the page orientation label changes to "HDG N/A."

# Airborne Weather Radar

**AVAILABLE WITH:  
GTN 750Xi SERIES**



Weather radar information displays on a dedicated weather page and as overlays on Map.



## WARNING

*Use weather radar to avoid severe weather, not to enter it.*

### FEATURE REQUIREMENTS

- GTN 725Xi or GTN 750Xi

### FEATURE LIMITATIONS

- Available modes and intensity levels depend on the installed radar type
- Not available on GTN 650Xi Series units

## Maximum Permissible Exposure Level, GWX 68

Radiation exceeds the U.S. Government standard level of  $1 \text{ mW/cm}^2$  11 feet from the antenna. All personnel must a minimum safe distance while the radar is in operation.

Average power density at the MPEL boundary significantly reduces with a scanning or rotating beam.

For information on safe distance determination, refer to Advisory Circular 20-68B.

For maximum permissible exposure levels, consult the appropriate radar documentation.

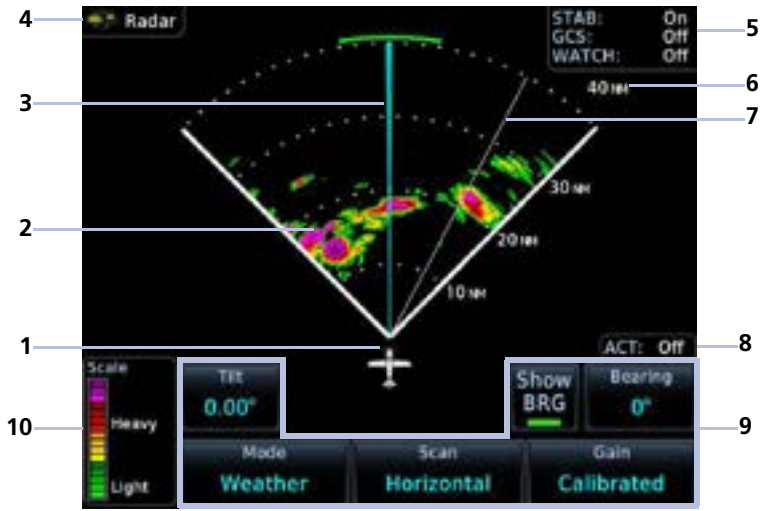

**Weather Radar Features**

1	Aircraft Symbol	6	Radar Display Range
2	Weather Depiction	7	Scan
3	Bearing/Tilt Line	8	ACT Status Field
4	WX App Label	9	Radar Controls
5	Feature Status Display	10	Intensity Scale

## RADAR UNITS



Distance units on the radar display are determined by the pilot selectable Distance/Speed setting on the System Units page (Home > **System** > **Units** > **Distance/Speed**).

## DISPLAY ADJUSTMENTS



Tapping **In** and **Out** changes the radar display range.

## TILT AND BEARING ADJUSTMENTS

To adjust tilt and bearing angle, tap and drag the line indicator as necessary, or use the associated control keys.

## INTENSITY SCALE



**Weather**

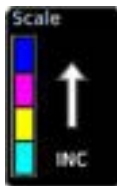

**Ground**

Each operating mode uses a unique color palette to depict increasing intensity levels.

## WARM-UP COUNTDOWN TIMER



A warm-up period initiates upon power up (GWX 68 only). Duration varies depending on how long the radar is off. The radar begins transmitting once warm-up is complete.

# Weather Radar Setup

## Weather Radar Menu

- Turbulence Detection [1][2]
- Ground Clutter Suppression [1][2]
- Altitude Compensated Tilt [2]
- WATCH Shading [3]
- Stabilization
- Weather Messages [3]
- Sector Scan [3]
  - Select scan width

[1] Requires feature enablement.  
[2] GWX 70/75/80 only.  
[3] Not available for third-party radars.

Tap **Menu** to access weather radar setup options. Available features are dependent upon configuration. With the exception of Sector Scan, all selections are on/off only.

**Map WX Overlays**  
The Radar overlay control resides in the Map Setup menu. From the Home page, tap **Map > Menu > Radar**. Radar and NEXRAD overlays are mutually exclusive. Selecting one automatically turns the other off.

## ALTITUDE COMPENSATED TILT

**AVAILABLE WITH:  
GWX 70/75/80**

### FEATURE LIMITATIONS

- *Not available for third party radars*



This feature adjusts the tilt to compensate for altitude changes as the aircraft climbs and descends. Status displays above the radar controls.

## GROUND CLUTTER SUPPRESSION

**AVAILABLE WITH:  
GWX 70/75/80**

### FEATURE REQUIREMENTS

- Purchased GWX Ground Clutter Suppression feature enabled on unit

### FEATURE LIMITATIONS

- Not available for third party radars
- Horizontal scans only

This feature reduces the amount of returns of highly reflective objects on the ground, while maintaining the intensity and size of weather returns.

## SECTOR SCAN

### FEATURE LIMITATIONS

- Not available for third party radars
- Horizontal scans only

The sector scan option focuses the scan on a smaller segment of the radar sweep. This is useful when monitoring priority weather targets.

GWX	INCREMENTS
68	20°, 40°, 60°, Full
70/75/80	20°, 40°, 60°, 90°, Full
The 90° horizontal scan option is available only for radars with extended scan capabilities (120° sweep).	

Horizontal sector scans center on the bearing line.

Increments vary according to radar.

## STABILIZATION

This feature helps stabilize the antenna so the scan is parallel to the ground when active. When off, the antenna scan is relative to the aircraft lateral axis.

## TURBULENCE DETECTION

**AVAILABLE WITH:  
GWX 70/75/80**

### FEATURE REQUIREMENTS

- Purchased GWX Turbulence Detection feature enabled on unit

### FEATURE LIMITATIONS

- Not available for third party radars
- Horizontal scans only

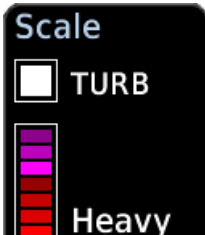

This feature detects and displays severe turbulence. A legend shows when turbulence detection is active. Status reports as inactive when:

- Current scan range is greater than 160 nm
- Radar is not in weather mode
- Vertical scan is active

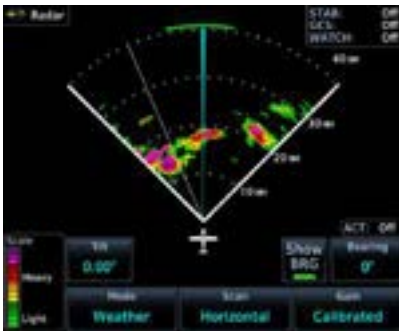

**Turbulence Off**

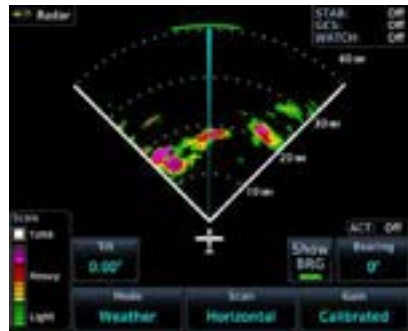

**Turbulence On**

The decision to fly into an area of radar targets depends on target intensity, spacing between targets, aircraft capabilities, and pilot experience.

Some weather radars detect only precipitation, not clouds or turbulence. While GTN may indicate clear areas between intense returns, this does not mean it is safe to fly between them.

## WATCH

### FEATURE LIMITATIONS

- Not available for third party radars
- Horizontal scans only

Use WATCH to determine areas of inaccuracies in displayed intensity from attenuation while in horizontal scan mode. Adjust tilt to determine the extent of attenuation in a shaded area. WATCH displays only in horizontal scans.

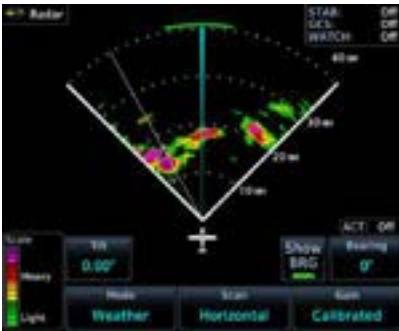

**WATCH Off**

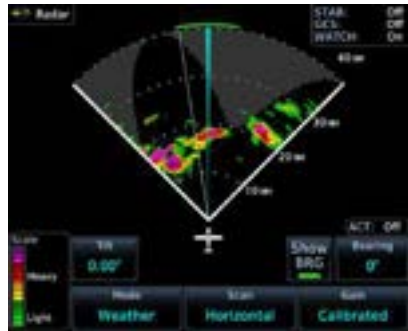

**WATCH On**

## WEATHER MESSAGES

### FEATURE LIMITATIONS

- Not available for third party radars
- Not available during ground mode
- Horizontal scans only

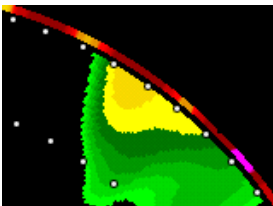

These alerts indicate the presence of heavy precipitation beyond the current display range (80 nm to 320 nm from current position).

Red bands on the outer range ring display at the approximate azimuth of severe weather targets.

- If the antenna tilt is adjusted too low, a weather alert is generated by ground returns.
- If a weather alert is detected within +10 degrees of the aircraft heading, an advisory displays in the message list.

## Radar Modes



### WARNING

*Do not transmit when personnel or objects are within 11 feet of the antenna.*



Tapping **Mode** opens a list of available mode options.



A confirmation pop-up alerts the pilot when attempting to scan while on the ground.

## STANDBY



- Parks the antenna at the centerline
- Automatic standby occurs during power up and landing

During weather and ground modes, the system automatically switches to standby upon landing.

## TEST

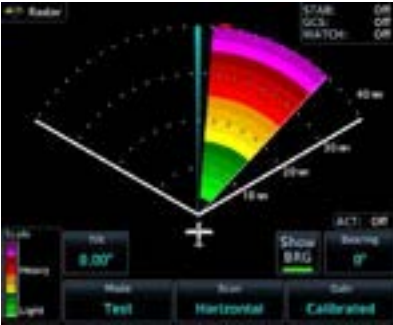

- Places transmitter in standby as the display simulates a radar sweep
- Data verifies communication between the weather radar and display
- Radar pulses do not transmit from the antenna during this mode

## GROUND

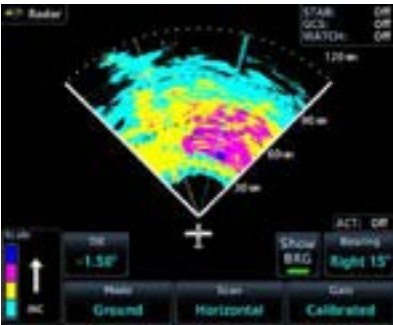

- Presents a depiction of terrain similar to that of a topographical map
- Useful when trying to verify aircraft position

GROUND MAP MODE COLOR	GROUND TARGET INTENSITY LEVELS	
	GWX RADAR INTENSITY	THIRD-PARTY RADAR LEVEL
Black	0 dB	0
Light Blue	> 0 dBZ to < 9 dBZ	1
Yellow	9 dBZ to < 18 dBZ	2
Magenta	18 dBZ to < 27 dBZ	3 and above
Blue	27 dBZ and greater	Not used

**WEATHER**

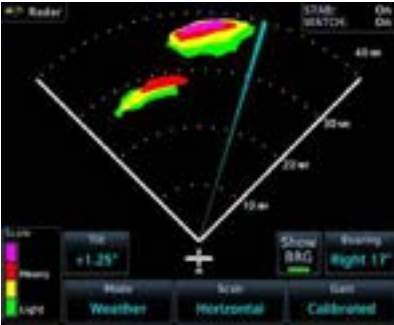

**GWX 68 Radar**

- Presents an airborne depiction of precipitation
- Colors represent approximate rainfall intensity and rates for weather radar targets

WEATHER MODE COLOR	GWX 68 RADAR		GWX 70 RADAR	THIRD-PARTY RADAR
	APPROXIMATE INTENSITY	APPROXIMATE RAINFALL RATE (IN/HR)	APPROXIMATE INTENSITY	RADAR RETURN LEVEL [1]
Black	< 23 dBZ	< .01	< 23 dBZ	0
Green	23 dBZ to < 33 dBZ	.01 - 0.1	23 dBZ to < 33 dBZ	1
Yellow	33 dBZ to < 41 dBZ	0.1 - 0.5	33 dBZ to < 41 dBZ	2
Red	41 dBZ to < 49 dBZ	0.5 - 2	41 dBZ to < 49 dBZ	3
Magenta	49 dBZ and greater	2	49 dBZ and greater	4
White			Turbulence Detection	

[1] Refer to radar documentation.

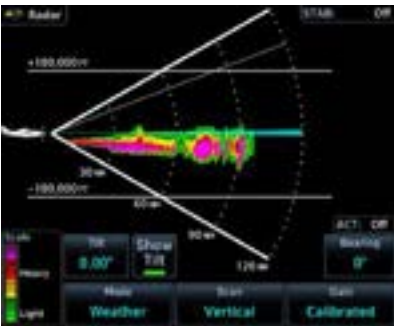

**GWX 75 Radar**

WEATHER MODE COLOR	GWX 75/80 RADAR
	APPROXIMATE INTENSITY
Black	< 22 dBZ
Green	23 dBZ to < 32 dBZ
Yellow	33 dBZ to < 40 dBZ
Red	41 dBZ to < 48 dBZ
Magenta	49 dBZ and greater
White	Turbulence Detection

# Radar Controls

## Weather Radar Page

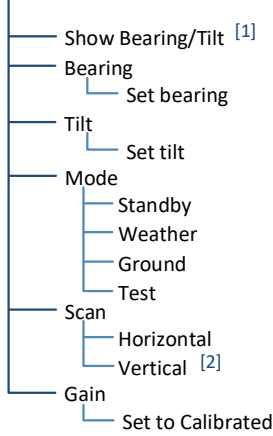

- [1] Dependent on scan type selection.
- [2] Not available for RS 181 and RS 811 radars.

Some radars allow independent sweeps when connected to multiple displays.

GWX 68 synchronizes the controls from all connected displays. All other GWX radars receive commands from each display independently and perform a separate sweep for each.

## SHOW BEARING/TILT

Display the tilt or bearing line depending on the current scan selection. This feature is useful when making horizontal or vertical scan adjustments.

### Horizontal Scan Active



### Vertical Scan Active



## BEARING

### FEATURE LIMITATIONS

- Bearing angle not available on RS 181A and RS 811A radars



Bearing Direction & Value

Directional keys allow fine adjustment of the bearing line angle. This method is optional to tapping and dragging.

### TILT

Use antenna tilt to locate the top and bottom of storm cells and to increase intensity of ground target returns. One degree of tilt equals 100 feet of altitude per nautical mile.

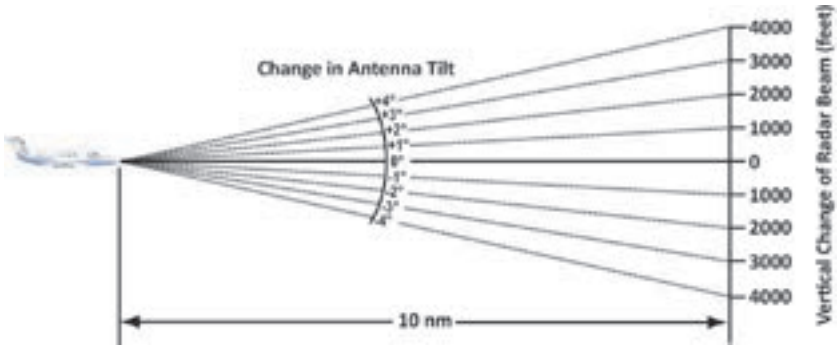

### Basic Antenna Tilt Setup



In a typical tilt setup, the bottom of the radar beam is adjusted to 4° below parallel with the ground. To achieve this:

1. Fly the aircraft level.
2. Adjust antenna tilt so ground returns display at a distance equal to the aircraft's current altitude (AGL) divided by 1,000.

Remember the following points when flying with the antenna at this basic angle setting.

#### Altitudes between 2,000 and 30,000 ft AGL:

- Avoid target returns at 5 nm. These may be either weather or ground returns that are 2,000 ft or less below the aircraft.
- Raise the antenna tilt 4° to separate ground returns from weather returns in flat terrain. Return the antenna to the previous setting after a few sweeps of the radar.
- Set the display range to 60 nm for aircraft flying at 15,000 ft or lower. Monitor ground returns for possible threats.

#### Altitudes above 29,000 ft:

Be cautious of targets 30 nm or closer. This may indicate a thunderstorm that the aircraft cannot fly over safely.

For a more accurate view of target coverage and intensity, center the tilt angle on the strongest return area, aiming below the freezing level of the storm.

In areas of multiple heavy cells, use the vertical scan feature along with antenna tilt to examine the cells. Avoid shadowed areas behind targets.

## VERTICAL SCAN

### FEATURE LIMITATIONS

- Vertical scan not available on RS 181A and RS 811A radars

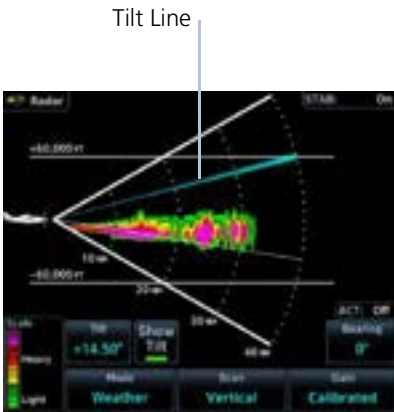

Vertical scans focus the radar on a particular vertical target.

- *Enable tilt line visibility:* Tap **Show Tilt**.
- *Adjust tilt of vertical scan:* Tap and drag tilt line up or down. Or tap **Tilt** and adjust angle using the directional keys.
- *Adjust horizontal angle for the vertical scan:* Tap **Bearing** and adjust angle using the directional keys.

### Vertical Scan with Stabilization

When vertically scanning with stabilization on, the physical area that the radar is sweeping may not match the displayed vertical scan. This occurs when the aircraft pitch is not at 0°. To compensate, the GDU does not draw the unscanned portion.

To avoid constant adjustment of the bearing line, ensure that the aircraft wings are level when performing a vertical scan of a storm cell.

### HORIZONTAL SCAN

Horizontal scans provide a visual depiction of weather in front of the aircraft.

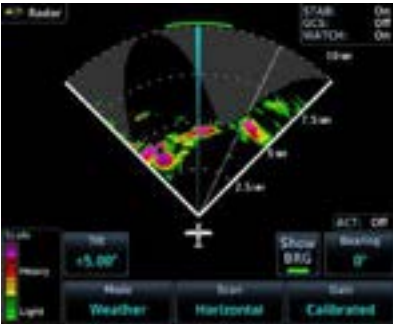

- *Enable bearing line visibility:* Tap **Show BRG**.
- *Adjust the horizontal scan bearing:* Tap and drag bearing line left or right. Or tap **Bearing** and adjust angle using the directional keys.
- *Adjust vertical angle for the horizontal scan:* Tap **Tilt** and adjust angle using the directional keys.

### GAIN



#### NOTE

*Precipitation intensity may not be accurate if the gain is changed.*

#### FEATURE LIMITATIONS

- *For third party radars, this control is active only during ground mode*

This feature controls the sensitivity of the radar receiver. Adjustments to receiver sensitivity automatically change the intensity of radar targets.

Directional keys allow sensitivity adjustments.



Default  
Calibration  
Setting

Tapping **Set to Calibrated** restores the calibrated gain setting and returns intensity depictions to their actual colors.

## Radar Alerts



Caution messages alert you when there is a weather radar failure. For a list of possible radar alerts, refer to the annunciations table in this segment.



### Radar Alert Annunciation

#### When a radar alert occurs:

- A textual annunciation appears over the radar sweep
- Scan depictions do not display
- Weather radar overlay detail is absent from Map if heading input is lost

**ALERT ANNUNCIATIONS**

ANNUNCIATION	ALERT TYPE   CONDITION
<p><b>Radar Fault</b></p>	<p><b>Alert Type:</b> Caution  <b>Condition:</b>                      Data contains a fault unrelated to attitude.</p>
<p><b>Radar Fail</b></p>	<p><b>Alert Type:</b> Caution  <b>Condition:</b>                      Weather radar product status is timed out.</p>
<p><b>Radar Controls Disagree</b></p>	<p><b>Alert Type:</b> Caution (Third-party radars only)  <b>Condition:</b>                      Radar’s actual state does not match the commanded state.</p>
<p><b>Radar Active</b></p>	<p><b>Alert Type:</b> Caution  <b>Condition:</b>                      Radar is in standby, but remains active due to another interfacing controller.</p>
<p><b>Off</b></p>	<p><b>Alert Type:</b> Advisory (GWX only)  <b>Condition:</b>                      Radar is off.</p>
<p><b>Warm Up XX</b></p>	<p><b>Alert Type:</b> Advisory (GWX 68 only)  <b>Condition:</b>                      Radar is warming up. Countdown timer displays number of seconds remaining (“XX”).</p>
<p><b>Standby</b></p>	<p><b>Alert Type:</b> Advisory  <b>Condition:</b>                      Radar is in standby mode.</p>

# Traffic Awareness



## WARNING

**DO NOT RELY SOLELY UPON THE DISPLAY OF TRAFFIC INFORMATION FOR COLLISION AVOIDANCE MANEUVERING. THE TRAFFIC DISPLAY DOES NOT PROVIDE COLLISION AVOIDANCE RESOLUTION ADVISORIES AND DOES NOT UNDER ANY CIRCUMSTANCES OR CONDITIONS RELIEVE THE PILOT'S RESPONSIBILITY TO SEE AND AVOID OTHER AIRCRAFT.**

### FEATURE LIMITATIONS

- *Traffic symbols vary according to traffic source (e.g., TIS-A, TAS, ADS-B)*
- *Intruding aircraft without altitude reporting capabilities do not display altitude separation data or climb /descent indications*
- *Available display ranges and vector types are dependent upon traffic source*

### Available Traffic Sources

- TIS-A
- TCAD 9900B
- TCAD 9900BX
- Ryan TCAD 9900BX w/GDL 88
- TAS/TCAS I
- TCAS II
- ADS-B

The availability of functions, alerting features, and options depend on the traffic system source.

ADS-B controls are accessible from the Traffic setup menu. Controls for other traffic systems reside in a control menu and/or on the Traffic page.

# Traffic Display



Collision avoidance and traffic surveillance data display on the dedicated Traffic page and as overlays on Map.

The Traffic page displays intruding traffic in relation to the current position and altitude of the aircraft without clutter from other data.



## WARNING

**DO NOT RELY SOLELY UPON THE DISPLAY OF TRAFFIC INFORMATION TO ACCURATELY DEPICT ALL OF THE TRAFFIC WITHIN RANGE OF THE AIRCRAFT. DUE TO LACK OF EQUIPMENT, POOR SIGNAL RECEPTION, AND/OR INACCURATE INFORMATION FROM AIRCRAFT OR GROUND STATIONS, TRAFFIC MAY BE PRESENT THAT IS NOT REPRESENTED ON THE DISPLAY.**

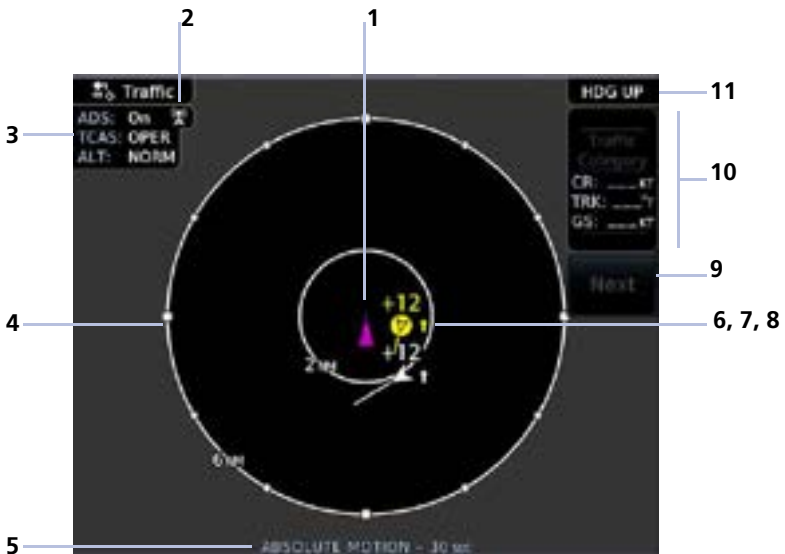

Traffic Display Features

<p><b>1</b></p>	<p><b>Ownship Icon</b>                  Depicts current aircraft position.</p> <ul style="list-style-type: none"> <li>• Nose of the ownship is the actual ownship location</li> <li>• Unlike the configured aircraft symbol on map displays, ownship icon is always a directional arrow</li> </ul>
<p><b>2</b></p>	<p><b>Ground Station Transmitter Status Icon</b></p>

3	<p><b>Traffic Status &amp; Active Applications</b></p> <ul style="list-style-type: none"> <li>• Status indications: <ul style="list-style-type: none"> <li>• <b>On</b> means the AIRB and ATAS traffic applications are active</li> <li>• <b>Off</b> means that air and ground applications are inactive</li> <li>• <b>Test</b> means the traffic test function is active</li> <li>• <b>Fail</b> means that ADS-B reports a failure</li> </ul> </li> <li>• <b>+SURF</b> means that ground targets displays in addition to airborne targets</li> <li>• Altitude filter setting (NORM, ABV, BLW, UNR)</li> </ul>
4	<p><b>Range Ring</b></p> <ul style="list-style-type: none"> <li>• Outer ring represents selected range</li> <li>• Range options vary according to traffic application</li> </ul>
5	<p><b>Selected Vector Type and Duration</b></p> <p>Types: Absolute and Relative Refer to Motion Vector for more information.</p>
6	<p><b>Intruding Aircraft Symbol</b></p> <p>Actual intruder location varies according to symbol type.</p> <ul style="list-style-type: none"> <li>• Tip of directional symbols</li> <li>• Center of non-directional symbols</li> </ul>
7	<p><b>Altitude Separation Value</b></p> <p>Indicates when an intruder is above or below the ownship.</p> <ul style="list-style-type: none"> <li>• Value appears above or below the traffic symbol, depending on relative altitude</li> <li>• Plus or minus sign denotes higher or lower altitude in hundreds of feet</li> </ul>
8	<p><b>Vertical Trend Arrow</b></p> <p>Active when an intruder is climbing or descending at a vertical speed greater than 500 fpm.</p>
9	<p><b>Next Key</b></p> <p>Available when multiple targets are spaced closely together.</p>
10	<p><b>Selected Traffic Information Window</b></p> <p>Select and view aircraft information for multiple traffic symbols. Refer to Traffic Interactions for more information.</p>
11	<p><b>Page Orientation Label</b></p> <ul style="list-style-type: none"> <li>• <b>Track Up</b> orients page to current aircraft GPS track</li> <li>• <b>Heading Up</b> orients page to current aircraft heading (requires heading data source interface)</li> </ul>

## GROUND STATION TRANSMITTER STATUS ICON



TIS-B ground station transmitter is providing a traffic picture specific to the ownship aircraft.



Traffic picture may be incomplete in the vicinity of the ownship. A partial traffic picture may be available due to:

- aircraft-to-aircraft ADS-B and/or
- traffic pictures from the ground station customized for other nearby aircraft

## TRAFFIC UNITS

PARAMETER	UNITS
Altitude	ft
Distance	nm

Traffic units are always uniform. Selections on the System Units page do not affect the traffic display.

## TRAFFIC GROUPS

When the Traffic Grouping function is active, traffic within close proximity of each other may display as a group.



- Asterisk indicates that the target belongs to a group
- Relative proximity of the closest target determines color
- Depiction is of the most immediate threat

## OFF SCALE TRAFFIC ALERTS



Off scale (out of range) traffic alerts are depicted as half yellow symbols on the outermost range ring at the correct bearing.

**TRAFFIC OVERLAY STATUS ICON (MAP ONLY)**

This icon appears on map when the traffic overlay is active. It is absent when the overlay function is off.

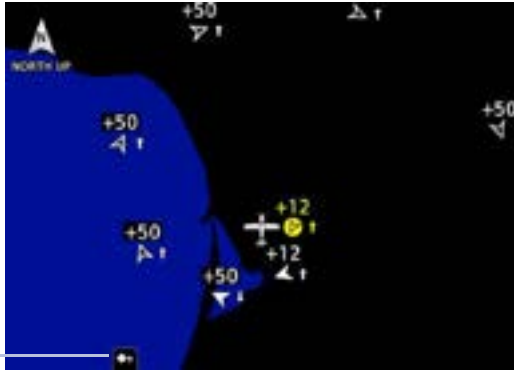

**Map Traffic Overlay**

An "X" appears over the icon when the overlay is on but unavailable.

# Traffic Setup

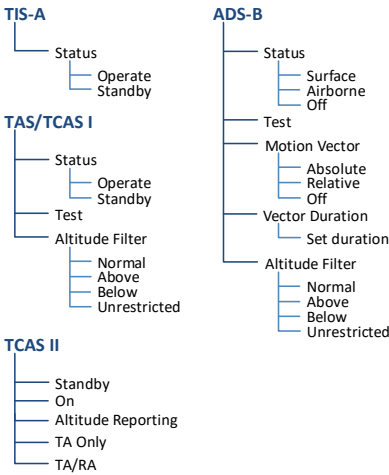

Tap **Menu** to access pilot selectable settings and the self-test functions.

**Map Traffic Overlay**  
 The overlay control resides in the Map setup menu.  
 Home > **Map** > **Menu** > Select **Traffic**.

## Traffic Test

### FEATURE LIMITATIONS

- ADS-B, TAS, and TCAS applications only
- Available only when the aircraft is on ground (i.e., standby mode)
- Test pattern depiction is dependent upon the active traffic system



The test function displays a test pattern on the Traffic page. For ADS-B, this option is accessible via the Traffic menu.

## Altitude Filtering

### FEATURE LIMITATIONS

- ADS-B, TAS, and TCAS applications only

Pilot selectable filters limit the display of traffic to a specific altitude range relative to the altitude of the ownship.

Filter selections apply to both the Traffic page and the traffic overlay on Map.

SELECTION	LABEL	ALTITUDE RANGE
Normal	NORM	-2,700 ft to 2,700 ft
Above	ABV	-2,700 ft to 9,900 ft
Below	BLW	-9,900 ft to 2,700 ft
Unrestricted	UNR	-9,900 ft to 9,900 ft

# Traffic Interactions

## Selected Traffic Information

- Registration/call sign
- Vehicle type
- Closure rate
- Track
- Ground speed

Selecting a traffic symbol displays information about the aircraft in the upper right corner of the page.

Selections remain active through altitude filtering, zoom scale, and page changes.



Tapping **Next** repeatedly steps through multiple symbols spaced closely together.



Selected Traffic Info

Next Key

Selected Traffic



When a traffic alert occurs, the Mute Alert option temporarily replaces the Next key.

# Traffic Types

## TIS-A



### NOTE

*Garmin is not responsible for Mode S geographical coverage. Operation of the ground stations is the responsibility of the FAA. Refer to the AIM for a Terminal Mode S Radar Site Map covering the U.S.*

#### FEATURE REQUIREMENTS

- Aircraft location is within the service volume of a Mode S terminal radar site
- TIS-capable Mode S transponder is interfaced to the GTN

#### FEATURE LIMITATIONS

- Except for GDL 88 or GTX 345 equipped aircraft, TIS and TAS may not both be displayed at the same time

TIS is available only when the aircraft is within the service volume of a TIS-capable terminal radar site. Aircraft without an operating transponder are invisible to both Traffic Advisory System (TAS) and TIS. Aircraft without altitude reporting capability are shown without altitude separation data or climb/descent indication.

TIS will be unavailable at low altitudes in many areas of the U.S., particularly in mountainous regions. Also, when flying near the “floor” of radar coverage in a particular area, intruders below the client aircraft may not be detected by TIS.

For information about TIS-A functions and limitations, consult the Aeronautical Information Manual (AIM).

### TIS-A Features

- 2-D graphical depiction of proximate traffic based on data received from terminal radars
- Track vector depicts intruder trajectory over the ground
- Vertical coverage: +3,500/ -3,000 ft from ownship
- Eight intruder maximum within an 8 nm radius
- Five second update cycle
- Normal and standby mode options

## TIS-A SETUP SELECTIONS

Select an operating mode: Tap **Status** and choose Operate or Standby.

## TIS-A TRAFFIC SYMBOLS

Traffic information is for advisory use only. The pilot is responsible for identifying and avoiding traffic.



Non-threat Traffic



Traffic Advisory (TA)



TA Off-scale

## TIS-A STATUS INDICATIONS

ANNUNCIATION	DESCRIPTION
Data Failed	GTN receives data from the transponder, but a failure exists in the data stream.
Failed	Transponder failure.
No Data	GTN is not receiving valid data from the transponder.
TA X.X NM $\pm$ XX $\updownarrow$	System cannot determine TA bearing. Intruder depiction not available. Annunciation includes: <ul style="list-style-type: none"> <li>• Distance in nautical miles</li> <li>• Altitude separation in hundreds of feet</li> <li>• Altitude trend arrow (climbing/descending)</li> </ul>
TA OFF SCALE	TA is outside the selected display range.
Traffic Coast x SEC	Intruder depictions are more than six seconds old.
Traffic Removed	Intruder depictions are more than 12 seconds old. Traffic symbols no longer display.
Unavailable	Transponder not receiving TIS-A data from ground station.

## TCAD 9900B

The Traffic and Collision Alert Device (TCAD) 9900B provides a passive system that uses transponder replies from other aircraft to acquire traffic information.

Ryan TCAD 9900B



IMMINENT TRAFFIC <sup>†</sup>	NON-IMMINENT TRAFFIC	
		Traffic Closing Vertically
		Traffic Diverging Vertically
		Traffic not Closing or Diverging Vertically

<sup>†</sup> Traffic within ±500 feet and 1.0 nm or no altitude and within 1.0 nm.

### TCAD 9900B PAGE SELECTIONS

- *Set local barometric pressure:* Tap **BARO** and specify a barometric pressure value.
- *Set the active shield:* Tap **Active Shield** and choose En route, Standard, or Terminal.

## TCAD 9900B MENU SELECTIONS

<b>Traffic Audio</b>	Set volume level of traffic alerts.
<b>Shield Setup</b>	Set the active shield. Options are Approach or Standard.
<b>Approach Mode</b>	Set the shield height.
<b>Shield Range</b>	Set the shield range.

## SHIELD SETUP

The Shield Setup function allows you to set the type (mode of operation) and volume of the shield that will provide alerts when entered by other aircraft.

### Set an approach shield:

1. Select En route, Standard, or Terminal
2. Ensure **Use DEST APT** is deselected and then tap **Field Elevation**.
3. Specify the field elevation value for traffic reporting.

Use DEST APT to automatically use the field elevation of the destination airport of the active flight plan for traffic reporting. If a destination airport is not present in the GTN system, the TCAD will not receive a field elevation and therefore not automatically enter approach mode.

### Set an En Route, Standard, or Terminal shield:

1. Tap **Shield Type** and select the preferred shield type.
2. Tap **Shield Height** and specify the shield height value.
3. Tap **Shield Range** and specify the shield range value.

### Select a mode:

- *Approach mode*: Toggle the **Approach** key to choose between Set, Armed, or Active.
- *Ground mode*: Toggle the **Ground** key on or off.

## TCAD 9900BX

The TCAD 9900BX provides an active system that interrogates other aircraft to acquire traffic information. System setup is identical to TCAD 9900B.

Ryan TCAD 9900BX



## TCAD 9900BX SYMBOLS



Traffic Advisory



Proximity Advisory (color may be configured as cyan)



Other Traffic (color may be configured as cyan)



Out-of-Range Traffic Advisory

## Ryan TCAD 9900BX with GDL 88

Ryan TCAD is a system that provides audio and visual alerts for traffic near your aircraft. The information from this system can be interfaced through GTN.

### Ryan TCAD Features

- TCAS-like symbols are used in the 9900BX
- Altitude modes are available (normal, look up, look down, unrestricted)
- Ranges are manually controlled for the current shield

### TRAFFIC DISPLAY RANGE

Options include: • 1 nm • 2 nm • 2 and 6 nm • 6 and 12 nm • 12 and 24 nm

### RYAN TCAD ALERT TYPES

The Ryan TCAD is an on-board air traffic display used to identify potential collision threats. TCAD computes relative altitude and range of threats from nearby Mode C and Mode S-equipped aircraft. TCAD will not detect aircraft without operating transponders or those that are beyond radar coverage. When within the defined limits, TCAD creates a *shield* of airspace around the aircraft that detected traffic cannot penetrate without triggering an alert.

- **TA:** Traffic Advisory. Traffic with 500 feet, or less, of altitude separation that is converging or maintaining altitude separation.
- **PA:** Proximity Advisory. Traffic with 500 feet of altitude separation that is not a TA.
- **TRFC:** Other traffic.

When a TCAD is connected to a GTX 345, the available controls will appear as described for TCAS. For details about the Ryan TCAD system, consult the associated pilot's guide.

Ryan TCAD with GDL 88



## TCAD SETUP SELECTIONS

Tapping **TCAD Control** provides access to setup controls for the TCAD Traffic display.

<b>Traffic Audio</b>	Sets volume level of traffic audio.
<b>Field Elevation</b>	Sets the elevation.
<b>BARO</b>	Sets the barometric pressure.
<b>Operate</b>	Toggles TCAD traffic on and off.
<b>Ground Mode</b>	Toggles TCAD ground mode on and off.
<b>Approach Mode</b>	Toggles TCAD approach mode on and off.

## TAS/TCAS I

### FEATURE LIMITATIONS

*Pilots should be aware of TAS limitations. TAS requires transponders of other aircraft to respond to system interrogations. If the transponders do not respond to interrogations due to phenomena such as antenna shading or marginal transponder performance, traffic may be displayed intermittently, or not at all.*

*Aircraft without altitude reporting capability are shown without altitude separation data or climb descent indication. Pilots should remain vigilant for traffic at all times.*

### TAS/TCAS I Features

- Airborne traffic system independent of ground radar
- 2-D graphical depiction of traffic relative to aircraft position and altitude

### TAS/TCAS I SETUP SELECTIONS

<b>Status</b>	Select operating mode. Options are Operate and Standby.
<b>Test</b>	Initiate a test of the traffic system.
	Select filter range. Options include:
<b>Altitude Filter</b>	<ul style="list-style-type: none"> <li>• Normal</li> <li>• Above</li> <li>• Below</li> <li>• Unrestricted</li> </ul>

### TAS/TCAS I TRAFFIC SYMBOLS

Traffic information is for advisory use only. The pilot is responsible for identifying and avoiding traffic conflict.



Other Traffic



Proximity Advisory



Traffic Advisory



TA Off-scale

**TAS/TCAS I STATUS INDICATIONS**

ANNUNCIATION	DESCRIPTION
Data Failed	GTN receives traffic data, but the TAS unit is reporting a failure.
Failed	Traffic data failure.
No Data	GTN is not receiving valid data from the TAS unit.
TA X.X NM ±XX ↕	<p>System cannot determine TA bearing. Intruder depiction not available. Annunciation includes:</p> <ul style="list-style-type: none"> <li>• Distance in nautical miles</li> <li>• Altitude separation in hundreds of feet</li> <li>• Altitude trend arrow (climbing/descending)</li> </ul>

## TCAS II

### FEATURE LIMITATIONS

- GTS 8000 or third-party TCAS II system

If the installed TCAS II traffic system is not a GTS 8000, refer to the applicable documentation for system-specific information.

### TCAS II Features

- Monitors nearby airspace for aircraft flying with operating transponders
- Issues TAs to assist in visual identification of traffic
- Issues RAs to provide recommended vertical guidance maneuvers to resolve traffic conflicts

### TCAS II STATUS INDICATIONS

SELECTION	TRAFFIC PAGE ANNUNCIATIONS
<b>TCAS II Self-Test Initiated (TEST)</b>	Test
<b>Traffic and Resolution Advisory (TA/RA)</b>	TA/RA
<b>Traffic Advisory Only</b>	TA Only
<b>TCAS II Standby</b>	STBY
<b>TCAS II Failed</b>	Fail

### TCAS II ALERTS

When the TCAS II unit issues a TA or RA, "TRAFFIC" appears in the annunciator bar of the GTN, flashes for 5 seconds and remains until no TAs or RAs are detected.

- RA "TRAFFIC" annunciations are white text with red backgrounds
- TA "TRAFFIC" annunciations are black text with yellow backgrounds
- If a TA and RA occur simultaneously, only the red and white RA "TRAFFIC" annunciation displays

If the GTN is not displaying the Traffic page, the system displays a traffic alert pop-up.

- During a TA event, the system issues a single "Traffic, Traffic" voice alert each time the system detects a new TA threat
- During an RA event, voice alert(s) provide vertical guidance to resolve the traffic conflict
  - The VSI displays a range of vertical speeds to fly to or avoid as applicable
  - Additional voice alerts occur if the RA status changes and when the aircraft is clear of the conflict

If the traffic system cannot determine the bearing of a traffic or RA, the alert displays as a traffic alert banner

**RA X.X ± XX <UP> OR <DN>**

### Warning Banner

- Displays when the system is unable to determine the bearing of an RA and extreme pilot vigilance is required
- Banner indicates distance in nm and altitude separation in hundreds of feet
- If altitude trend is available, the banner indicates altitude trend up <UP> for climbing and down <DN> for descending traffic

**TA X.X ± XX <UP> OR <DN>**

### Caution Banner

- Displays when the system is unable to determine the bearing of a TA and pilot vigilance is required
- Banner indicates distance in nm and altitude separation in hundreds of feet
- If altitude trend is available, the banner indicates altitude trend up <UP> for climbing and down <DN> for descending traffic

### TCAS II TRAFFIC SYMBOLS

Traffic information is for advisory use only. The pilot is responsible for identifying and avoiding traffic conflict. The TCAS II system categorizes detected traffic into four groups of increasing collision threat potential. Lowest threat is OT and the highest is RA.

**OT**

Other non-threatening traffic.

---

**PA**

Traffic is not currently a threat, but is within 6 nm and  $\pm 1,200$  feet of the own-aircraft altitude.

---

**TA**

Indicates traffic is within 20-48 seconds of a potential collision area.

---

**Off-scale TA**

Traffic is beyond the selected map range and the system displays a half-TA symbol at the edge of the map at the approximate relative bearing of the TA traffic. If TA traffic subsequently meets the criteria for an RA, the system issues an RA.

---

**RA**

Indicates traffic is within 15-35 seconds of a potential collision area.

---

**Off-scale RA**

If RA traffic is beyond the selected map range, the system displays a half-RA symbol at the edge of the map positioned at the approximate relative bearing to the RA traffic.

### TCAS II WITH ADS-B

**NOTE**

*Aircraft that are surveilled only by ADS-B will not trigger a TCAS resolution advisory.*

TCAS II interrogates Mode-S transponder data while automatically receiving ADS-B position and velocity information directly from a comparably equipped aircraft target. For preciseness, the system correlates between two data sources and the system displays the traffic information for the source determined to be the most accurate. Traffic that is not correlated (i.e., only detected by one system but not the other) is also displayed for the flight crew. This may occur, for example, if another aircraft is beyond the surveillance range of the TCAS II, but it is still receiving position and velocity information from other ADS-B equipped aircraft. The traffic correlation feature improves the accuracy of the traffic displayed, while reducing the occurrence of displaying a single target twice.

# ADS-B

## FEATURE REQUIREMENTS

- *GTN with external ADS-B In product (GDL 88, GTX 345, or GTS)*

## FEATURE LIMITATIONS

- *Available functions and alerting features are dependent upon the ADS-B traffic system source*

## ADS-B Features

















- Runway and taxiway depiction during SURF mode (< 2 nm range scale)
- Selectable traffic icons display intruder and vector information
- Customizable motion vectors (type, duration)
- Airborne and surface mode options
- On-scene mode option (rotorcraft only)

## ADS-B SETUP SELECTIONS

<b>ADS-B Status</b>	Enable automatic mode selection. System selects between Surface and Airborne depending on the state of the aircraft. Selecting Off disables the function.
<b>Test</b>	Initiate a test of the traffic system.
<b>Motion Vector</b>	Select motion vector type. Selecting Off removes all motion vectors from the display. <ul style="list-style-type: none"> <li>• Absolute</li> <li>• Relative</li> <li>• Off</li> </ul>
<b>Vector Duration</b>	Select the amount of time represented by the endpoint. Options range from 0 seconds to 5 minutes. A longer duration results in a longer vector.
<b>Altitude Filter</b>	Select filter range. Options include: <ul style="list-style-type: none"> <li>• Normal</li> <li>• Above</li> <li>• Below</li> <li>• Unrestricted</li> </ul>

## ADS-B TRAFFIC SYMBOLS

Traffic Information is for advisory use only. The pilot is responsible for identifying and avoiding traffic conflict.

	Basic Directional		Proximate Directional
	Basic Non-directional		Proximate Non-directional
	Basic Off-scale Selected		Proximate Off-scale Selected
	Directional (On-Ground)		Non-directional Alerted
	Non-directional (On-Ground)		Off-scale Non-directional Alerted Traffic
	Proximate Directional (On-Ground)		Directional Alerted Traffic
	Proximate Non-directional (On-Ground)		Off-scale Directional Alerted Traffic
	Directional Surface Vehicle		Non-directional Surface Vehicle

## ADS-B TRAFFIC APPLICATIONS

### FEATURE REQUIREMENTS

- Aviation database (SURF only)

### FEATURE LIMITATIONS

- ATAS does not alert to traffic on ground

ADS-B In traffic supports three applications:

**AIRB:** Basic Airborne Application

**ATAS:** ADS-B Traffic Advisory System

**SURF:** Surface Situation Awareness

AIRB is considered the fundamental airborne traffic application. ATAS provides alerts when airborne traffic trajectories pose a potential collision risk. SURF provides additional situational awareness when you are on ground or within the terminal environment.

### TRAFFIC APPLICATIONS

#### AIRB & ATAS

- Both active when ADS-B is “On” (airborne traffic indications are available; ATAS arms to provide airborne alerts)
- Alerts occur when potential collision risks are determined based on current airborne position and trajectory and the position and trajectories of other airborne traffic
- Airborne traffic alerts only (no alerts on ground or for traffic on the ground)
- Nominally allow 20 to 40 seconds for flight crew response
- Provide aural alerting when traffic alerts occur

#### SURF

- Active on ground or within the terminal environment (<5 nm and <1,500 ft above field elevation)
- Traffic on ground may display when SURF is active
- Runway and taxiway depictions when the zoom scale is <2 nm (Traffic page only)
- Depicts only traffic and ground vehicles equipped with ADS-B Out

### Traffic Application Failures

During normal operation, the “ADS: On” status annunciation means that both AIRB and ATAS applications are active. In the rare event of an application failure, it is possible that only one of the applications may be active. The unit provides indications to reflect which application is no longer operational.

- ADS field indicates “On”
- If AIRB is active and ATAS is failed, the unit displays the system message: “ADS-B traffic alerting function inoperative”
- If AIRB is failed and ATAS is active (and still capable of providing a no-bearing aural alert), “Unavailable” annunciates across the traffic display

## MOTION VECTORS

### FEATURE LIMITATIONS

- *Motion vectors display on the Traffic page only*

A motion vector is a line extending from the nose of an intruder icon. Its orientation represents the intruder’s direction and movement. A yellow vector indicates when traffic meets intruding TA criteria (i.e., closing rate, distance, vertical separation).

### MOTION VECTOR TYPES

- |                 |  |
|-----------------|--|
| <b>Absolute</b> | <ul style="list-style-type: none"><li>• Cyan or white vector depending on configuration</li><li>• Depicts intruder ground track</li><li>• Calculations based on intruder direction and ground speed</li><li>• Endpoint depicts intruder’s position over the ground at the end of the selected duration</li><li>• Airborne and ground functionality</li></ul>   |
| <b>Relative</b> | <ul style="list-style-type: none"><li>• Green vector</li><li>• Depicts intruder movement relative to the ownship</li><li>• Calculations based on track and ground speed of both intruder and ownship</li><li>• Endpoint depicts intruder’s location relative to the ownship at the end of the selected duration</li><li>• Airborne functionality only</li><li>• “Relative Motion - Unavailable” annunciates during ground operations</li></ul> |

## ADS-B STATUS INDICATIONS

ANNUNCIATION	DESCRIPTION
Absolute Motion - XX SEC/MIN	Active motion vector type is absolute.
Failed	ADS data failure.
No Data	GTN is not receiving valid traffic data.
No GPS Position	ADS-B LRU detects that GPS unit is initializing.
Relative Motion - XX SEC/MIN	Active motion vector type is relative.
Relative Motion - UNAVAILABLE	Aircraft is not airborne and the active motion vector type is relative.
Unavailable	Necessary traffic data not available.

## ADS-B TRAFFIC INTERACTIONS

### Selected Traffic Information

- Registration/call sign
- Vehicle type
- Closure rate
- Track
- Ground speed
- AIRB/SURF eligibility

Selecting a traffic symbol displays information about the aircraft in the upper right corner of the page.

Selections remain active through altitude filtering, zoom scale, and page changes.

Tapping **Next** repeatedly steps through multiple symbols spaced closely together.

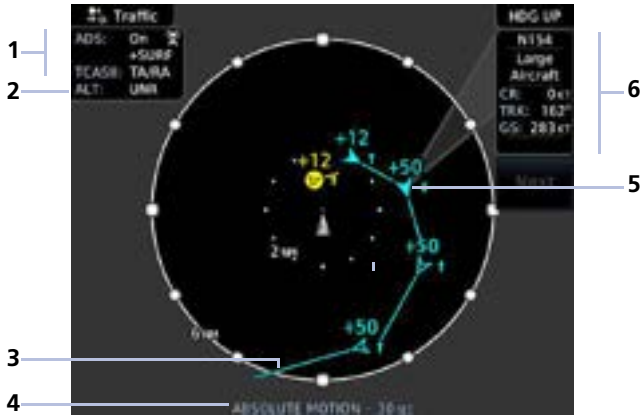

ADS-B Traffic Features

1	ADS-B/TCAS Status & AIRB/SURF Eligibility Indications	4	Selected Vector Type & Duration
2	Altitude Filter Setting Indication	5	Selected Traffic
3	Traffic Motion Vector	6	Selected Traffic Information

# Traffic Alerting

## Traffic Alert Types

- Textual annunciations at the bottom of the screen
- Color-coded target icons on Traffic page
- Pop-up window when another page is active

Traffic alerts occur anytime there is an increase in the number of traffic advisories. They remain active until the area is clear of all TAs.



GTN 750Xi Series



Traffic pop-ups do not display when the aircraft is on ground.

GTN 650Xi Series



Traffic Alert Pop-up

ANNUNCIATION	ALERT TYPE   POP-UP   CONDITION   VOICE MESSAGE
TRAFFIC	<p><b>Alert Type:</b> Caution</p> <p><b>Pop-up Alert:</b> Yes</p> <p><b>Condition:</b></p> <ul style="list-style-type: none"> <li>• Traffic reports a traffic advisory</li> </ul> <p><b>Voice Message:</b></p> <ul style="list-style-type: none"> <li>• Message content depends on current traffic system configuration</li> </ul>

## Mute Alert

To silence the active traffic alert voice message, tap **Mute Alert**.

This function is applicable only to the active aural alert (does not mute future alerts).

## Alerting Parameters

### Alerting Parameter Considerations

- Altitude separation and trend
- Angle
- Speed
- Closure rate of each aircraft (ownship and target)

Traffic alerting parameters consider several factors in order to allow you enough time to acquire the target and maneuver the aircraft away from conflicting traffic.

To minimize nuisance alerts, traffic alerting sensitivity is adaptive, based on altitude above ground level. No aural alerts are given below 500 ft.

# Terrain Awareness



## WARNING

***Do not use Terrain and obstacle data to navigate or maneuver around terrain. They are an aid to situational awareness only.***

### FEATURE REQUIREMENTS

All terrain functions require the following components to operate properly.

- Valid 3-D GPS position for terrain and obstacle data display
- Valid terrain/obstacle database

### FEATURE LIMITATIONS

- Alerting functions are dependent upon the configured terrain alerting options

## Terrain Configurations

### Available Terrain Modes

- (H)Terrain Proximity
- Terrain Alerting
- TAWS-B<sup>†</sup>
- TAWS-A<sup>†</sup>
- (H)Terrain Alerting
- HTAWS<sup>†</sup>

Terrain Proximity displays relative elevations on moving map depictions (Terrain page, Map). It does not provide visual alerts.

Terrain Alerting adds Forward Looking Terrain Alert (FLTA) and Premature Descent Alert (PDA) functions. These include visual alerts when the aircraft flies below an alerting threshold.

<sup>†</sup> Optional.

Terrain controls are accessible from the Terrain menu. Map overlay keys are accessible from the associated map menu.

# GPS Altitude for Terrain

### FEATURE REQUIREMENTS

GPS altitude is derived from satellite measurements. To acquire an accurate 3-D fix (latitude, longitude, altitude), a minimum of four operating satellites must be in view of the GPS receiver antenna.

The terrain system uses GPS altitude and position data to:

- Create a 2-D image of surrounding terrain and obstacles relative to the aircraft's position and altitude
- Calculate the aircraft's flight path in relation to surrounding terrain and obstacles
- Predict hazardous terrain conditions and issue alerts

## GSL ALTITUDE & INDICATED ALTITUDE

The unit converts GPS altitude data to GSL altitude (i.e., the geometric altitude relative to MSL) for use in terrain functions. All Terrain page depictions and elevation indications are in GSL.

Variations between GSL altitude and the aircraft's corrected barometric altitude (or indicated altitude) are common. As a result, Terrain page altitude data may differ from current altimeter readings. Both GSL altitude and indicated altitude represent height above MSL, but differ in accuracy and reliability.

### GSL Altitude

- Highly accurate and reliable geometric altitude source
- Does not require local altimeter settings to determine height above MSL
- Not subject to pressure and temperature variations
- Affected primarily by satellite geometry

### Indicated Altitude

- Barometric altitude source corrected for pressure variations
- Requires frequent altimeter setting adjustment to determine height above MSL
- Subject to local atmospheric conditions
- Affected by variations in pressure, temperature, and lapse rate

# Database Limitations



## NOTE

*Garmin cross-validates terrain and obstacle data in accordance with TSO-C151d. However, the information should never be considered all-inclusive. Database inaccuracies or omissions may exist.*

Terrain and obstacle data are not available when the aircraft is operating outside of the installed database coverage area.

Garmin obtains terrain and obstacle data from government sources and cannot independently verify the accuracy and completeness of the information. Pilots must familiarize themselves with the appropriate charts and other data for safe flight.

DATABASE	LIMITATION
<b>Terrain</b>	<ul style="list-style-type: none"> <li>• Not available north of 89° N latitude and south of 89° S latitude</li> </ul>
<b>Obstacle</b>	<ul style="list-style-type: none"> <li>• Coverage areas vary according to database type</li> <li>• Power line indications for the contiguous United States and small parts of Canada and Mexico</li> <li>• Regional definitions may change without notice</li> <li>• May not contain uncharted obstacles</li> <li>• May include power lines or only HOT lines depending on database type [1]</li> </ul>

[1] HOT lines are power lines that share location with other obstacles identified by the FAA.

# Terrain Display



Terrain, obstacle, and wire data display as overlays on the dedicated Terrain page and as overlays on Map.

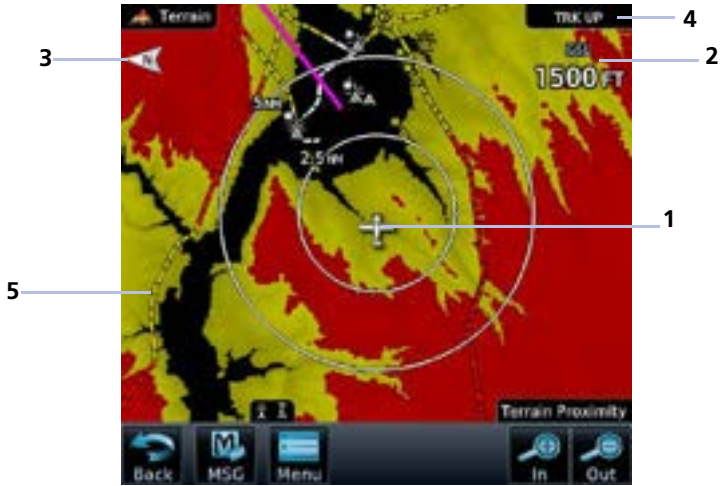

**Terrain Display Features**

1	<p><b>Ownship Icon</b> Depicts current aircraft position.</p>
2	<p><b>GSL Altitude</b> Displays current GPS height above mean sea level.</p>
3	<p><b>North Indicator</b> Indicates True north.</p>
4	<p><b>Page Orientation Label</b></p> <ul style="list-style-type: none"> <li>• <b>Track Up</b> orients page to current aircraft GPS track</li> <li>• <b>Heading Up</b> orients page to current aircraft heading (requires heading data source interface)</li> </ul> <p>Heading Up takes priority over Track Up when both orientation inputs are available.</p>
5	<p><b>Overlay Icons</b> Indicates power line or obstacle presence at the current zoom scale.</p>

## AUTOMATIC ZOOM



In the event an alert occurs, the page automatically zooms to provide the best depiction of that alerted terrain, obstacle, or power line.

## AUTOMATIC DATA REMOVAL



Automatic removal of obstacle and power line data occurs at range scales greater than 10 nm.

# Terrain Setup

## Terrain Page Menu

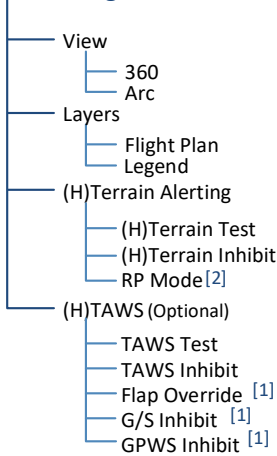

[1] TAWS-A only.

[2] Helicopter alerting functions only.

Tap **Menu** to access pilot selectable settings as well as self-test and alert inhibit functions.

### Map Terrain Overlays

Overlay controls reside in the Map setup menu.

Home > **Map** > **Menu** > Select from **Terrain** and **OBST/Wires**.

(H) designates the function is applicable to rotorcraft.

<b>View</b>	<b>360</b>	<ul style="list-style-type: none"> <li>Changes view format to a 360° ring encircling the aircraft (default view)</li> </ul>
	<b>Arc</b>	<ul style="list-style-type: none"> <li>Changes view format to a forward-looking 120° arc</li> </ul>
<b>Layers</b>	<b>Flight Plan</b>	<ul style="list-style-type: none"> <li>Toggles the active flight plan overlay on or off (Terrain page only)</li> </ul>
	<b>Legend</b>	<ul style="list-style-type: none"> <li>Toggles the Terrain and Obstacle/Wire legend on or off</li> </ul>
<b>HTAWS &amp; (H)Terrain Alerting</b>	<b>Test [NAME]</b>	<ul style="list-style-type: none"> <li>Performs a system test of the terrain alerting function</li> <li>Verifies the validity of required databases</li> </ul>
	<b>[NAME] Inhibit</b>	<ul style="list-style-type: none"> <li>Inhibits visual alerts for terrain, obstacles, and power lines</li> <li>Inhibits the FLTA aural and visual alerts</li> </ul>
	<b>RP Mode<sup>†</sup></b>	<ul style="list-style-type: none"> <li>Reduces alerting thresholds for low-level operations</li> </ul>

<b>TAWS-A</b>	<b>Flap Override</b>	<ul style="list-style-type: none"> <li>• Overrides flap-based FIT alerting while other FIT alert functions remain in effect</li> <li>• Inhibits nuisance FIT alerts where flap extension is not desired</li> </ul>
	<b>G/S Inhibit</b>	<ul style="list-style-type: none"> <li>• Inhibits glideslope or glidepath alerts depending on current state</li> <li>• Use to prevent glideslope/glidepath deviation alerts (e.g., when flying a localizer backcourse approach)</li> <li>• Active only for a single approach</li> </ul>
	<b>GPWS Inhibit</b>	<ul style="list-style-type: none"> <li>• Inhibits GPWS audible and visual alerts</li> <li>• (i.e., EDR, ECR, FIT, and NCR)</li> </ul>
<b>TAWS A &amp; B</b>	<b>TAWS Test</b>	<ul style="list-style-type: none"> <li>• Performs TAWS alerting system test</li> <li>• Verifies the validity of required databases</li> </ul>
	<b>TAWS Inhibit</b>	<ul style="list-style-type: none"> <li>• Inhibits the PDA/FLTA audible and visual alerts</li> </ul>

† Rotorcraft only.

# Terrain Proximity

## FEATURE LIMITATIONS

- Terrain and obstacle depictions are relative to aircraft altitude.
- Obstacle depictions are dependent upon database
- Does not provide visual or aural alerts

View color depictions of terrain and obstacle elevations relative to your current position and altitude.

## Terrain Proximity Features

- Non-TSO C151d certified terrain display system
- 2-D graphical representation of surrounding terrain, obstacles, and power lines relative to aircraft position and altitude
- Declutter automatically removes obstacle and power line data at large ranges
- Continuous monitoring of database validity, GPS and hardware status
- Displays when higher level terrain functions are active

## Terrain Elevation Depictions

Color shading depicts terrain elevations relative to the aircraft’s position and altitude. Colors automatically adjust as the aircraft’s altitude changes.

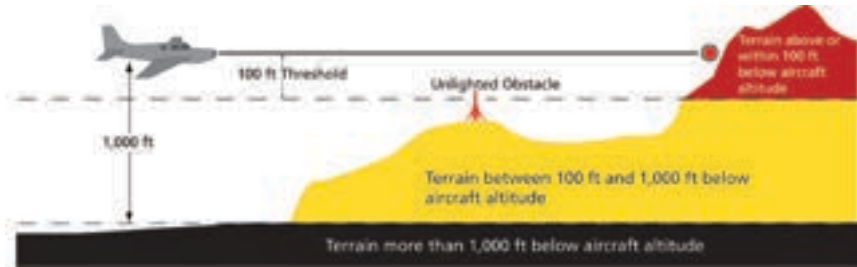

**Terrain Shading**

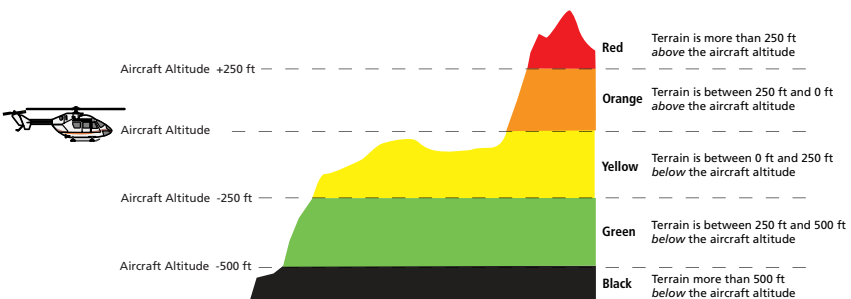













**Rotorcraft Terrain Shading**

# Obstacle Elevation Depictions







## FEATURE LIMITATIONS

- Obstacles more than 2,000 ft below current altitude do not display



## TOWER OBSTACLES

UNLIGHTED OBSTACLE		LIGHTED OBSTACLE		OBSTACLE LOCATION	
<1000' AGL	>1000' AGL	<1000' AGL	>1000' AGL	FIXED WING	ROTORCRAFT
				Red obstacle is above or within 100 ft below current altitude.	Red obstacle is at or above current altitude.
				Yellow obstacle is between 100 ft and 1000 ft below current altitude.	Yellow obstacle is within 250 ft below current altitude.
				White obstacle is between 1,000 ft and 2,000 ft below current altitude.	White obstacle more than 250 ft below current altitude.

## WIND TURBINE OBSTACLES

UNLIGHTED WIND TURBINE OBSTACLE	LIGHTED WIND TURBINE OBSTACLE	OBSTACLE LOCATION	
		FIXED WING	ROTORCRAFT
		Red obstacle is above or within 100 ft below current altitude.	Red obstacle is at or above current altitude.
		Yellow obstacle is between 100 ft and 1,000 ft below current altitude.	Yellow obstacle is within 250 ft below current altitude.
		White obstacle is more than 1,000 ft below current altitude.	White obstacle more than 250 ft below current altitude.

## POWER LINE OBSTACLES

OBSTACLE	POWER LINE OBSTACLE LOCATION
	Red power line is above or within 100 ft below current altitude.
	Yellow power line is between 100 ft and 1,000 ft below current altitude.
	White power line is between 1,000 ft and 2,000 ft below current altitude.

## OBSTACLE GROUPS



An asterisk indicates when the obstacle database contains only a single latitude and longitude for a group of obstacles. This occurrence is rare.

## Alert Types

The behavior of an alerting function is determined at installation. Installer configurable settings allow:

- Alert suppression for specific runway types
- Gender selection for voice messages
- Volume level

<b>TERRAIN ALERTING</b>
<ul style="list-style-type: none"> <li>• Imminent Impact</li> <li>• Reduced Clearance</li> <li>• Premature Descent</li> </ul>
<b>TAWS-A</b>
<ul style="list-style-type: none"> <li>• Imminent Impact</li> <li>• Reduced Clearance</li> <li>• Premature Descent</li> <li>• Excessive Descent Rate</li> <li>• Excessive Closure Rate</li> <li>• Negative Climb Rate</li> <li>• Flight Into Terrain</li> <li>• Excessive Below Glideslope/Glidepath Deviation</li> </ul>
<b>TAWS-B</b>
<ul style="list-style-type: none"> <li>• Imminent Impact</li> <li>• Reduced Clearance</li> <li>• Premature Descent</li> <li>• Excessive Descent Rate</li> <li>• Negative Climb Rate</li> </ul>

Available alerting functions depend on the installed terrain system.

ALERT TYPE	CONDITION
<b>Imminent Impact [1]</b>	Aircraft reaches the minimum clearance altitude of any obstacle (IOI), terrain (ITI), or power line (ILI) in the projected flight path.
<b>Reduced Clearance [1]</b>	Aircraft's vertical flight path is projected to be within the minimum clearance altitude of an obstacle (ROC), terrain (RTC), or power line (RLC).
<b>Premature Descent [2]</b>	Aircraft is significantly below the normal approach path for the nearest runway. <ul style="list-style-type: none"> <li>• Altitude is &lt;700 ft above terrain</li> <li>• Distance from destination airport is 15 nm or less</li> </ul>
<b>Excessive Descent Rate</b>	Aircraft descends toward terrain at an excessive rate.
<b>Excessive Closure Rate [3]</b>	Aircraft closes upon terrain at a rate excessive for gear and flaps in the landing configuration.
<b>Negative Climb Rate</b>	Aircraft loses altitude following takeoff. <ul style="list-style-type: none"> <li>• Altitude is &lt;700 ft above terrain</li> <li>• Distance from departure airport is 2 nm or less</li> <li>• Deviation from departure heading is &lt;110°</li> </ul>
<b>Flight Into Terrain</b>	Aircraft is too low with respect to terrain. Based on landing gear status, flap position, and ground speed.
<b>Excessive Below Glideslope or Glidepath Deviation</b>	Aircraft is significantly below the glidepath for the selected approach. Active only after departure and when the following conditions are met. <ul style="list-style-type: none"> <li>• Altitude is &lt;1,000 ft AGL</li> <li>• Gear is configured for landing</li> <li>• ILS, LPV, LNAV/VNAV, or LNAV+V approach is active and the unit is indicating vertical navigation</li> </ul>

- [1] Alerting inhibited <200 ft AGL within 0.5 nm of approach runway or <125 ft AGL within 1.0 nm of runway threshold.
- [2] Alerting inhibited within 0.5 nm of approach runway or <125 ft AGL within 1.0 nm of runway threshold. Alerting thresholds for final descent are based on current position, speed, and flight path data.
- [3] Alerting inhibited within 5 nm of nearest airport, except when FLTA is not available. In such cases, "TAWS N/A or TAWS FAIL annunciates and ECR alerting remains active until landing.

## Alerting Thresholds

FLIGHT PHASE	MINIMUM CLEARANCE ALTITUDE	
	LEVEL FLIGHT	DESCENDING
En Route	700 ft	500 ft
Terminal	350 ft	300 ft
Approach	150 ft	100 ft
Departure	100 ft	100 ft

## EDR THRESHOLDS

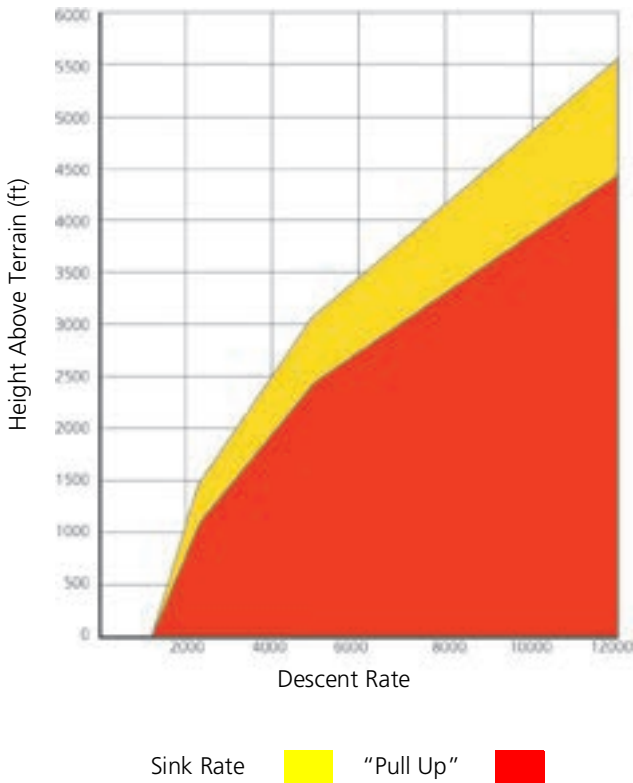

### PDA THRESHOLD

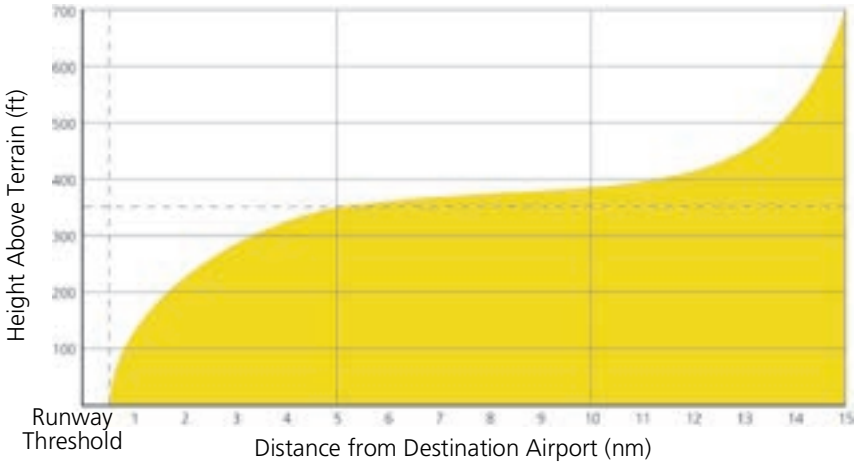

Alerting Area

### NCR THRESHOLDS

Alert triggers: altitude loss, sink rate

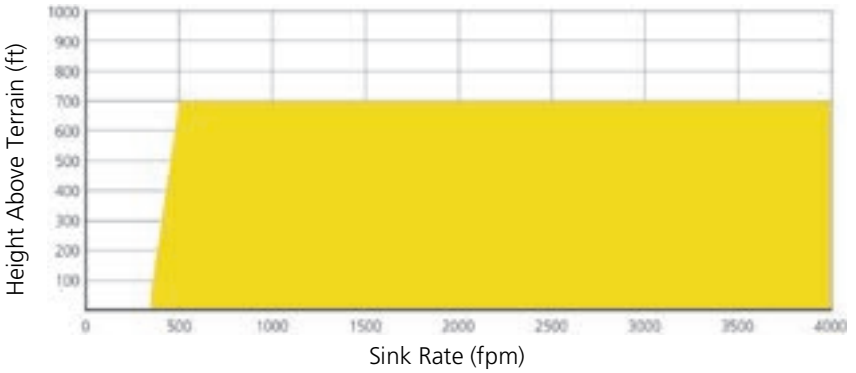

"Don't Sink"

### EXCESSIVE CLOSURE RATE ALERT

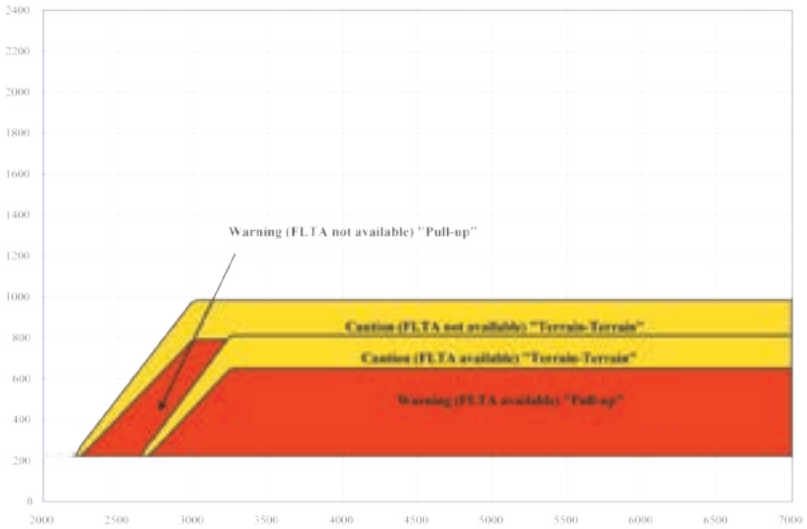
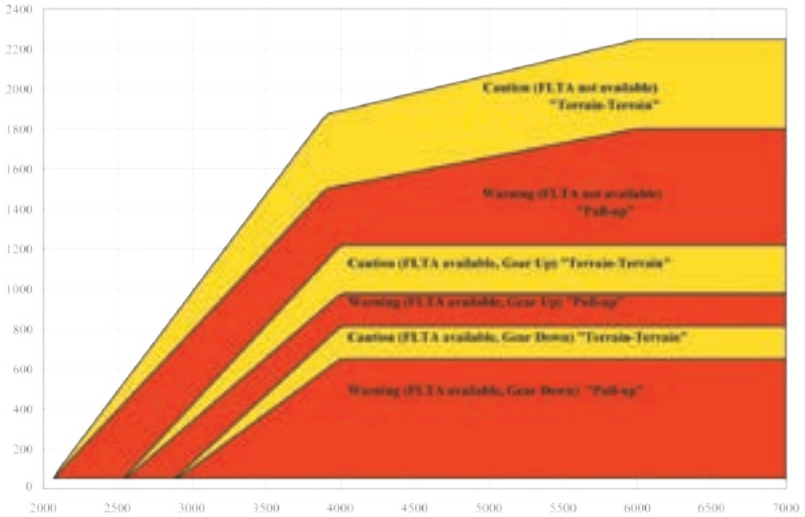

## FLIGHT INTO TERRAIN ALERT

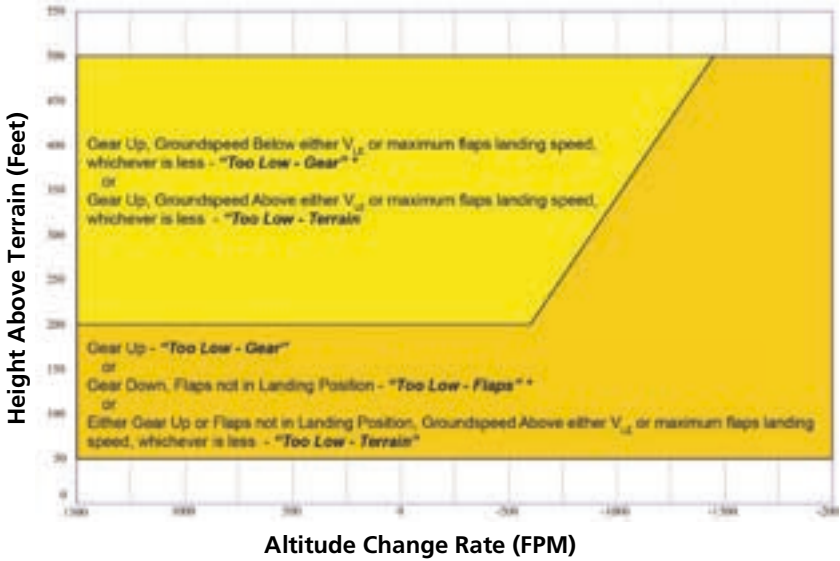

\* Flap position will not trigger alert if Flap Override option is enabled. To enable, tap **Menu > Flap Override**.

### OVERRIDING FLAPS-BASED FIT ALERTING

The FLAP O/R (Flap Override) should be activated when an approach without flaps is going to be performed.

To reduce nuisance FIT alerts on approaches where flap extension is not desired (or is intentionally delayed), the pilot may override FIT alerting based on the flap position, while all other FIT alerting remains in effect.

FIT alerts also occur during takeoff or go-around if the aircraft’s height above ground level (as determined by the radar altimeter) is too close to rising terrain. TAWS-A will issue the aural message “Too Low - Terrain” and visual annunciations when conditions enter the caution alert area.

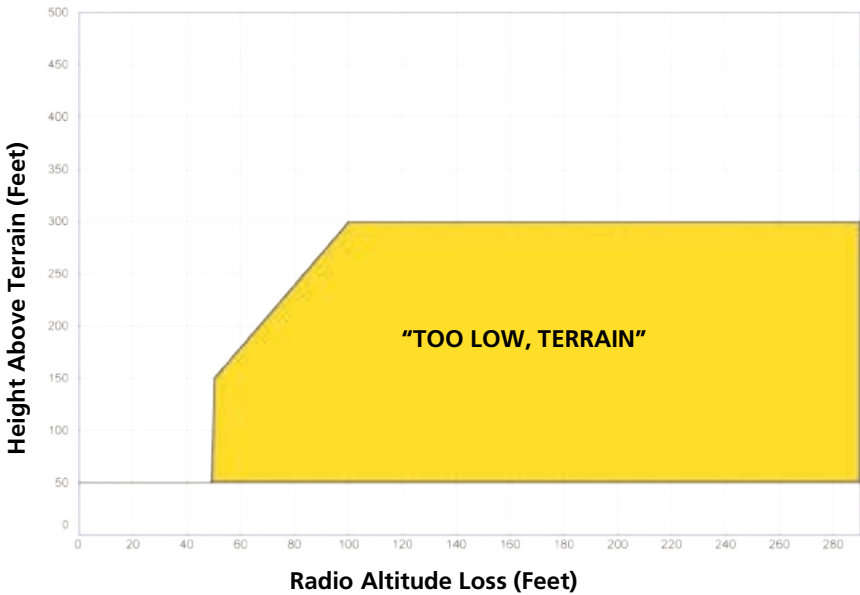

**EXCESSIVE BELOW GLIDESLOPE/GLIDEPATH DEVIATION ALERT**

A Glideslope Deviation or Glidepath Deviation (GSD) caution alert is issued when the system detects that the aircraft is significantly below the glideslope for the selected approach.

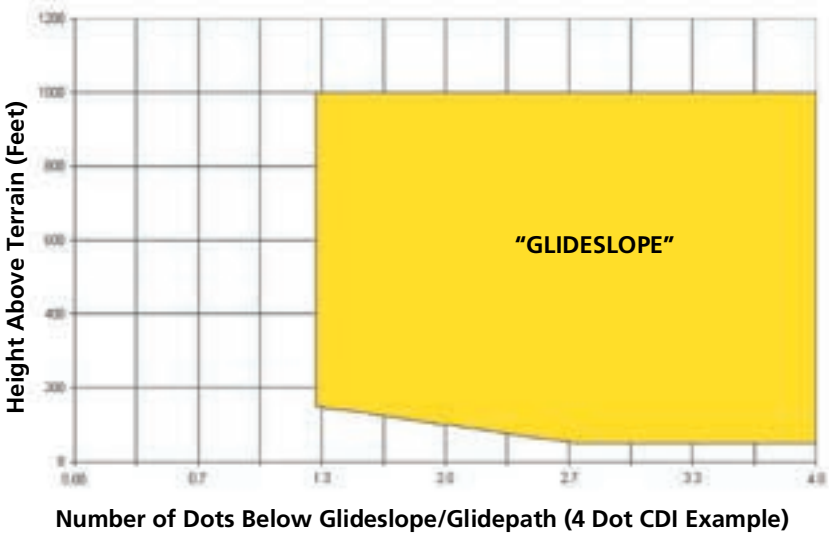

# Terrain Alerting

### FEATURE REQUIREMENTS

- *Valid terrain/obstacle database*
- *Valid 3-D GPS position solution*

Receive visual alerts for potential flight path conflicts involving terrain, obstacles, or power lines. Alerting behavior is determined at installation.

### Terrain Alerting Features

- Non-TSO C151d certified terrain alerting system
- FLTA functions: RTC, RLC, ROC, ITI, ILI, and IOI
- Premature Descent alerts
- Terrain depictions and display overlays
- Cautions and warnings indicate alert severity and threat type
- Textual annunciations
- Pop-up alerts
- Threat location indication on Terrain page and Map
- Self-test and alert inhibit functionality

TERRAIN ALERTING	
ANNUNCIATION	ALERT TYPE   CONDITION   AURAL MESSAGE
PULL UP	<p><b>Alert Type:</b> <b>Warning</b></p> <p><b>Condition:</b> FLTA Terrain Warning (RTC-W, ITI-W)</p> <p><b>Aural Messages:</b></p> <ul style="list-style-type: none"> <li>• "Terrain Ahead, Pull Up; Terrain Ahead, Pull Up"</li> </ul> <p><b>or</b></p> <ul style="list-style-type: none"> <li>• "Terrain, Terrain; Pull Up, Pull Up"</li> </ul>
	<p><b>Alert Type:</b> <b>Warning</b></p> <p><b>Condition:</b> FLTA Obstacle Warning (ROC-W, IOI-W)</p> <p><b>Aural Messages:</b></p> <ul style="list-style-type: none"> <li>• "Obstacle Ahead, Pull Up; Obstacle Ahead, Pull Up"</li> </ul> <p><b>or</b></p> <ul style="list-style-type: none"> <li>• "Obstacle, Obstacle; Pull Up, Pull Up"</li> </ul>
	<p><b>Alert Type:</b> <b>Warning</b></p> <p><b>Condition:</b> FLTA Wire Warning (ILI-W, RLC-W)</p> <p><b>Aural Messages:</b></p> <ul style="list-style-type: none"> <li>• "Wire Ahead Pull Up, Wire Ahead Pull Up"</li> </ul> <p><b>or</b></p> <ul style="list-style-type: none"> <li>• "Wire Wire, Pull Up, Pull Up"</li> </ul>
TERRAIN	<p><b>Alert Type:</b> <b>Caution</b></p> <p><b>Condition:</b> FLTA Terrain Caution (RTC-C, ITI-C)</p> <p><b>Aural Messages:</b></p> <ul style="list-style-type: none"> <li>• "Terrain Ahead; Terrain Ahead"</li> </ul> <p><b>or</b></p> <ul style="list-style-type: none"> <li>• "Caution, Terrain; Caution, Terrain"</li> </ul>
OBSTACLE	<p><b>Alert Type:</b> <b>Caution</b></p> <p><b>Condition:</b> FLTA Obstacle Caution (ROC-C, IOI-C)</p> <p><b>Aural Messages:</b></p> <ul style="list-style-type: none"> <li>• "Obstacle Ahead; Obstacle Ahead"</li> </ul> <p><b>or</b></p> <ul style="list-style-type: none"> <li>• "Caution, Obstacle; Caution, Obstacle"</li> </ul>

TERRAIN ALERTING	
ANNUNCIATION	ALERT TYPE   CONDITION   AURAL MESSAGE
WIRE	<p><b>Alert Type:</b> Caution</p> <p><b>Condition:</b> FLTA Wire Caution (ILI-C, RLC-C)</p> <p><b>Aural Messages:</b></p> <ul style="list-style-type: none"> <li>• “Wire Ahead, Wire Ahead”</li> </ul> <p><b>or</b></p> <ul style="list-style-type: none"> <li>• “Caution Wire, Caution Wire”</li> </ul>
TERRAIN	<p><b>Alert Type:</b> Caution</p> <p><b>Condition:</b> Premature Descent Alert Caution (PDA)</p> <p><b>Aural Messages:</b> “Too Low, Terrain”</p>
None	<p><b>Alert Type:</b> Informational</p> <p><b>Condition:</b> Voice Call Out (VCO-500)</p> <p><b>Aural Messages:</b> “Five-Hundred”</p>

## TERRAIN SYSTEM STATUS

During power-up, the terrain system conducts a self-test of its aural and visual annunciations. This test can also be manually initiated. An aural alert is issued at test completion. Terrain system testing is disabled when ground speed exceeds 30 knots.

ANNUNCIATION	ALERT TYPE   CONDITION   AURAL MESSAGE
None	<b>Alert Type:</b> Informational <b>Condition:</b> Terrain Available <b>Aural Messages:</b> None
TER TEST	<b>Alert Type:</b> Informational <b>Condition:</b> Terrain System Test in Progress <b>Aural Messages:</b> None
None	<b>Alert Type:</b> Informational <b>Condition:</b> Terrain System Test Pass <b>Aural Messages:</b> "Terrain System Test OK"
TER N/A	<b>Alert Type:</b> Caution <b>Condition:</b> Terrain N/A <b>Aural Messages:</b> "Terrain Not Available"
TER INHB	<b>Alert Type:</b> Informational <b>Condition:</b> Terrain Alerting is Disabled <b>Aural Messages:</b> None
TER FAIL	<b>Alert Type:</b> Caution <b>Condition:</b> Terrain System Test Fail <b>Aural Messages:</b> "Terrain System Failure"

# Alert Inhibit, TAWS & Terrain Alerting



The **Terrain Inhibit** control is accessible via the Terrain page menu.

Always use discretion when inhibiting TAWS or Terrain Alerting alerts. Re-activate the alert function when appropriate.

TERRAIN INHIBIT FUNCTIONS	
<b>INHIBIT</b>	Manually inhibits TAWS or Terrain Alerting aural and visual alerts for low altitude approaches or rotorcraft operation.
<b>AUTOMATIC INHIBIT</b>	<p>Automatically inhibits TAWS and Terrain Alerting alerts when the aircraft meets the following approach criteria.</p> <p style="text-align: center;"><b>TAWS:</b></p> <ul style="list-style-type: none"> <li>• GPS/SBAS approach</li> <li>• Position inside FAF</li> </ul> <p style="text-align: center;"><b>TAWS &amp; TERRAIN ALERTING:</b></p> <ul style="list-style-type: none"> <li>• Altitude &lt;200 ft above runway elevation</li> <li>• Position &lt;0.5 nm of approach end or between each runway end</li> </ul>

## TAWS-A INHIBIT ANNUNCIATIONS

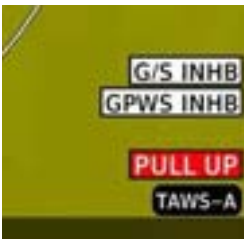

**Terrain Page Annunciations**

- TAWS-A alert inhibit annunciations appear at the bottom right of the display.
- “FLAP OVRD” does not annunciate if GPWS Inhibit is already active, as both functions inhibit FIT alerts.
- A plus sign indicates multiple alerts.

**TAWS INHB+**

# TAWS-B

## FEATURE REQUIREMENTS

- *Valid 3-D GPS position*
- *TAWS-B feature enablement*

## TAWS-B Features

- Optional TSO-C151d Class B terrain alerting system
- All Terrain alerting functions plus: premature descent, excessive descent rate, negative climb rate, and altitude voice callout (500 ft) alerts

## TAWS-B Setup Selections

<b>View</b>	Selects 360° or Arc view on terrain page.
<b>Layers</b>	Selects to display flight plan and/or legend on the terrain page.
<b>TAWS Inhibit</b>	Prevents TAWS alerts.
<b>Test</b>	Tests the TAWS system. Available only when the aircraft is on the ground.

## TAWS-B Alerts

TAWS-B ALERTS	
ANNUNCIATION	ALERT TYPE   POP-UP   CONDITION
PULL UP	<p><b>Alert Type:</b> <b>Warning</b></p> <p><b>Condition:</b> Excessive Descent Rate Warning (EDR-W)</p> <p><b>Aural Message:</b> “Pull Up”</p>
	<p><b>Alert Type:</b> <b>Warning</b></p> <p><b>Condition:</b> FLTA Terrain Warning (RTC-W, ITI-W)</p> <p><b>Aural Message:</b></p> <ul style="list-style-type: none"> <li>• “Terrain Ahead, Pull Up; Terrain Ahead, Pull Up”</li> </ul> <p><b>or</b></p> <ul style="list-style-type: none"> <li>• “Terrain, Terrain; Pull Up, Pull Up”</li> </ul>
	<p><b>Alert Type:</b> <b>Warning</b></p> <p><b>Condition:</b> FLTA Obstacle Warning (ROC-W, IOI-W)</p> <p><b>Aural Message:</b></p> <ul style="list-style-type: none"> <li>• “Obstacle Ahead, Pull Up; Obstacle Ahead, Pull Up”</li> </ul> <p><b>or</b></p> <ul style="list-style-type: none"> <li>• “Obstacle, Obstacle; Pull Up, Pull Up”</li> </ul>
TERRAIN	<p><b>Alert Type:</b> <b>Caution</b></p> <p><b>Condition:</b> FLTA Terrain Caution (RTC-C, ITI-C)</p> <p><b>Aural Message:</b></p> <ul style="list-style-type: none"> <li>• “Terrain Ahead; Terrain Ahead”</li> </ul> <p><b>or</b></p> <ul style="list-style-type: none"> <li>• “Caution, Terrain; Caution, Terrain”</li> </ul>

TAWS-B ALERTS	
ANNUNCIATION	ALERT TYPE   POP-UP   CONDITION
OBSTACLE	<p><b>Alert Type:</b> Caution</p> <p><b>Condition:</b> FLTA Obstacle Caution (ROC-C, IOI-C)</p> <p><b>Aural Message:</b></p> <ul style="list-style-type: none"> <li>“Obstacle Ahead; Obstacle Ahead”</li> </ul> <p><b>or</b></p> <ul style="list-style-type: none"> <li>“Caution, Obstacle; Caution, Obstacle”</li> </ul>
WIRE	<p><b>Alert Type:</b> Caution</p> <p><b>Condition:</b> FLTA Wire Caution (ILI-C, RLC-C)</p> <p><b>Aural Message:</b></p> <ul style="list-style-type: none"> <li>“Wire Ahead, Wire Ahead”</li> </ul> <p><b>or</b></p> <ul style="list-style-type: none"> <li>“Caution Wire, Caution, Wire”</li> </ul>
TERRAIN	<p><b>Alert Type:</b> Caution</p> <p><b>Condition:</b> Premature Descent Alert Caution (PDA)</p> <p><b>Aural Message:</b> “Too Low, Terrain”</p>
	<p><b>Alert Type:</b> Caution</p> <p><b>Condition:</b> Excessive Descent Rate Caution (EDR-C)</p> <p><b>Aural Message:</b> “Sink Rate”</p>
	<p><b>Alert Type:</b> Caution</p> <p><b>Condition:</b> Negative Climb Rate Caution (NCR-C)</p> <p><b>Aural Message:</b></p> <ul style="list-style-type: none"> <li>“Don’t Sink”</li> </ul> <p><b>or</b></p> <ul style="list-style-type: none"> <li>“Too Low, Terrain”</li> </ul>
None	<p><b>Alert Type:</b> Informational</p> <p><b>Condition:</b> Voice Call Out (VCO-500)</p> <p><b>Aural Message:</b> “Five-Hundred”</p>

### Altitude VCO

TAWS-B provides aural advisory alerts as the aircraft descends, beginning at 500 feet above the terrain, as determined by the radar altimeter (if greater than 5 NM from the nearest airport) or 500 feet above the nearest runway threshold elevation (if less than 5 NM from the nearest airport). Upon descent to this altitude, TAWS-B issues the aural alert message “Five-hundred.”

### TAWS-B Not Available Alert

TAWS-B requires a 3-D GPS position solution along with specific vertical accuracy minimums. Should the position solution become degraded or if the aircraft is out of the database coverage area, the annunciation “TAWS N/A” is generated in the annunciation window and on the TAWS-B page. The aural message “TAWS Not Available” is generated. When the GPS signal is re-established and the aircraft is within the database coverage area, the aural message “TAWS Available” is generated (when the aircraft is airborne).

### TAWS-B Failure Alert

TAWS-B continually monitors several system-critical items such as database validity, hardware status, and GPS status. If the terrain/obstacle database is not available, the aural message “TAWS System Failure” is generated along with a “TAWS FAIL” annunciation.

## TAWS-B SYSTEM STATUS

During power-up, TAWS-B conducts a self-test of its aural and visual annunciations. The system test can also be manually initiated. An aural alert is issued at test completion. TAWS System Testing is disabled when ground speed exceeds 30 knots.

ANNUNCIATION	ALERT TYPE	AURAL MESSAGE
None	TAWS Available	“TAWS Available”
<b>TAWS TEST</b>	TAWS System Test in Progress	None
None	TAWS System Test Pass	“TAWS System Test OK”
<b>TAWS N/A</b>	TAWS N/A	“TAWS Not Available”
<b>TAWS INHB</b>	TAWS Alerting is Disabled	None
<b>TAWS FAIL</b>	TAWS System Test Fail	“TAWS System Failure”

# TAWS-A

## FEATURE REQUIREMENTS

- Valid terrain/obstacle/navigation database
- Valid 3-D GPS position
- Valid flap and landing gear status inputs
- Valid radar altimeter
- Valid air data computer

Class A TAWS incorporates radar altimeter input with the GSL altitude to provide a more accurate position reference when at lower altitudes for certain alert types, and to retain a level of ground proximity warning capability in the unlikely event of a navigation, terrain or obstacle database failure.

## TAWS-A Features

- Optional TSO-C151d Class A terrain alerting system
- All Terrain-FLTA functions plus: premature descent, excessive descent and closure rate, negative climb rate, flight into terrain, excessive below glideslope/glidepath deviation
- Visual and aural annunciations when terrain and obstacles are within the given altitude threshold from the aircraft

## TAWS-A Setup Selections

Tap **Menu** to access setup options. Selections are grouped by function: View, Layers, and TAWS.

### INHIBIT

Manually inhibits FLTA or PDA visual alerts for low altitude approaches.

### AUTOMATIC INHIBIT

Automatically inhibits FLTA alerts when the aircraft meets the following approach criteria.

- Altitude <200 ft above runway elevation
- Position <0.5 nm off approach end or between each runway end



## TAWS-A Alerts

TAWS-A ALERTS	
ANNUNCIATION	ALERT TYPE   POP-UP   CONDITION
PULL UP	<p><b>Alert Type:</b> <b>Warning</b></p> <p><b>Condition:</b> Reduced Required Terrain Clearance (RTC)</p> <p><b>Pop-up Alert:</b></p> <ul style="list-style-type: none"> <li>• “Terrain - Pull Up”</li> </ul> <p><b>or</b></p> <ul style="list-style-type: none"> <li>• “Terrain Ahead - Pull Up”</li> </ul> <p><b>Aural Message:</b></p> <ul style="list-style-type: none"> <li>• “Terrain, Terrain; Pull Up, Pull Up”</li> </ul> <p><b>or</b></p> <ul style="list-style-type: none"> <li>• “Terrain Ahead, Pull Up; Terrain Ahead, Pull Up”</li> </ul>
	<p><b>Alert Type:</b> <b>Warning</b></p> <p><b>Condition:</b> Imminent Terrain Impact (ITI)</p> <p><b>Pop-up Alert:</b></p> <ul style="list-style-type: none"> <li>• “Terrain - Pull Up”</li> </ul> <p><b>or</b></p> <ul style="list-style-type: none"> <li>• “Terrain Ahead - Pull Up”</li> </ul> <p><b>Aural Message:</b></p> <ul style="list-style-type: none"> <li>• “Terrain, Terrain; Pull Up, Pull Up”</li> </ul> <p><b>or</b></p> <ul style="list-style-type: none"> <li>• “Terrain Ahead, Pull Up; Terrain Ahead, Pull Up”</li> </ul>
	<p><b>Alert Type:</b> <b>Warning</b></p> <p><b>Condition:</b> Reduced Required Obstacle Clearance (ROC)</p> <p><b>Pop-up Alert:</b></p> <ul style="list-style-type: none"> <li>• “Obstacle Pull Up”</li> </ul> <p><b>or</b></p> <ul style="list-style-type: none"> <li>• “Obstacle Ahead - Pull Up”</li> </ul> <p><b>Aural Message:</b></p> <ul style="list-style-type: none"> <li>• “Obstacle, Obstacle; Pull Up, Pull Up”</li> </ul> <p><b>or</b></p> <ul style="list-style-type: none"> <li>• “Obstacle Ahead, Pull Up; Obstacle Ahead, Pull Up”</li> </ul>

TAWA-A ALERTS	
ANNUNCIATION	ALERT TYPE   POP-UP   CONDITION
PULL UP	<p><b>Alert Type:</b> Warning</p> <p><b>Condition:</b> Imminent Obstacle Impact (IOI)</p> <p><b>Pop-up Alert:</b></p> <ul style="list-style-type: none"> <li>• “Obstacle Pull Up”</li> </ul> <p><b>or</b></p> <ul style="list-style-type: none"> <li>• “Obstacle Ahead - Pull Up”</li> </ul> <p><b>Aural Message:</b></p> <ul style="list-style-type: none"> <li>• “Obstacle, Obstacle; Pull Up, Pull Up”</li> </ul> <p><b>or</b></p> <ul style="list-style-type: none"> <li>• “Obstacle Ahead, Pull Up; Obstacle Ahead, Pull Up”</li> </ul>
	<p><b>Alert Type:</b> Warning</p> <p><b>Condition:</b> Excessive Descent Rate (EDR)</p> <p><b>Pop-up Alert:</b> “Pull Up”</p> <p><b>Aural Message:</b> “&lt;whoop&gt; &lt;whoop&gt; Pull Up”</p>
	<p><b>Alert Type:</b> Warning</p> <p><b>Condition:</b> Excessive Closure Rate (ECR)</p> <p><b>Pop-up Alert:</b> “Pull Up”</p> <p><b>Aural Message:</b> “&lt;whoop&gt; &lt;whoop&gt; Pull Up”</p>
	<p><b>Alert Type:</b> Warning</p> <p><b>Condition:</b> Imminent Line Impact (ILI)</p> <p><b>Pop-up Alert:</b> “Wire Ahead - Pull Up”</p> <p><b>Aural Message:</b></p> <ul style="list-style-type: none"> <li>• “Wire Ahead, Pull Up; Wire Ahead, Pull Up”</li> </ul> <p><b>or</b></p> <ul style="list-style-type: none"> <li>• “Wire, Wire; Pull Up, Pull Up”</li> </ul>
	<p><b>Alert Type:</b> Warning</p> <p><b>Condition:</b> Reduced Line Clearance (RLC)</p> <p><b>Pop-up Alert:</b> “Wire Ahead - Pull Up”</p> <p><b>Aural Message:</b></p> <ul style="list-style-type: none"> <li>• “Wire Ahead, Pull Up; Wire Ahead, Pull Up”</li> </ul> <p><b>or</b></p> <ul style="list-style-type: none"> <li>• “Wire, Wire; Pull Up, Pull Up”</li> </ul>
	<p><b>Alert Type:</b> Warning</p> <p><b>Condition:</b> Excessive Closure Rate (ECR)</p> <p><b>Pop-up Alert:</b> “Pull Up”</p> <p><b>Aural Message:</b> “&lt;whoop&gt; &lt;whoop&gt; Pull Up”</p>

TAWS-A ALERTS	
ANNUNCIATION	ALERT TYPE   POP-UP   CONDITION
TERRAIN	<p><b>Alert Type:</b> Caution</p> <p><b>Condition:</b> Reduced Required Terrain Clearance (RTC)</p> <p><b>Pop-up Alert:</b></p> <ul style="list-style-type: none"> <li>• “Caution - Terrain”</li> </ul> <p><b>or</b></p> <ul style="list-style-type: none"> <li>• “Terrain Ahead”</li> </ul> <p><b>Aural Message:</b></p> <ul style="list-style-type: none"> <li>• “Caution, Terrain; Caution, Terrain”</li> </ul> <p><b>or</b></p> <ul style="list-style-type: none"> <li>• “Terrain Ahead; Terrain Ahead”</li> </ul>
	<p><b>Alert Type:</b> Caution</p> <p><b>Condition:</b> Imminent Terrain Impact (ITI)</p> <p><b>Pop-up Alert:</b></p> <ul style="list-style-type: none"> <li>• “Caution - Terrain”</li> </ul> <p><b>or</b></p> <ul style="list-style-type: none"> <li>• “Terrain Ahead”</li> </ul> <p><b>Aural Message:</b></p> <ul style="list-style-type: none"> <li>• “Caution, Terrain; Caution, Terrain”</li> </ul> <p><b>or</b></p> <ul style="list-style-type: none"> <li>• “Terrain Ahead; Terrain Ahead”</li> </ul>

TAWS-A ALERTS	
ANNUNCIATION	ALERT TYPE   POP-UP   CONDITION
OBSTACLE	<p><b>Alert Type:</b> Caution</p> <p><b>Condition:</b> Reduced Required Obstacle Clearance (ROC)</p> <p><b>Pop-up Alert:</b></p> <ul style="list-style-type: none"> <li>• "Caution - Obstacle"</li> </ul> <p><b>or</b></p> <ul style="list-style-type: none"> <li>• "Obstacle Ahead"</li> </ul> <p><b>Aural Message:</b></p> <ul style="list-style-type: none"> <li>• "Caution, Obstacle; Caution, Obstacle"</li> </ul> <p><b>or</b></p> <ul style="list-style-type: none"> <li>• "Obstacle Ahead; Obstacle Ahead"</li> </ul>
	<p><b>Alert Type:</b> Caution</p> <p><b>Condition:</b> Imminent Obstacle Impact (IOI)</p> <p><b>Pop-up Alert:</b></p> <ul style="list-style-type: none"> <li>• "Caution - Obstacle"</li> </ul> <p><b>or</b></p> <ul style="list-style-type: none"> <li>• "Obstacle Ahead"</li> </ul> <p><b>Aural Message:</b></p> <ul style="list-style-type: none"> <li>• "Obstacle Ahead; Obstacle Ahead"</li> </ul> <p><b>or</b></p> <ul style="list-style-type: none"> <li>• "Caution, Obstacle; Caution, Obstacle"</li> </ul>
WIRE	<p><b>Alert Type:</b> Caution</p> <p><b>Condition:</b> Imminent Line Impact (ILI)</p> <p><b>Pop-up Alert:</b> "Wire Ahead"</p> <p><b>Aural Message:</b></p> <ul style="list-style-type: none"> <li>• "Wire Ahead; Wire Ahead"</li> </ul> <p><b>or</b></p> <ul style="list-style-type: none"> <li>• "Caution, Wire; Caution, Wire"</li> </ul>

TAWA-A ALERTS	
ANNUNCIATION	ALERT TYPE   POP-UP   CONDITION
WIRE	<p><b>Alert Type:</b> Caution</p> <p><b>Condition:</b> Reduced Line Clearance (RLC)</p> <p><b>Pop-up Alert:</b> "Wire Ahead"</p> <p><b>Aural Message:</b></p> <ul style="list-style-type: none"> <li>"Wire Ahead; Wire Ahead"</li> </ul> <p><b>or</b></p> <ul style="list-style-type: none"> <li>"Caution, Wire; Caution, Wire"</li> </ul>
	<p><b>Alert Type:</b> Caution</p> <p><b>Condition:</b> Premature Descent Alert (PDA)</p> <p><b>Pop-up Alert:</b> "Don't Sink"</p> <p><b>Aural Message:</b> "Too Low, Terrain"</p>
TERRAIN	<p><b>Alert Type:</b> Caution</p> <p><b>Condition:</b> Excessive Descent Rate (EDR)</p> <p><b>Pop-up Alert:</b> "Sink Rate"</p> <p><b>Aural Message:</b> "Sink Rate"</p>
	<p><b>Alert Type:</b> Caution</p> <p><b>Condition:</b> Excessive Closure Rate (ECR)</p> <p><b>Pop-up Alert:</b> "Terrain"</p> <p><b>Aural Message:</b> "Terrain, Terrain"</p>
	<p><b>Alert Type:</b> Caution</p> <p><b>Condition:</b> Negative Climb Rate (NCR)</p> <p><b>Pop-up Alert:</b></p> <ul style="list-style-type: none"> <li>"Don't Sink"</li> </ul> <p><b>or</b></p> <ul style="list-style-type: none"> <li>"Too Low - Terrain"</li> </ul> <p><b>Aural Message:</b></p> <ul style="list-style-type: none"> <li>"Don't Sink"</li> </ul> <p><b>or</b></p> <ul style="list-style-type: none"> <li>"Too Low, Terrain"</li> </ul>
	<p><b>Alert Type:</b> Caution</p> <p><b>Condition:</b> Negative Climb Rate (NCR)</p> <p><b>Pop-up Alert:</b></p> <ul style="list-style-type: none"> <li>"Don't Sink"</li> </ul> <p><b>or</b></p> <ul style="list-style-type: none"> <li>"Too Low - Terrain"</li> </ul> <p><b>Aural Message:</b></p> <ul style="list-style-type: none"> <li>"Don't Sink"</li> </ul> <p><b>or</b></p> <ul style="list-style-type: none"> <li>"Too Low, Terrain"</li> </ul>

TAWS-A ALERTS	
ANNUNCIATION	ALERT TYPE   POP-UP   CONDITION
TERRAIN	<b>Alert Type:</b> Caution <b>Condition:</b> Flight Into Terrain High Speed (FIT) <b>Pop-up Alert:</b> "Too Low, Terrain" <b>Aural Message:</b> "Too Low, Terrain"
	<b>Alert Type:</b> Caution <b>Condition:</b> Flight Into Terrain Gear (FIT) <b>Pop-up Alert:</b> "Too Low, Gear" <b>Aural Message:</b> "Too Low, Gear"
	<b>Alert Type:</b> Caution <b>Condition:</b> Flight Into Terrain Flaps (FIT) <b>Pop-up Alert:</b> "Too Low, Flaps" <b>Aural Message:</b> "Too Low, Flaps"
	<b>Alert Type:</b> Caution <b>Condition:</b> Flight Into Terrain Takeoff (FIT) <b>Pop-up Alert:</b> "Too Low, Terrain" <b>Aural Message:</b> "Too Low, Terrain"
GLIDESLOPE	<b>Alert Type:</b> Caution <b>Condition:</b> Glideslope Deviation (GSD) <b>Pop-up Alert:</b> "Glideslope" <b>Aural Message:</b> "Glideslope"
None	<b>Alert Type:</b> Informational <b>Condition:</b> Altitude Voice Call Out (VCO) <b>Pop-up Alert:</b> None <b>Aural Message:</b> "Five-Hundred"
	<b>Alert Type:</b> Informational <b>Condition:</b> TAWS Available <b>Pop-up Alert:</b> N/A <b>Aural Message:</b> "TAWS Available"

TAWA-A ALERTS	
ANNUNCIATION	ALERT TYPE   POP-UP   CONDITION
TAWA TEST	<p><b>Alert Type:</b> Informational</p> <p><b>Condition:</b> TAWA system test in progress.</p> <p><b>Pop-up Alert:</b> N/A</p> <p><b>Aural Message:</b> None</p>
None	<p><b>Alert Type:</b> Informational</p> <p><b>Condition:</b> TAWA System Test Pass</p> <p><b>Pop-up Alert:</b> N/A</p> <p><b>Aural Message:</b> "TAWA System Test OK"</p>
TAWA N/A	<p><b>Alert Type:</b> Caution</p> <p><b>Condition:</b> TAWA N/A</p> <p><b>Pop-up Alert:</b> N/A</p> <p><b>Aural Message:</b> "TAWA Not Available"</p>
TAWA INHB	<p><b>Alert Type:</b> Informational</p> <p><b>Condition:</b> TAWA Alerting is disabled.</p> <p><b>Pop-up Alert:</b> N/A</p> <p><b>Aural Message:</b> None</p>
TAWA FAIL	<p><b>Alert Type:</b> Caution</p> <p><b>Condition:</b> TAWA system test has failed.</p> <p><b>Pop-up Alert:</b> N/A</p> <p><b>Aural Message:</b> "TAWA System Failure"</p>
	<p><b>Alert Type:</b> Caution<sup>†</sup></p> <p><b>Condition:</b></p> <ul style="list-style-type: none"> <li>• Incorrect TAWA configuration</li> <li>• Invalid/missing terrain, airport, or obstacle database</li> <li>• TAWA audio fault</li> </ul> <p><b>Pop-up Alert:</b> N/A</p> <p><b>Aural Message:</b> "TAWA System Failure"</p>

TAWS-A ALERTS	
ANNUNCIATION	ALERT TYPE   POP-UP   CONDITION
TAWS N/A	<p><b>Alert Type:</b> Caution</p> <p><b>Condition:</b> No GPS position</p> <p><b>Pop-up Alert:</b> N/A</p> <p><b>Aural Message:</b> "TAWS Not Available"</p>
	<p><b>Alert Type:</b> Caution</p> <p><b>Condition:</b> GPS position unavailable/degraded. Outside of terrain database coverage.</p> <p><b>Pop-up Alert:</b> N/A</p> <p><b>Aural Message:</b> "TAWS Not Available"</p>
None	<p><b>Alert Type:</b> Informational</p> <p><b>Condition:</b> Sufficient GPS signal reception restored.</p> <p><b>Pop-up Alert:</b> N/A</p> <p><b>Aural Message:</b> "TAWS Available" (aural message only in flight)</p>
GPWS FAIL	<p><b>Alert Type:</b> Caution</p> <p><b>Condition:</b></p> <ul style="list-style-type: none"> <li>• Incorrect TAWS configuration</li> <li>• Radar altimeter unavailable</li> <li>• GPS position unavailable/degraded</li> <li>• TAWS audio fault</li> </ul> <p><b>Pop-up Alert:</b> N/A</p> <p><b>Aural Message:</b> "GPWS System Failure"</p>
GPWS INHB	<p><b>Alert Type:</b> Informational</p> <p><b>Condition:</b> GPWS Inhibit</p> <p><b>Pop-up Alert:</b> None</p> <p><b>Aural Message:</b> "GPWS System Failure"</p>

TAWA-A ALERTS	
ANNUNCIATION	ALERT TYPE   POP-UP   CONDITION
GPWS N/A	<p><b>Alert Type:</b> Caution</p> <p><b>Condition:</b></p> <ul style="list-style-type: none"> <li>• GPWS Not Available</li> <li>• Incorrect TAWS configuration</li> <li>• Radar altimeter unavailable</li> <li>• GPS position unavailable/degraded</li> <li>• TAWS audio fault</li> </ul> <p><b>Pop-up Alert:</b> N/A</p> <p><b>Aural Message:</b> “GPWS System Failure”</p>
G/S INHB	<p><b>Alert Type:</b> Informational</p> <p><b>Condition:</b> Glideslope Inhibit</p> <p><b>Pop-up Alert:</b> N/A</p> <p><b>Aural Message:</b> None</p>
FLAP OVRD	<p><b>Alert Type:</b> Informational</p> <p><b>Condition:</b> FLAP Override</p> <p><b>Pop-up Alert:</b> N/A</p> <p><b>Aural Message:</b> None</p>

† VCO alerts are not issued if both TAWS and GPWS systems have failed or are not available.

GSD alert will be available if a valid ILS is being used for navigation, even in no valid GPS signal is being received.

## ENABLE FLAP OVERRIDE

When the Flaps Override option is enabled, the annunciation “FLAP OVRD” is annunciated on the TAWS-A Page. If GPWS alerts are also inhibited (which include FIT), the “FLAP OVRD” annunciation is not shown.

1. Tap **Menu**.
2. Tap **Flap Override** to toggle the override state.

GSD alerting is only active after departure and the following conditions are met:

- An ILS, LPV, LNAV/VNAV, or LNAV+V approach is active and vertical navigation indications are being displayed.
- Aircraft is below 1000 feet AGL.
- Gear is configured for landing.

When a GSD caution alert occurs, the aural and visual annunciation “GLIDESLOPE” is issued. If a GSD caution alert occurs on an LPV, LNAV/VNAV, or LNAV+V approach, the aural and visual annunciation “GLIDESLOPE” is issued.

## INHIBITING GLIDESLOPE DEVIATION (GSD) ALERTS

When G/S alerts are inhibited, they are only inhibited for a single approach. To inhibit G/S alerts on the next approach, the G/S Inhibit function must be activated again between the first and second approaches.

1. Tap **Menu**.
2. Tap **G/S Inhibit** to inhibit or enable glideslope or glidepath alerts.

The Glideslope (G/S) Inhibit function:

- Should be activated when flying a localizer backcourse approach to prevent nuisance GSD alerts
- GSD alerts are inhibited independent from all other FLTA, PDA, and GPWS alerts
- Will only be active for a single approach and will not remain active for subsequent approaches

## INHIBITING GPWS ALERTS (EDR, ECR, FIT, AND NCR)

The "Inhibit GPWS" function only affects GPWS alerts (EDR, ECR, NCR, and FIT). Alerting for FLTA, PDA, and GSD is controlled independently from the GPWS alerts listed below.

EDR, ECR, FIT, and NCR aural and visual alerts can be manually inhibited as a group. Discretion should be used when inhibiting alerts and the GPWS system should be enabled when appropriate. When these alerts are inhibited, the alert annunciation "GPWS INH" is shown on the TAWS-A Page annunciation window.

1. Tap **Menu**.
2. Tap **GPWS Inhibit** to inhibit or enable GPWS alerts (choice dependent on current state).



### ALTITUDE VOICE CALL OUT (VCO)

TAWS-A provides aural advisory alerts as the aircraft descends, beginning at 500 feet above the terrain, as determined by the radar altimeter (if greater than 5 NM from the nearest airport) or 500 feet above the nearest runway threshold elevation (if less than 5 NM from the nearest airport). Upon descent to this altitude, TAWS-A issues the aural alert message “Five-hundred.”

### TAWS-A SYSTEM STATUS

During power-up, TAWS-A conducts a self-test of its aural and visual annunciations. The system test can also be manually initiated. An aural alert is issued at test completion. TAWS-A System Testing is disabled when ground speed exceeds 30 knots.

### TAWS-A ABNORMAL OPERATIONS

TAWS-A continually monitors several system-critical items such as database validity, flap and landing gear position, radar altimeter input, and GPS status.

If the GTN does not contain Terrain and Obstacle databases (or the databases are invalid), the aural message “TAWS System Failure” is generated along with the “TAWS FAIL” alert annunciation.

TAWS-A requires a 3-D GPS navigation solution along with specific vertical accuracy minimums. Should the navigation solution become degraded or if the aircraft is out of the database coverage area, the annunciation “TAWS N/A” is generated in the annunciation window and on the TAWS-A page, the aural message “TAWS Not Available” is generated if airborne, some TAWS-A terrain alerts will not be issued, and GPWS alerting (which are not dependent on GPS position) will continue to operate. When the GPS signal is re-established and the aircraft is within the database coverage area, the aural message “TAWS Available” is generated.

TAWS-A also requires radar altimeter input. Should the radar altimeter input fail or become degraded, the annunciation “GPWS FAIL” is generated in the annunciation window and on the TAWS-A Page. The aural message “GPWS System Failure” is also generated. The “GPWS FAIL” annunciation will also occur if both GPS altitude and barometric altitude are unavailable. If only the GPWS system has failed, GPWS-based alerts will not be available, while other TAWS-A alerting remains unaffected.

Multiple TAWS or GPWS annunciations cannot be displayed at the same time. When multiple annunciations exist, a plus-sign will be present next to the annunciation. The display of each annunciation will alternate with each being displayed for approximately five seconds.

# HTAWS/(H)Terrain Alerting



## NOTE

HTAWS-enabled units can be identified by going to the Terrain page and checking the lower right-corner for “HTAWS.”

### FEATURE REQUIREMENTS

- Valid 3D GPS position
- Valid terrain/obstacle database

Garmin’s Helicopter Terrain Awareness Warning System (HTAWS) is an optional feature to increase situational awareness and aid in reducing controlled flight into terrain. Garmin HTAWS is TSO-C194 authorized. (H)Terrain Alerting is **not** TSO-C194 authorized.

HTAWS provides visual and aural annunciations when terrain and obstacles are a hazard to the aircraft.

HTAWS Terrain Display

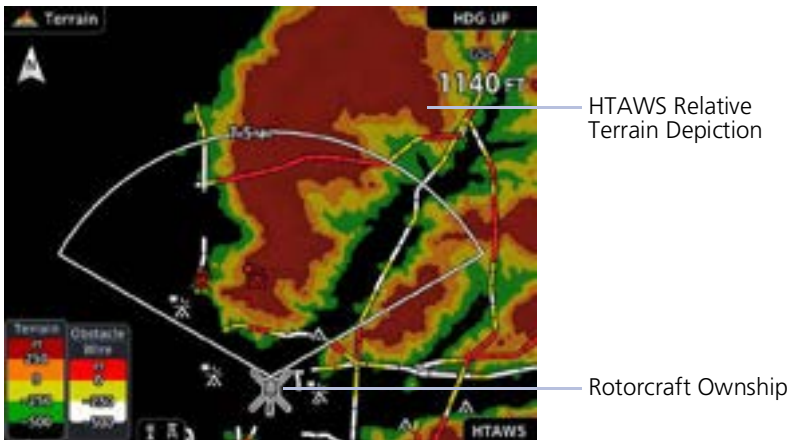

## POWER UP

During power-up of the unit, the terrain/obstacle database versions are displayed along with a disclaimer to the pilot. At the same time, HTAWS self-test begins. HTAWS gives the following aural messages upon test completion:

- “**HTAWS System Test, OK,**” if the system passes the test
- “**HTAWS System Failure,**” if the system fails the test

A test failure is also annunciated visually for HTAWS, as shown in the HTAWS Alert Summary table.

### HTAWS Setup Selections

The HTAWS page menu provides options to acknowledge caution alerts, reduce protection, or inhibit alerting

<b>View</b>	Selects 360° or Arc view on terrain page.
<b>Layers</b>	Selects to display flight plan and/or legend on the terrain page.
<b>RP Mode</b>	<ul style="list-style-type: none"><li>• Reduces the alerting thresholds, and suppresses visual and aural annunciation of caution alerts.</li><li>• An external RP Mode switch and an external alert acknowledge switch can be used.</li><li>• “RP Mode” displays in the terrain annunciator field whenever protection is reduced.</li></ul>
<b>HTAWS Inhibit</b>	<p>When the ground speed is less than 30 knots HTAWS automatically displays “HTAWS INHB” and cannot be removed by menu option selection. Other features:</p> <ul style="list-style-type: none"><li>• Inhibit mode deactivates aural and visual alerts</li><li>• Use discretion when inhibiting the HTAWS system and remember to enable the system when appropriate</li><li>• VCOs are not inhibited in Inhibit Mode</li><li>• All FLTA aural and visual alerting suppressed</li><li>• HTAWS should only be inhibited when in visual contact with terrain and obstacles</li><li>• HTAWS configured units will always start up with HTAWS alerts uninhibited.</li></ul>
<b>Test HTAWS</b>	<ul style="list-style-type: none"><li>• Tests the HTAWS system.</li><li>• Available only when the rotorcraft is on the ground.</li><li>• An aural message plays giving the test results: “HTAWS System Test, OK” if the system passes the test “HTAWS System Failure” if the system fails the test</li></ul>

## HTAWS Alerts

- HTAWS alerts employ either a CAUTION or WARNING alert severity level
- Visual annunciations display when alert is issued
- Aural alerts are simultaneously issued
- Annunciations appear in dedicated field in the lower left corner of the display
- HTAWS Caution Alerts display as constant black text on a yellow background
- HTAWS Warning Alerts display as constant white text on a red background

## FORWARD LOOKING TERRAIN AVOIDANCE

Unit issues terrain alerts when the aircraft altitude is below the terrain elevation and when aircraft is projected to come within minimum clearance values of the terrain.

Any threat locations are depicted on the display. There are two levels of severity for FLTA alerts. They are cautionary (amber) and warning (red).

### FLTA Caution:

- Estimated potential impact in approximately 30 seconds after a caution pop-up alert and annunciation.
- Accompanied by the aural message “Caution Terrain; Caution Terrain.”
- The time to an alert can vary with conditions, therefore there is no guarantee of a 30 second caution alert being issued.

### FLTA Warning:

- Warning pop-up alerts issued 15 seconds prior to estimated potential impact in normal mode and approximately 10 seconds in RP Mode.
- Accompanied by the aural message “Warning - Terrain, Terrain” or “Warning - Obstacle, Obstacle.”
- The time to an alert can vary with conditions, therefore there is no guarantee of a 15/10 second warning alert being issued.

## HTAWS VOICE CALL OUT (VCO) AURAL ALERT

- VCO aural alert messages provide an advisory alert to the pilot the aircraft is between 500 feet and 100 feet above terrain in 100 foot increments.
- When the aircraft descends within the selected distance from terrain, the aural message for the selected height above terrain is generated.
- There are no display annunciations or pop-up alerts that accompany the aural message.
- HTAWS allows an additional 50 foot VCO alert with radar altimeter input.

### HTAWS VCO SELECTION

If a radar altimeter is interfaced to GTN, alerts are available down to 50 feet and the height above terrain when the radar altimeter is used to generate the callouts.

#### To select VCO choices:

1. Tap **System > Audio > Voice Callouts**.
2. Tap **MAX Voice Callout** to select the Voice Call Outs.
3. The values above the selected value will be disabled (Off).

### HTAWS NOT AVAILABLE ALERT

- Requires a 3-D GPS navigation solution along with specific vertical accuracy minimums.
- “HTAWS N/A” displays if solution becomes degraded or aircraft is out of database coverage area.

### HTAWS FAILURE ALERT

If the terrain/obstacle database is not available, the aural message “HTAWS System Failure” is issued along with the “HTAWS FAIL” annunciation.

### HTAWS ALERT SUMMARY

HTAWS Caution Alerts appear as constant black text on a yellow background.

HTAWS Warning Alerts appear as constant white text on a red background.

### PILOT ACTIONS

If an HTAWS warning and associated aural are received, the pilot should immediately maneuver the rotorcraft in response to the alert unless the terrain or obstacle is clearly identified visually and determined by the pilot not to be a factor to the safety of the operation.

A HTAWS caution alert indicates terrain or obstacle nearby. If possible visually locate the terrain or obstacle for avoidance. A HTAWS warning alert may follow a HTAWS caution unless the aircraft’s path towards the terrain or obstacle is changed.

Display of terrain and obstacles on the display is supplemental data only. Maneuvering solely by reference to the terrain and obstacle data is not recommended or authorized.

HTAWS ALERTS	
ANNUNCIATION	ALERT TYPE   POP-UP   CONDITION
TERRAIN	<b>Alert Type:</b> <b>Warning</b> <b>Condition:</b> FLTA Warning for Terrain <b>Pop-up Alert:</b> "Warning - Terrain" <b>Aural Message:</b> "Warning - Terrain, Terrain"
	<b>Alert Type:</b> <b>Caution</b> <b>Condition:</b> FLTA Caution for Terrain <b>Pop-up Alert:</b> "Caution - Terrain" <b>Aural Message:</b> "Caution -Terrain, Terrain"
OBSTACLE	<b>Alert Type:</b> <b>Warning</b> <b>Condition:</b> FLTA Warning for Obstacle <b>Pop-up Alert:</b> "Warning - Obstacle" <b>Aural Message:</b> "Warning - Obstacle, Obstacle"
	<b>Alert Type:</b> <b>Caution</b> <b>Condition:</b> FLTA Caution for Obstacle <b>Pop-up Alert:</b> "Caution - Obstacle" <b>Aural Message:</b> "Caution - Obstacle, Obstacle"
WIRE	<b>Alert Type:</b> <b>Warning</b> <b>Condition:</b> FLTA Warning for Power Lines <b>Pop-up Alert:</b> "Warning - Wire" <b>Aural Message:</b> "Wire Ahead Pull Up, Wire Ahead Pull Up"
	<b>Alert Type:</b> <b>Caution</b> <b>Condition:</b> FLTA Caution for Wire <b>Pop-up Alert:</b> "Caution - Wire" <b>Aural Message:</b> "Wire Ahead"
HTAWS FAIL	<b>Alert Type:</b> <b>Caution</b> <b>Condition:</b> HTAWS has failed. <b>Pop-up Alert:</b> None <b>Aural Message:</b> "HTAWS System Failure"

HTAWS ALERTS	
ANNUNCIATION	ALERT TYPE   POP-UP   CONDITION
HTAWS N/A	<p><b>Alert Type:</b> Caution</p> <p><b>Condition:</b> HTAWS is not available.</p> <p><b>Pop-up Alert:</b> None</p> <p><b>Aural Message:</b> "HTAWS Not Available"</p>
RP MODE	<p><b>Alert Type:</b> Informational</p> <p><b>Condition:</b> Alerting thresholds are reduced. Visual and aural annunciation of caution alerts are suppressed.</p> <p><b>Pop-up Alert:</b> None</p> <p><b>Aural Message:</b> None</p>
HTAWS INHB	<p><b>Alert Type:</b> Informational</p> <p><b>Condition:</b> HTAWS has been inhibited by the crew, or the aircraft ground speed is below 30 knots (automatic inhibiting).</p> <p><b>Pop-up Alert:</b> None</p> <p><b>Aural Message:</b> None</p>
None	<p><b>Alert Type:</b> N/A</p> <p><b>Condition:</b> HTAWS provides optional 500 ft through 100 ft (in 100 ft increments) altitude call out alerts. An additional value of 50 ft is available if a radar altimeter is installed.</p> <p><b>Pop-up Alert:</b> None</p> <p><b>Aural Messages:</b></p> <ul style="list-style-type: none"> <li>• "Five Hundred"</li> <li>• "Four Hundred"</li> <li>• "Three Hundred"</li> <li>• "Two Hundred"</li> <li>• "One Hundred"</li> <li>• "Fifty"</li> </ul>

# 6 Services

SIRIUSXM AUDIO ENTERTAINMENT .....	6-3
CONNEXT SERVICES.....	6-9

### SERVICES APPS & FUNCTIONS

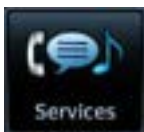

Optional satellite services are available when your unit is connected to a GDL 69/69A datalink receiver (Music) or GSR 56 Iridium transceiver (Phone, SMS Text, and Position Reports).



#### Phone

- Place telephone calls
- Set up call notifications



#### SMS Text

- Compose & send messages
- Receive messages
- Set up text notifications



#### Music

- Tune SXM radio
- Adjust radio volume



#### Position Reports

- Set up automatic reporting
- Transmit reports manually



#### Contacts

- Manage contacts
- Call or message contacts

# SiriusXM Audio Entertainment



The Music app provides controls for tuning and presetting satellite radio music channels. This subscription-based service is available through SiriusXM Satellite Radio.

## FEATURE REQUIREMENTS

- GDL 69A SiriusXM receiver
- Active SiriusXM Satellite Radio subscription



**Music Features**

<b>1</b>	Channel Selection Key	<b>5</b>	Browse Categories Key
<b>2</b>	Channel Seek Controls	<b>6</b>	Volume Key
<b>3</b>	Preset Group Key	<b>7</b>	Current Selection Info
<b>4</b>	Preset Channel Keys	<b>8</b>	SXM Signal Level

# SiriusXM Audio Activation

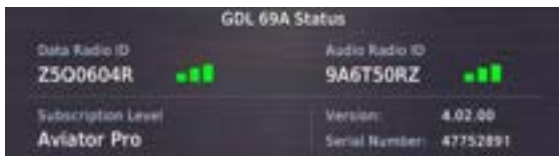

The GDL 69A Status page provides information necessary for activating SiriusXM Satellite Radio services.

## OPEN GDL 69A STATUS PAGE

You can access this page one of two ways.

### From the External LRUs list:

Home > **System** > **External LRUs**, locate GDL 69A and tap **More Info**

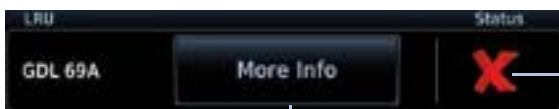

Activation Incomplete Indication

More Info Key

### From the Music page:

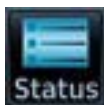

Home > **Services** > **Music** > **Status**

## COMPLETE SUBSCRIPTION ACTIVATION

1. Navigate to the GDL 69A Status page.
2. Verify activation. For entertainment subscriptions only, the status page displays your Audio Radio ID and subscription information.
3. Tap **Menu** > **Lock Activation** > **OK**.



## Adjust Radio Volume



Tap the **Volume** key to adjust or mute music volume.



**Mute** toggles radio volume on or off.

Mute On

## Direct Channel Tuning

### SiriusXM Radio Options

- Channels 0 to 999
- Categories 0 to 63

Music provides both numeric entry and channel seek functionality.



Tapping **CH Number** allows you to enter a specific radio channel by number. The channel, song, artist, and music category display for the current selection.



Seek controls allow you to step to the next or previous channel.

# Browse Music Channels

Tapping **Browse** allows you to scroll through a list of all available channels.



To filter the list according to a specific genre, tap **Category** and then choose one of the available music types.

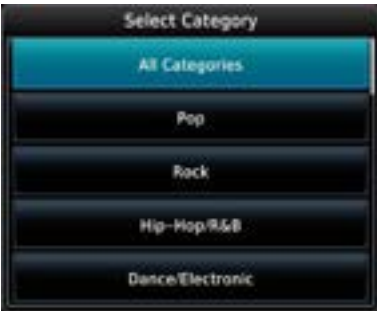

To choose all available types, select **All Categories**.

# Assign Channel Presets

## Quick Tuning Options

- Choice of three preset groups: XM 1, XM 2, XM 3
- Assign up to five preset channels per group

For quick tuning, use presets to store multiple channels in the unit's memory.

## ASSIGN A CHANNEL PRESET

1. Select a channel.
2. Tap **Presets** until the desired preset group displays.
3. Tap and hold any preset key for three seconds.



Unassigned Preset Keys

## SELECT A PRESET

1. Select a preset group (XM 1, XM 2, or XM 3).
2. Tap any assigned preset key.



Assigned Preset Keys

# XM Data Link Failure

If the Audio Radio ID and/or Data Radio ID do not display during GDL 69A operation, contact a Garmin dealer.



No Service Indication and Missing Audio ID

Failure Annunciation

## Troubleshooting the GDL 69/69A Datalink Receiver

GTN serves as the control head for your remotely mounted GDL 69/69A. In the event of a receiver failure:

- View datalink receiver status on the GDL 69 Status page
- Verify the SiriusXM Satellite Radio subscription is active
- Check circuit breakers to ensure power is applied to the receiver

It may take several minutes for all subscription data to become available after unit power up.

For more information, consult *GDL 69/69A SiriusXM Satellite Radio Activation Instructions*. For subscription activation instructions, visit <https://www.siriusxm.com/sxmaviation>.

# Connex Services



Optional 2-way text and voice communication and GPS-referenced position reporting apps are available through the Iridium satellite system.



## FEATURE REQUIREMENTS

- GSR 56 satellite datalink
- Iridium satellite network subscription
- Valid phone number or email address for 2-way text messaging via SMS

## FEATURE LIMITATIONS

- Applicable to the Iridium satellite telephone system only

## Phone



Make and receive telephone calls using the Iridium satellite communications network.

## WHERE TO FIND IT

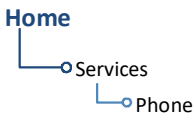

Phone is accessible from the Services menu.

Incoming calls generate a pop-up, allowing you to accept or ignore the call without leaving the current screen.

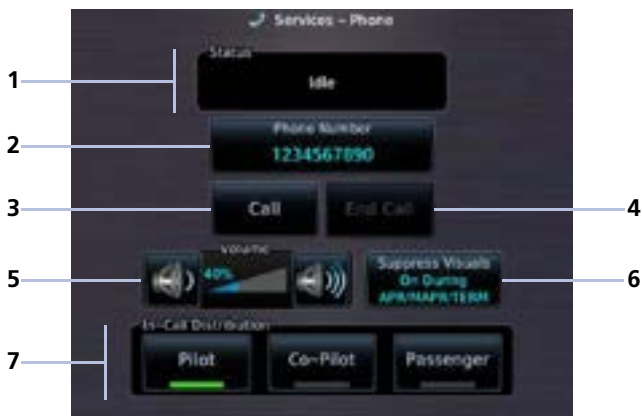

Phone Page



Phone Pop-up

1	Phone Status Window	5	Volume Controls
2	Phone Number Entry Key	6	Suppress Visuals Function
3	Call Key	7	In-call Distribution Controls <sup>†</sup>
4	End Call Key (inactive)		

<sup>†</sup> Available only when interfaced with a GMA 35 Audio Panel.

## Phone Volume

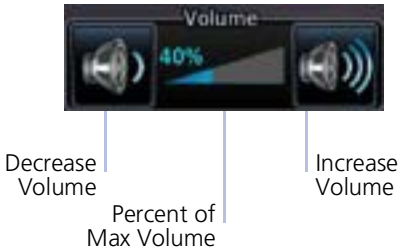

Tap the **Volume** keys to set telephone volume to the preferred level.

Volume displays as a percentage of the maximum volume, with 0% being muted and 100% being maximum volume.

These controls are grayed out when the function is not available.

### Volume controls are available only when Phone is:

- Idle
- Connected
- Changing Volume

## Phone Status Annunciations



Refer to the Status window for current call time and operating status.

ANNUNCIATION	MEANING
Idle	Phone is not communicating via GSR 56.
Initializing	GSR 56 and its driver are initializing.
Call Time ##:##	Duration of the current telephone call.
Connected	GSR 56 is connected to the dialed number.
Connecting Call	GSR 56 is in the process of connecting to the dialed number.
Changing Volume	The volume level on GSR 56 is fluctuating.
Busy	Phone is in use by another service. Call may not complete.
Dialing	GSR 56 is dialing the number.
Incoming Call	GSR 56 is receiving a call.
Hanging Up	GSR 56 is disconnecting from the call.
Unavailable	GSR 56 is not usable by the Iridium phone system.

## Suppress Visuals

### FEATURE LIMITATIONS

- *Applicable only to calls using the Iridium telephone system*



Enabling this function inhibits visual indications of incoming calls and text messages.

Tap **Phone > Suppress Visuals**, and select from the following options.

#### Off

No suppression. You may transmit and receive calls normally through the Iridium phone.

#### On

Suppression active. Incoming call/text pop-up indication will not resume until you turn suppression off.

#### On During APR/MAPR/TERM

Suppression active during approach, missed approach, and terminal operations only.

### Suppression does not affect:

- Audible indications (i.e., phone ringer, incoming SMS chime)
- Outgoing calls
- Answering incoming calls

Garmin recommends inhibiting audio from GSR 56 when the Iridium phone is not in use.

## In-Call Distribution

### FEATURE REQUIREMENTS

- *GMA 35 Audio Panel*

Distribute telephone audio to selected crew and/or passenger positions. These include:

- Pilot
- Co-Pilot
- Passenger

You may toggle the telephone audio off to any position at any time.

## Outgoing Calls

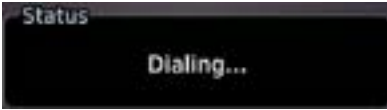

Call someone directly or dial an existing contact in your contact list.

### MAKE A CALL

Tap **Phone** > **Phone Number**.

From here you have the following options:

- *Direct dial a number:* Type the number you wish to call and then tap **Enter**.
- *Dial an existing contact:* Tap **Contacts**, select a name from the list, then tap **Call**.

To cancel the call, tap **End Call**.

### DATA ENTRY



If it is necessary to enter data during a call (e.g., an automated phone menu prompts you to make a numeric selection), tap **Touchtone Entry** and enter the value using the provided keypad.



## Incoming Calls



Incoming calls generate a status message. Options allow you to accept or ignore the call.

### ACCEPT A CALL

Tap **Answer**. Status window shows the call as “Connected” and the cumulative call timer begins.

Upon accepting a call, you have the following options.

- *Adjust call volume:* Use volume controls to set the level according to preference.
- *Distribute telephone audio:* Select **Pilot**, **Co-Pilot**, and/or **Passenger**.
- *Hang up:* Tap **End Call**.

### IGNORE A CALL

Tap **Ignore**. This disconnects the call (i.e., hangs up).

# SMS Text



Send and receive text messages via phone or email through your GSR 56 phone connection.

## WHERE TO FIND IT

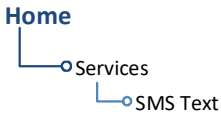

Message tabs allow for management of all incoming and outgoing messages. Each tab displays a message list.

Notations indicate the status of messages within each list. The total number of messages announces at the bottom of the pane.



- |               |  |
|---------------|--|
| <b>Inbox</b>  | Lists up to 250 received messages.           |
| <b>Drafts</b> | Lists all saved outgoing messages.           |
| <b>Outbox</b> | Lists all sent messages pending transmittal. |

## MESSAGE ICONS & NOTATIONS



**TXing**  
Draft message  
pending transmittal



**Sent**  
Sent message  
(outbox)



**New**  
New message  
(inbox)



**Send/Resend**  
Send message



**Open**  
Message has been  
read



**Failed**  
Failed to send

## Message Filtering & Setup Options

### SMS Text Messaging Menu

- Time
- Address
- Mark All As Read
- Delete All Messages
- Suppress Visuals
  - Off
  - On
  - On During APR/MAPR/TERM

Tap **Menu** to access SMS text messaging filtering and setup options.

- Sort messages according to time or address
- Suppress incoming call indications
- Mark or delete all messages

<b>Sort Messages By Time</b>	Organize messages according to time. The most recent entry appears at the top of the list.
<b>Sort Messages By Address</b>	Organize messages according to address. Entries are listed in alphabetical order.
<b>Mark All As Read</b>	Mark all inbox messages as read.
<b>Delete All Messages</b>	Remove all messages from each tab simultaneously. This command requires user confirmation.
<b>Suppression</b>	Enable/disable the suppression function. Options: Off, On, On During APR/MAPR/TERM

## Send a Text Message



Compose and send a new text message via telephone or email.



1. Tap **Compose**.
2. Select the message destination:  
Tap **To**, then choose either **Phone Number** or **Email Address**.
3. Specify the recipient's phone number or email address. For existing contacts, tap **Contact** and select the recipient's name from the list.
4. Tap **Message** and then type the message content.

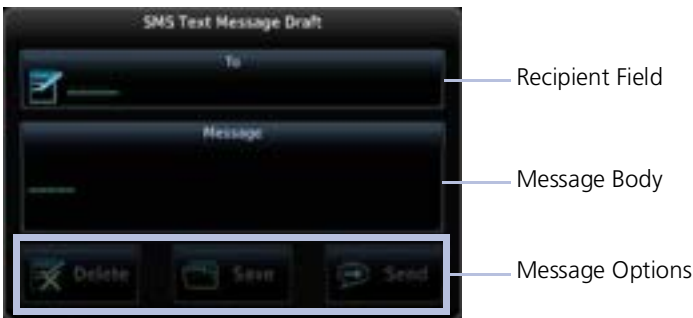

### Draft Message Options

- Delete
- Save
- Send

Once you begin to compose your message, you have the following options:

- *Delete the unsent message:* Tap **Delete**.
- *Save the message as a draft:* Tap **Save**.
- *Send the message:* Tap **Send**.

Once sent, the message automatically appears in your outbox. Pending messages remain in your outbox until they complete transmittal.

### Sent Message Options

- Delete
- Save Contact
- Send Again

Open a sent message if you wish to:

- *Delete it from your outbox:* Tap **Delete**.
- *Save the phone number or email address:* Tap **Save Contact** and enter the new contact name.
- *Resend after it failed to send on the first attempt:* Tap **Send Again**.

## MESSAGE FAILED TO SEND



Failed messages remain in the outbox until they are resent or deleted. The number of failed messages announces below the tab name.



### To resend the message:

Select the message from the outbox list, then tap **Send Again**.

If the message fails to send, you can tap **Delete** to remove it from the list.

## Receiving Text Messages

To view a new text message, tap **Inbox** and select the message from the list.

### Received Message Options

- Delete
- Save Contact
- Reply

All received messages allow the following options:

- *Delete the message from your inbox:* Tap **Delete**.
- *Add the sender to your contact list:* Tap **Save Contact** and enter the new contact name.
- *Compose a response:* Tap **Reply**.

# Position Reports



Enable automatic GPS-referenced position reports for continuous monitoring of aircraft status while en route. This function collects system variables and transmits them at predefined intervals through the GSR 56.

## WHERE TO FIND IT



Set the report function to transmit automatically based on a schedule of your choice, or send a report immediately by tapping **Send Report**.

## Position Reporting Status Annunciations

Position reporting enables when the aircraft is in the air. A window displays the status of GSR 56 functions.



ANNUNCIATION	MEANING
Idle	GSR 56 reporting function is not in use.
Idle - On Ground	GSR 56 reporting function is not in use. Aircraft is on the ground.
Initializing	GSR 56 and its driver are initializing.
Transferring	GSR 56 is transmitting a position report.
Unavailable	GSR 56 is not usable by the reporting system.

### GSR 56 Product Information Reporting:

Once GTN powers up, it takes 90 seconds for the GSR 56 to report its serial number. During this period, GSR 56 product information status shows as *Waiting*.

## Counters & Timers

### Time Until Transmit

- Countdown timer
- Shows time remaining until the next data transmission
- Dashes indicate when the aircraft is on the ground

### Reports in Queue

- Counter
- Shows the number of reports waiting in queue

## Position Reporting



Tapping **Automatic Reporting** toggles the automatic position reporting function on or off.

### SPECIFY A REPORT PERIOD

1. Enable automatic reporting.
2. Tap **Report Period** and specify a reporting interval between 2 and 60 minutes.

### SEND A REPORT

1. Disable automatic reporting.
2. Tap **Send Report**.

# Contacts



Store up to 250 contacts. Call by telephone or send text messages via SMS or email.

## WHERE TO FIND IT

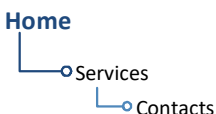

Scroll the list or search by name. Contact names are in alphabetical order.

## Create a Contact



1. Tap **Add**.
2. Enter the contact's name, phone number, and/or email address using the appropriate data entry keys.
3. Tap **Save Contact**.

The new contact appears in the list.



A field in the upper right corner of the page indicates the total number of contacts in the list.

When direct dialing or storing a contact's phone number, dial "1" before the area code and seven-digit telephone number.

1 + area code + seven-digit telephone number

## Find a Contact



1. Tap **Search**.
2. Type the contact's name and tap **Enter**.

The page displays the matching entry.

To return to the full list view, tap **Clear Search**.

## Contact Options



Selecting an existing contact opens a menu. Options allow you to:

- Dial a contact's telephone
- Send a text message via phone or email
- Edit contact information
- Delete a contact from the list

## DELETE A CONTACT

1. Select a name from the contact list.
2. Tap **Delete**.
3. Confirm the request.

INTENTIONALLY LEFT BLANK

# 7 Messages

ADVISORY MESSAGES.....7-2

# Advisory Messages

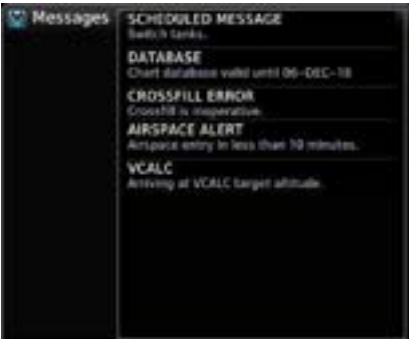

**Message List**

Advisories are system-related messages relative to the display.

- Most recent advisories appear at the top of the message list
- View-once advisories remain in queue until viewed by the pilot
- Persistent (or conditional) advisories remain active until the indicated condition is resolved

## Dual GTN Installations

Advisory messages are not crossfilled between GTN units. Each unit displays messages based on the data it receives. This may result in duplicate messages between units. Always view the messages on both GTNs to ensure that all information is received.

## Message Key

This key displays in the unit's control bar when an advisory condition is present. Tapping **MSG** once displays an advisory list. Tapping it again acknowledges all active advisories and closes the list.

The key no longer displays after all active advisories are cleared.



The key flashes when a new advisory is present.



It turns solid once all active advisories are acknowledged.

## Airspace Advisories

Alerted airspace types are based on pilot settings in the Airspace Alerts page. These advisories are informational only. No action is necessary.

ADVISORY	CONDITION
<b>AIRSPACE ALERT</b> Inside airspace.	Aircraft is inside alerted airspace.
<b>AIRSPACE ALERT</b> Airspace within 2 nm and entry in less than 10 minutes.	Alerted airspace is within 2 nm of the path and projected to enter in less than 10 minutes.
<b>AIRSPACE ALERT</b> Airspace entry in less than 10 minutes.	Aircraft is projected to enter alerted airspace in less than 10 minutes.
<b>AIRSPACE ALERT</b> Within 2 nm of airspace.	Alerted airspace is less than 2 nm from the aircraft. May not be projected to enter the airspace.

# Database Advisories

ADVISORY	CONDITION	CORRECTIVE ACTION
<b>CROSSFILL ERROR</b> GTN Navigation DB mismatch.	Navigation databases do not match between GTNs resulting in a loss of communication between the two units.	Verify that the database version specified by both GTNs is up to date. Update the database if needed.
<b>DATABASE</b> Terrain or Obstacle database not available.	The Terrain or Obstacle database is missing or corrupt.	Re-download and install the indicated database. Contact a Garmin dealer for support.
<b>DATABASE</b> Terrain display unavailable for current location.	Terrain/TAWS function unavailable. Terrain database cannot provide elevation at the current GPS position. Aircraft is outside the database coverage area.	Load appropriate coverage area onto the external datacard.
<b>DATABASE</b> Verify user-modified procedures in stored flight plans are correct.	Navigation database updates and the stored flight plan contains user-modified procedures.	Verify the procedures are correct.
<b>DATABASE</b> Verify airways in stored flight plan are correct.	The stored flight plan contains an airway that is inconsistent with the current navigation database.	Verify all airways are correct. If necessary, reload airways to the stored flight plan routes.
<b>DATABASE</b> A procedure has been modified in a cataloged flight plan.	Database update causes flight plan to exceed 100 waypoint limit. Procedure is removed or truncated as a result.	Verify cataloged flight plan and procedures are correct. If necessary, reload procedures to the stored flight plan routes.
<b>DATABASE</b> Chart database valid until [date].	The charts database is approaching expiration.	Verify expiration date: Home > <b>System</b> > <b>System Status</b> > <b>Active</b> tab If available, load the next cycle of the charts database into standby.
	The charts database is expired.	Update the database if necessary for operation.

ADVISORY	CONDITION	CORRECTIVE ACTION
<p><b>DATABASE</b> Chart function unavailable.</p>	<p>Charts database verification failure.</p>	<p>Re-download and install the indicated database. Contact a Garmin dealer for support.</p>
<p><b>DATABASE</b> Chart database incomplete. Some charts may be unavailable.</p>	<p>Charts database verification failure.</p>	<p>Re-download and install the indicated database. Contact a Garmin dealer for support.</p>
<p><b>DATABASE</b> Terrain database is not installed, is corrupt, or is not valid for this system.</p>	<p>Terrain database is not available at system startup. Terrain information and alerts do not display. The database may be corrupt, not present, or not authorized for the unit.</p>	<p>Re-load the database on the external datacard.</p>
<p><b>DATABASE</b> Chart Streaming unavailable. Using installed chart database from datacard.</p>	<p>Chart streaming not available. GTN reverted to the currently installed charts.</p>	<p>Open the System Status page and check database synchronization status. If the problem persists, contact a Garmin dealer for support.</p>
<p><b>DATABASE</b> SYNC in progress. View System Status page for more info.</p>	<p>Database synchronization is in progress.</p>	<p>Wait for database synchronization to complete. Restart GTN to use new databases.</p>
<p><b>MAGNETIC VARIATION</b> Aircraft in area with large mag var. Verify all course angles.</p>	<p>Magnetic variation flagged as unreliable in the MagVar database. Typically occurs when operating at high latitudes that do not support a magnetic NAV angle.</p>	<p>Verify that the geographical region supports navigation based on magnetic variation.</p>

## Datalink Advisories

ADVISORY	CONDITION	CORRECTIVE ACTION
<b>DATALINK</b> ADS-B In fault: UAT receiver.	ADS-B In source detects a UAT receiver fault.	Service required. Contact dealer for support.
<b>DATALINK</b> ADS-B In fault: 1090 receiver.	ADS-B In source detects a 1090 receiver fault.	
<b>DATALINK</b> FIS-B weather has failed.	FIS-B receiver reports a failure. FIS-B products may not display.	
<b>DATALINK</b> GDL 69 is inoperative or connection to GTN is lost.	GTN loses communication with GDL 69/69A. Datalink data not available.	<ol style="list-style-type: none"> <li>1. Close the GDL 69/69A circuit breaker.</li> <li>2. Verify that the GDL 69/69A unit is receiving power.</li> <li>3. Ensure the aircraft has a clear view of the sky.</li> <li>4. Verify subscription status is active (Home &gt; <b>System</b> &gt; <b>External LRUs</b>, locate GDL 69/69A and tap <b>More Info</b>).</li> <li>5. Contact dealer for service.</li> </ol>

ADVISORY	CONDITION	CORRECTIVE ACTION
<p><b>DATALINK</b> GDL 88 ADS-B failure. Unable to transmit ADS-B messages.</p>	<p>GDL 88 cannot transmit the ADS-B message due to an internal failure or an antenna failure.</p>	<p>Service required. Contact dealer for support.</p>
<p><b>DATALINK</b> GDL 88 ADS-B fault.</p>	<p>GDL 88 detects a fault with one of the UAT/1090 antennas.</p>	
<p><b>DATALINK</b> GDL 88 ADS-B fault. Pressure altitude input is invalid.</p>	<p>GDL 88 loses communication with the pressure altitude source.</p>	
<p><b>DATALINK</b> GDL 88 ADS-B is not transmitting position. Check GPS devices.</p>	<p>GDL 88 detects a position input fault.</p>	
<p><b>DATALINK</b> GDL 88 configuration module needs service.</p>	<p>GDL 88 detects a configuration module fault.</p>	
<p><b>DATALINK</b> GDL 88 control input fault. Check transponder is in correct mode.</p>	<p>GDL 88 loses communication with the transponder.</p>	<p>Service required. Contact dealer for support.</p>
<p><b>DATALINK</b> GDL 88 is inoperative or connection to GTN is lost.</p>	<p>GTN loses communication with the datalink device (GDL 88). Traffic and/or FIS-B weather data not available.</p>	
<p><b>DATALINK</b> GDL 88 needs service.</p>	<p>GDL 88 reports an internal fault.</p>	

ADVISORY	CONDITION	CORRECTIVE ACTION
<p><b>DATALINK</b> GSR 56 data services inoperative; registration required.</p>	<p>GSR 56 requires registration. The following GSR services are not available:</p> <ul style="list-style-type: none"> <li>• Weather</li> <li>• Position Reporting</li> <li>• Phone</li> </ul>	<ol style="list-style-type: none"> <li>1. Register the GSR 56.</li> <li>2. Activate a Connex subscription.</li> <li>3. Contact dealer for service.</li> </ol>
<p><b>DATALINK</b> GSR 56 is inoperative or connection to GTN is lost.</p>	<p>GTN loses communication with GSR 56. The following GSR services are not available:</p> <ul style="list-style-type: none"> <li>• Weather</li> <li>• Position Reporting</li> <li>• Phone</li> </ul>	<ol style="list-style-type: none"> <li>1. Close the GSR 56 circuit breaker.</li> <li>2. Verify that the GSR 56 unit is receiving power.</li> <li>3. Contact dealer for service.</li> </ol>

# Flight Plan Advisories

ADVISORY	CONDITION	CORRECTIVE ACTION
<p><b>FLIGHT PLAN IMPORT</b></p> <p>Flight plan import failed.</p>	<p>Unit unable to decode flight plan contents. Wireless import of the requested flight plan not possible.</p>	<p>Check for proper operation of all necessary components. If the problem persists, contact dealer for service.</p>
<p><b>FLIGHT PLAN IMPORT</b></p> <p>Flight plan import failed. Catalog is full.</p>	<p>The flight plan catalog is full. Wireless import of the requested flight plan not possible.</p>	<p>Delete any unnecessary flight plans from the catalog.</p>
<p><b>FLIGHT PLAN IMPORT</b></p> <p>New imported flight plan(s) available for preview.</p>	<p>Unit receives the specified number of flight plans via the import function. They are available for viewing on the Preview page.</p>	<p>No action necessary.</p>
<p><b>FLIGHT PLAN IMPORT</b></p> <p>Changes to active route are disabled.</p>	<p>Unit receives a flight plan from G3X Touch, but the External FPL Crossfill function is off.</p>	<p>Service required. Contact dealer for support.</p>
<p><b>FLIGHT PLAN IMPORT</b></p> <p>GDU disconnected. External flight plan crossfill inoperative.</p>	<p>Unit loses communication with the G3X Touch.</p>	<p>Verify that the GDU is on. Contact dealer for service.</p>
<p><b>FPL WAYPOINT LOCKED</b></p> <p>Stored flight plan waypoint is not in current navigation database.</p>	<p>Current navigation database no longer contains a stored flight plan waypoint.</p>	<p>Verify all stored cataloged flight plans and procedures. Modify stored flight plans as necessary to include waypoints that are in the current navigation database.</p>
<p><b>FPL WPT MOVED</b></p> <p>Stored flight plan waypoint has changed location.</p>	<p>A waypoint in a stored flight plan moved by more than 0.33 arc minutes from its previous position.</p>	<p>Verify stored cataloged flight plans and procedures. Modify stored flight plans as necessary to include waypoints that are in the current navigation database.</p>

ADVISORY	CONDITION	CORRECTIVE ACTION
<p><b>LOCKED FLIGHT PLAN</b> Cannot activate a flight plan containing a locked waypoint.</p>	<p>User is attempting to activate a flight plan that contains a locked waypoint.</p>	<p>Modify flight plan as necessary to include waypoints, procedures, and airways that are in the navigation database.</p>
<p><b>OBS</b> OBS is not available due to dead reckoning or no active waypoint.</p>	<p>OBS not supported in dead reckoning mode. Requires an active waypoint.</p>	<p>No action necessary.</p>
<p><b>PARALLEL TRACK</b> Parallel track not supported for leg type.</p>	<p>Parallel track not supported on active leg type.</p>	
<p><b>PARALLEL TRACK</b> Parallel track not supported for turns greater than 120 degrees.</p>	<p>Parallel track not supported for turns greater than 120 degrees due to the acute angle.</p>	
<p><b>PARALLEL TRACK</b> Parallel track not supported past IAF.</p>	<p>Parallel track not supported on approaches.</p>	
<p><b>STEEP TURN</b> Steep turn. Aircraft may overshoot course during turn.</p>	<p>The flight plan contains an acute course change ahead. Following the guidance requires a bank in excess of normal. If coupled, the autopilot may not be able to execute the steep turn.</p>	<p>Slowing the aircraft may shallow the turn.</p>

# GPS/WAAS Advisories

ADVISORY	CONDITION	CORRECTIVE ACTION
<p><b>GPS NAVIGATION LOST</b> Insufficient satellites. Use other navigation source.</p>	<p>GPS position lost due to lack of satellites.</p>	<p>Wait for GPS satellite geometry to improve. Ensure the aircraft has a clear view of the sky. Use a different GPS receiver or a non-GPS based source of navigation. Contact dealer for service.</p>
<p><b>GPS NAVIGATION LOST</b> Erroneous position. Use other navigation source.</p>	<p>GPS position lost due to erroneous position.</p>	<p>Use a different GPS receiver or a non-GPS based source of navigation. Contact dealer for service.</p>
<p><b>GPS RECEIVER</b> Low internal clock battery.</p>	<p>GPS receiver indicates that its clock battery is low. May experience delay when attempting to acquire GPS position. Almanac data may be lost.</p>	<p>Contact dealer for service.</p>
<p><b>GPS RECEIVER</b> GPS receiver needs service.</p>	<p>GPS receiver reports that it requires service. GPS module functionality may be unavailable.</p>	<p>Use a different GPS receiver or a non-GPS based source of navigation. Contact dealer for service.</p>
<p><b>GPS RECEIVER</b> GPS receiver has failed. Check GPS coax for electrical short.</p>	<p>Internal communication to the GPS receiver is inoperative.</p>	<p>Use a different GPS receiver or a non-GPS based source of navigation. Contact dealer for service.</p>
<p><b>GPS SEARCHING SKY</b> Ensure GPS antenna has unobstructed view of the sky.</p>	<p>GPS receiver is acquiring position and may take longer than normal. Typically occurs when the unit is powered on after installation or being off for several weeks.</p>	<p>No action necessary.</p>
<p><b>LOSS OF INTEGRITY (LOI)</b> Verify GPS position with other navigation equipment.</p>	<p>GPS board reports LOI. Antenna may be shaded from satellites.</p>	<p>Ensure the aircraft is clear of hangars, buildings, trees, etc. Use a different GPS receiver or a non-GPS based source of navigation. If the problem persists, contact dealer for service.</p>

# Navigation Advisories

ADVISORY	CONDITION	CORRECTIVE ACTION
<p><b>ABORT APPROACH</b> GPS approach is no longer available.</p>	GPS approach not available. GPS unable to provide approach level of service (i.e., LPV, LNAV, LNAV+V, or L/VNAV).	Initiate a climb to the MSA or other published safe altitude, abort the approach, and execute a non-GPS based approach.
<p><b>APPROACH DOWNGRADE</b> GPS approach downgraded. Use LNAV minima.</p>	Approach downgraded from LPV or LNAV/VNAV to an LNAV approach. Vertical guidance no longer available.	Continue to fly the approach using published LNAV minimums.
<p><b>APPROACH NOT ACTIVE</b> Approach guidance not available.</p>	GPS approach could not transition to active (e.g., the unit remains in TERM as it does not have the required HPL/VPL for LNAV).	Abort the approach and then execute a non-GPS based approach.
<p><b>CDI/HSI FLAG</b> Main lateral/vertical flag on CDI/HSI is inoperative.</p>	Main Lateral/Vertical Superflag output is off due to an overcurrent condition.	Verify course guidance is valid and correct by crosschecking the unit's on-screen CDI with other navigational equipment. Contact dealer for service.
<p><b>CDI SOURCE</b> Select appropriate CDI source for approach.</p>	<p>Aircraft is on a GPS approach, but CDI is set to VLOC.</p> <p>Aircraft is on VLOC approach, CDI is set to GPS, and aircraft is less than 2 nm from the FAF.</p>	Select the appropriate CDI source for the approach.
<p><b>HOLD EXPIRED</b> Holding EFC time has expired.</p>	It is past the specified Expected Further Clearance time for the user-defined hold.	No action necessary. Consider contacting ATC as appropriate.
<p><b>MAGNETIC NORTH APPROACH</b> Verify NAV angles are referenced to Magnetic north.</p>	The loaded approach is magnetic, but the NAV angle reference is not.	Change NAV angle setting to Magnetic.

ADVISORY	CONDITION	CORRECTIVE ACTION
<p><b>NAV ANGLE</b> NAV angles are referenced to True north (T).</p>	NAV angle is set to True.	No action necessary.
<p><b>NAV ANGLE</b> NAV angles are referenced to a user set value (U).</p>	NAV angle is set to User.	
<p><b>NON-WGS84 WAYPOINT</b> Location may be different than where surveyed for &lt;WPT&gt;.</p>	The active waypoint does not reference the WGS84 datum.	No action necessary. For more information, read “Points About Non-WGS84 Waypoints” in this section.
<p><b>SELECT FREQUENCY</b> Select appropriate NAV frequency for approach.</p>	The active NAV frequency is not correct for the approach procedure.	Enter the correct frequency into the active NAV frequency window.
<p><b>SET COURSE</b> Set Course on CDI/HSI to &lt;current DTK&gt;.</p>	The selected course on the CDI/HSI does not match the current desired track.	Set the CDI/HSI selected course to the current desired track.
<p><b>TOD/BOD</b> in 1 minute.</p>	Aircraft will reach top/bottom of descent in 1 minute.	No action necessary.
<p><b>TRUE NORTH APPROACH</b> Verify NAV angles are referenced to True north (T).</p>	The loaded procedure references True north and the active leg has a published True north reference.	Verify the NAV angle is set to True north.
<p><b>VISUAL APPROACH NOT ACTIVE</b> Approach guidance not available when direct-to runway.</p>	A direct course was created to the runway waypoint. Approach guidance not available.	Reactivate the approach or cancel the direct course.
<p><b>VNAV</b> Unable to reach vertical waypoint.</p>	Altitude constraint cannot be reached based on current ground and vertical speeds.	Attempt to intercept vertical path by adjusting aircraft altitude.

ADVISORY	CONDITION	CORRECTIVE ACTION
<p><b>VNAV</b> Unavailable. Upcoming flight plan leg not supported.</p>	<p>The lateral flight plan contains a procedure turn, vector, or other unsupported leg type prior to the active vertical waypoint.</p>	<p>Treat the flight plan segments before and after the affected leg as separate vertical profiles. GTN cannot provide automatic guidance between the two segments.</p>
<p><b>VNAV</b> Unavailable. Excessive cross track error.</p>	<p>Crosstrack exceeds limit, causing vertical path guidance to become invalid.</p>	<p>Navigate within 10 nm of flight plan centerline, or edit flight plan to allow for vertical navigation.</p>
<p><b>VNAV</b> Unavailable. Excessive track angle error.</p>	<p>Track angle error exceeds limit, causing vertical path guidance to become invalid.</p>	<p>Navigate within 70° of active flight plan course.</p>
<p><b>VNAV</b> Unavailable. Parallel course selected.</p>	<p>Selecting a parallel course causes vertical path guidance to become invalid.</p>	<p>Disable parallel track if vertical path guidance is preferred.</p>
<p><b>VNAV</b> Unavailable. Barometric altitude lost.</p>	<p>A loss of data from the barometric altitude sensor causes vertical path guidance to become invalid.</p>	<p>Contact dealer for support.</p>
<p><b>WAYPOINT</b> Arriving at [wpt name].</p>	<p>Pilot set the arrival alarm and is within the specified distance.</p>	<p>Informational only. No action necessary.</p>

### Points About Non-WGS84 Waypoints

- There are several types of geodetic datums that a waypoint can reference.
- TSO-C 146 requires that all waypoints reference the WGS84 datum, but allows for navigation to coordinates not compliant with this standard as long as the pilot is notified of the potential difference in location.
- Not all waypoints in the navigation database reference the WGS84 datum. For some of these coordinates the reference datum is unknown. In such cases, the “Non-WGS84 Waypoint” advisory displays.
- Garmin cannot determine the exact proximity of a non-compliant waypoint to the WGS84 datum in use by the system. Typically, the distance is < 2 nm.
- Most non-WGS84 waypoints are outside of the United States.

## Pilot Specified Advisories

These advisories display when the associated timer expires or reaches a preset value. They are informational only. Other than acknowledging the message, no action is necessary.

ADVISORY	CONDITION
<b>SCHEDULED MESSAGE</b> <Text>.	The custom message timer expired.
<b>TIMER</b> Timer has expired.	The generic timer is past its preset value.

## System Hardware Advisories

ADVISORY	CONDITION	CORRECTIVE ACTION
<p><b>APR GUIDANCE AVAILABLE</b></p> <p>Press "Enable APR Output" before selecting APR on autopilot.</p>	Approach guidance is available and waiting for pilot acknowledgement.	Before engaging approach mode on the autopilot, tap the <b>Enable APR Output</b> key.
<p><b>AUDIO FAIL</b></p> <p>Aural alerts unavailable. GTN needs service.</p>	GTN is unable to play audio for alerts.	Contact dealer for service.
<p><b>CONFIGURATION MODULE</b></p> <p>GTN configuration module needs service.</p>	GTN cannot communicate with its configuration module. Unit configuration may still be valid.	Contact dealer for service.
<p><b>COOLING</b></p> <p>GTN over temp. Reducing backlight brightness.</p>	Unit temperature exceeds the over temperature threshold. Backlight dims to reduce power and heat.	Decrease cabin temperature and increase cabin airflow near the unit. If the problem persists, contact dealer for service.
<p><b>COOLING FAN</b></p> <p>The cooling fan failed.</p>	The unit's cooling fan is not turning at the required RPM. Backlight may dim to reduce power and heat.	Extended operation at high temperatures is not recommended as damage to the unit may occur. Contact dealer for service.
<p><b>CROSSFILL ERROR</b></p> <p>GTN software mismatch.</p>	Crossfill function is on, but not working due to a software mismatch.	Contact dealer for software update.
<p><b>CROSSFILL ERROR</b></p> <p>Crossfill is inoperative.</p>	The unit lost communication with the other GTN.	Contact dealer for service.
	One GTN requires service.	
<p><b>CROSSFILL STATUS</b></p> <p>Crossfill is turned off.</p>	Crossfill function is off.	No action necessary. To re-enable, open the System Setup page and toggle the associated function key on.

ADVISORY	CONDITION	CORRECTIVE ACTION
<p><b>DATA LOST</b> Pilot stored data was lost. Recheck settings.</p>	<p>An error occurred in the pilot stored data. The following user settings may be lost.</p> <ul style="list-style-type: none"> <li>• Alert settings</li> <li>• Map menu settings</li> <li>• User waypoints</li> <li>• Catalog flight plans</li> <li>• User field settings</li> <li>• Unit convention selection</li> </ul>	<p>Recheck settings.</p>
<p><b>DATACARD ERROR</b> SD card is invalid or failed.</p>	<p>The SD card has an error and is unreadable.</p>	<ol style="list-style-type: none"> <li>1. Reformat the SD card using an external computer.</li> <li>2. Re-insert the SD card in the slot.</li> <li>3. Contact dealer if the problem persists.</li> </ol>
<p><b>DATACARD REMOVED</b> Reinsert SD card.</p>	<p>The external SD card was removed.</p>	<p>Reinsert SD card.</p>
<p><b>DATA SOURCE</b> Heading source inoperative or connection to GTN lost.</p>	<p>GTN is not receiving heading information from any source. Heading up map orientation not available.</p>	<p>Contact dealer for service.</p>
<p><b>DATA SOURCE</b> Pressure altitude source inoperative or connection to GTN lost.</p>	<p>GTN is not receiving pressure altitude data from any source.</p> <p><b>NOTE:</b> A transponder receiving pressure altitude data from GTN will not receive pressure altitude while this condition is present.</p>	
<p><b>DATA SOURCE</b> Radar Altimeter source inoperative or connection to GTN lost.</p>	<p>GTN is not receiving radio altitude information from any source.</p> <p>50 foot VCO aural alert not available. (HTAWS installations only).</p>	

ADVISORY	CONDITION	CORRECTIVE ACTION
<p><b>DEMO MODE</b> Demo mode is active. Do not use for navigation.</p>	<p>The unit is in demo mode. Do not use for actual navigation.</p>	<p>Power cycle the unit to exit demo mode. Verify that the <b>Direct To</b> key is not stuck.</p>
<p><b>GTN</b> GTN needs service.</p>	<p>Loss of factory calibration data.</p>	<p>Contact dealer for service.</p>
<p><b>INTERFACE ADAPTER</b> GAD 42 configuration needs service.</p>	<p>GAD 42 reports a configuration error.</p>	<p>Verify all input/output data to/from the adapter. Contact dealer for service.</p>
<p><b>INTERFACE ADAPTER</b> GAD 42 needs service.</p>	<p>GAD 42 reports it needs service. Functionality may be unavailable.</p>	
<p><b>INTERNAL SD CARD ERROR</b> GTN needs service.</p>	<p>The unit's internal SD card has an error. This card is not accessible by the user.</p>	<p>Contact dealer for service.</p>
<p><b>INTERNAL SD CARD REMOVED</b> GTN needs service.</p>	<p>The internal SD card has been removed from the unit or it has experienced a failure.</p>	
<p><b>KEY STUCK</b> &lt;Name&gt; key is stuck.</p>	<p>System detects the indicated bezel key is depressed for at least 30 seconds. It will now ignore this input.</p>	<p>Push the indicated key again. If it remains stuck, contact dealer for service.</p>
<p><b>KNOB STUCK</b> &lt;Dual concentric inner/Volume&gt; knob is stuck in the pressed position.</p>	<p>System detects the indicated knob is depressed for at least 30 seconds. It will now ignore this input.</p>	<ul style="list-style-type: none"> <li>• Push the knob again. If it remains stuck, use the corresponding touchscreen controls.</li> <li>• Contact dealer if the problem persists.</li> </ul>

ADVISORY	CONDITION	CORRECTIVE ACTION
<p><b>&lt;NAME&gt; LOG EXPORT</b> &lt;Name&gt; log export failed.</p>	<p>Export failure. May occur for GPS receiver diagnostic or flight data logs.</p>	<ol style="list-style-type: none"> <li>1. Reformat the SD card using an external computer.</li> <li>2. Re-insert the SD card in the slot.</li> <li>3. Contact dealer if the problem persists.</li> </ol>
<p><b>&lt;NAME&gt; LOG EXPORT</b> &lt;Name&gt; log export complete.</p>	<p>Export to SD card successful. Occurs for GPS receiver diagnostic and flight data logs.</p>	<p>No action necessary.</p>
<p><b>REMOTE KEY STUCK</b> Remote &lt;Name&gt; key is stuck.</p>	<p>System detects the indicated remote key is depressed for at least 30 seconds. It will now ignore this input.</p>	<p>Push the indicated remote key again. If it remains stuck, contact dealer for service.</p>

## Audio Panel Advisories

**AVAILABLE WITH:  
GTN 725Xi/750Xi**

ADVISORY	CONDITION	CORRECTIVE ACTION
<p><b>AUDIO PANEL</b> Audio panel needs service.</p>	<p>GMA 35 is reporting that it requires service. Functionality may be unavailable.</p>	<p>Service required. Contact dealer for support.</p>
<p><b>AUDIO PANEL</b> Audio panel is inoperative or connection to GTN is lost.</p>	<p>Unit loses communication with GMA 35. Audio panel control is not possible.</p>	<p>Remove power from GMA 35 by pulling the Audio circuit breaker. Maintain communication using the COM 2 radio. Contact dealer for support.</p>
<p><b>REMOTE KEY STUCK</b> Pilot/Co-pilot voice command push-to-command key is stuck.</p>	<p>System detects the key depressed for at least 30 seconds. It will now ignore the input signal. This input is not available on all installations.</p>	<p>Press the key again. If it remains stuck, contact dealer for service.</p>

## COM Radio Advisories

**AVAILABLE WITH:  
GTN 635Xi/650Xi/750Xi**

ADVISORY	CONDITION	CORRECTIVE ACTION
<p><b>COM RADIO</b> COM radio needs service.</p>	<p>COM radio is reporting that it requires service. Functionality may be unavailable.</p>	<p>Cycle radio power. Contact dealer for service.</p>
<p><b>COM RADIO</b> COM radio may be inoperative.</p>	<p>COM radio is not communicating with the unit.</p>	<p>Push and hold volume knob or external com remote transfer switch (if installed) to force the radio to 121.5 MHz. Contact dealer for service.</p>
<p><b>COM RADIO</b> COM overtemp or undervoltage. Reducing transmitter power.</p>	<p>COM radio is in overtemp or undervoltage mode. Transmitting power automatically reduces to prevent damage to the com radio. Radio range is reduced as a result.</p>	<ul style="list-style-type: none"> <li>• Decrease length of com transmissions</li> <li>• Decrease cabin temperature and increase cabin airflow, especially near the unit</li> <li>• Check aircraft voltage and reduce electrical load as necessary</li> <li>• Contact dealer for service if message persists</li> </ul>
<p><b>COM RADIO</b> COM locked to 121.5 MHz. Hold remote com transfer key to exit.</p>	<p>COM radio is locked to 121.5 MHz via the external com remote transfer switch.</p>	<p>Hold remote transfer switch for two seconds to exit mode.</p>

ADVISORY	CONDITION	CORRECTIVE ACTION
<p><b>REMOTE KEY STUCK</b> COM &lt;Name&gt; key is stuck.</p>	<p>Unit detects the specified key in the pressed position for 30 seconds. The input is ignored as a result. Radio stops transmitting.</p> <p>Includes:</p> <ul style="list-style-type: none"><li>• Push-to-talk key</li><li>• Remote transfer key</li><li>• Remote frequency increment key</li><li>• Remote frequency decrement key</li></ul>	<p>Verify that the key is not stuck. Contact dealer for service if message persists.</p>

## XPDR Advisories

ADVISORY	CONDITION	CORRECTIVE ACTION
<b>TRANSPONDER 1/2</b> ADS-B is not transmitting position.	Transponder is not receiving valid GPS position data. Unable to support ADS-B.	Ensure the aircraft has a clear view of the sky. If the problem persists, contact dealer for service.
<b>TRANSPONDER 1/2</b> ADS-B Out system fault. Pressure altitude source inoperative or connection lost.	Transponder loses communication with the pressure altitude source.	Contact dealer for service.
<b>TRANSPONDER 1/2</b> Transponder has failed.	Transponder detects an internal failure. Functionality may be unavailable.	
<b>TRANSPONDER 1/2</b> Transponder 1/2 needs service.	The transponder is reporting that it needs service. Functionality may be unavailable.	Verify squawk code and altitude with ATC. Contact dealer for service.
<b>TRANSPONDER 1/2</b> Transponder 1/2 is inoperative or connection to GTN is lost.	GTN is unable to communicate with the configured transponder.	Verify squawk code and altitude with ATC. Contact dealer for service.
<b>TRANSPONDER 1/2</b> Transponder 1/2 is operating in ground test mode.	Transponder is operating in a mode intended for ground testing.	Cycle power to the transponder once ground test completes.
<b>TRANSPONDER1/2</b> Transponder overtemp.	Transponder reports that its internal temperature exceeds the over temperature threshold.	Decrease cabin temperature and increase cabin airflow near the transponder. If the problem persists, contact dealer for service.
<b>TRANSPONDER 1/2</b> Transponder under temp.	Transponder reports that its internal temperature is below the normal operating threshold.	If the problem persists, contact dealer for service.

# Terrain Advisories

ADVISORY	CONDITION	CORRECTIVE ACTION
<p><b>CONFIGURATION</b> TAWS/Terrain configuration is invalid. GTN needs service.</p>	<p>Terrain/TAWS alerting inoperative due to a unit configuration problem. Message accompanied by the "TER FAIL" annunciation.</p>	<p>Service required. Contact dealer for support.</p>
<p><b>HTAWS</b> Invalid Terrain Database.</p>	<p>Terrain database resolution does not support HTAWS (rotorcraft only).</p>	<p>Load rotorcraft specific terrain database from the external SD card.</p>
<p><b>HTERRAIN ALERTING</b> Invalid Terrain Database.</p>	<p>Terrain database resolution does not support the current terrain alerting configuration (rotorcraft only).</p>	
<p><b>TAWS/TERRAIN AUDIO INHIBITED</b> TAWS/Terrain audio inhibit input is stuck.</p>	<p>The alerting system's audio inhibit discrete input is active for at least 30 seconds. Alerts may be heard simultaneously with other audio alerts.</p>	<p>Contact dealer for support.</p>

# Traffic System Advisories

ADVISORY	CONDITION	CORRECTIVE ACTION
<b>TRAFFIC</b> ADS-B In traffic alerting has failed.	ADS-B traffic system reports a CSA failure. Functionality not available.	Ensure that the aircraft has a clear view of the sky. If the problem persists, contact dealer for service.
<b>TRAFFIC</b> ADS-B In traffic has failed.	ADS-B traffic system detects an internal fault.	Contact dealer for support.
	ADS-B traffic system has lost GPS position.	
<b>TRAFFIC</b> ADS-B In traffic source does not match configuration.	The primary ADS-B traffic source is not available. GTN is relying on data from backup source.	
<b>TRAFFIC</b> Traffic device has failed.	GTS reports a device failure.	
<b>TRAFFIC</b> Traffic device is inoperative or connection to GTN is lost.	GTN is not receiving data from the configured traffic device.	
<b>TRAFFIC</b> TAS/TCAS inoperative or connection to GTN is lost.	TAS/TCAS device reports a traffic failure.	Reset the TCAS device. Contact dealer for support.
	GTN loses communication with the TAS/TCAS device.	
<b>TRAFFIC</b> Traffic device has been in standby for more than 60 seconds.	GTN is airborne; traffic device in standby > 60 seconds.	If traffic alerts are desired, open the Traffic app and enable the operating mode of the traffic device: <b>Home &gt; Traffic &gt; Menu &gt; Operate</b>
<b>TRAFFIC</b> TCAD has a low battery.	GDL 88 reports that the external traffic system has a low battery.	Contact dealer for support.

ADVISORY	CONDITION	CORRECTIVE ACTION
<p><b>TRAFFIC</b> Traffic device battery low. Traffic device user config settings not saved.</p>	<p>The TCAD system indicates a low battery.</p>	<p>Contact dealer for support.</p>

## VCALC Advisories

ADVISORY	CONDITION	CORRECTIVE ACTION
<p><b>VCALC</b> Approaching top of descent.</p>	<p>User configured a vertical descent calculation, and the aircraft is within 60 seconds of the calculated top of descent.</p>	<p>No action necessary.</p>
<p><b>VCALC</b> Arriving at VCALC target altitude.</p>	<p>User configured a vertical descent calculation, and the aircraft is approaching target altitude.</p>	

## VLOC/GS Advisories

ADVISORY	CONDITION	CORRECTIVE ACTION
<p><b>GLIDESLOPE</b> Glideslope receiver needs service.</p>	<p>Glideslope board is reporting that it requires service. Functionality may be unavailable.</p>	<p>Verify glideslope deviation indications with another source and cross-check final approach fix crossing altitude. If another source is not available, fly a GPS based approach. Contact dealer for service.</p>
<p><b>VOR/LOC/GS RECEIVER</b> Navigation receiver has failed.</p>	<p>NAV radio is not communicating with the system. VOR, LOC, and GS are inoperative.</p>	<p>Use GPS based navigation. Contact dealer for support.</p>
<p><b>VLOC RECEIVER</b> Navigation receiver needs service.</p>	<p>NAV radio is reporting that it requires service. Functionality may be unavailable.</p>	<p>Service required. Contact dealer for support.</p>

# Waypoint Advisories

ADVISORY	CONDITION	CORRECTIVE ACTION
<b>GNS CROSSFILL</b> Catalog full; not all GNS waypoint(s) transferred.	User waypoint catalog is full. Import of the requested user waypoints could not complete.	Delete any unnecessary user waypoints from the catalog and try again.
<b>GNS CROSSFILL</b> GTN user waypoint(s) replaced with GNS user waypoints.	A user waypoint from the GNS unit replaces one or more existing waypoints on GTN.	Avoid overwriting existing waypoints by ensuring that all requested user waypoints have unique identifiers prior to transfer.
<b>GNS CROSSFILL</b> Waypoint transfer failed.	Waypoint transfer did not complete.	Reattempt data transfer.
<b>MARK ON TARGET</b> Waypoint creation has failed. MOT requires GPS position.	MOT waypoint creation failed due to missing GPS position.	<ul style="list-style-type: none"> <li>• Wait for GPS satellite geometry to improve</li> <li>• Ensure that the aircraft has a clear view of the sky</li> <li>• Reattempt waypoint creation</li> <li>• Contact dealer for support</li> </ul>
<b>USER WAYPOINT IMPORT</b> User waypoint import failed.	User waypoint import failed due to improper file format.	Verify that media has the correct file format. If the problem persists, contact dealer for service.
<b>USER WAYPOINT IMPORT</b> User waypoint import failed. User waypoint database is full.	User waypoint catalog is full. Import of the requested user waypoints could not complete.	Delete any unnecessary user waypoints from the catalog and try again.
<b>USER WAYPOINT IMPORT</b> User waypoints were imported successfully.	User waypoint import successful.	No action necessary.

ADVISORY	CONDITION	CORRECTIVE ACTION
<p><b>USER WAYPOINT IMPORT</b></p> <p>User waypoints imported successfully - existing waypoints reused.</p>	<p>User waypoint import successful. Import function reuses existing user waypoints instead of creating duplicates.</p>	<p>No action necessary.</p>

## Weather Service Advisories

ADVISORY	CONDITION	CORRECTIVE ACTION
<p><b>WX ALERT</b></p> <p>Possible severe weather.</p>	<p>Weather radar detects the presence of a weather alert within +/- 10 degrees of the aircraft heading.</p>	<p>To view information about severe weather in the current flight path, open the Radar app: Home &gt; <b>Weather</b> &gt; <b>Radar</b></p>
<p><b>WX RADAR FAIL</b></p> <p>Weather radar is inoperative.</p>	<p>GTN is not receiving weather radar data.</p>	<p>Contact dealer for support.</p>
<p><b>WX RADAR SERVICE</b></p> <p>Weather radar needs service. Return unit for repair.</p>	<p>Weather radar reports that a degraded or inoperative condition exists.</p> <p>Appears only when the aircraft is on ground.</p>	<p>Service required. Contact dealer for support.</p>
<p><b>STORMSCOPE</b></p> <p>Stormscope is inoperative or connection to GTN is lost.</p>	<p>GTN is not receiving data from the Stormscope unit.</p>	<ol style="list-style-type: none"> <li>1. Close the Stormscope circuit breaker.</li> <li>2. Verify that the Stormscope unit is receiving power.</li> <li>3. Contact dealer for support.</li> </ol>
<p><b>STORMSCOPE</b></p> <p>Invalid heading received from Stormscope.</p>	<p>Stormscope reports an invalid heading source.</p>	<p>Stormscope data is correct and safe for use. Contact dealer for support.</p>

INTENTIONALLY LEFT BLANK

# 8 Qualification

GLOVE QUALIFICATION .....8-2  
VOICE COMMAND QUALIFICATION .....8-6



**NOTE**

*The procedures described in this section are not authorized for completion during flight. All tasks must be performed while the aircraft is on the ground.*

# Glove Qualification

The touchscreen uses capacitive touch technology to sense the proximity of skin to the display. A glove creates a barrier between the skin and the display glass, potentially reducing the ability of the display to detect touches.

This procedure qualifies a specific glove for use with the touchscreen. Due to differences in finger size and glove size, the qualification procedure is specific to the pilot/glove and GTN combination. Multiple units must be evaluated individually.

## GLOVE SELECTION CONSIDERATIONS

- Thinner gloves perform better than thicker gloves.
- Leather gloves, and gloves designed specifically for use with capacitive touchscreen devices, are often found to be acceptable.
- To improve touchscreen sensitivity while wearing gloves, use the pad of your finger instead of the tip during touch interactions.

## GLOVE QUALIFICATION GUIDANCE

- Checklist 1 contains the tasks required to qualify a glove.
- Checklist 2 contains tasks that are not required to qualify a glove, but may limit how some functions are accessed while wearing a glove.

## GLOVE QUALIFICATION STEPS

Complete only the tasks for the capabilities relevant to the installed navigator.

1. Sitting in the pilot's seat, start the unit in demo mode (press and hold the **Direct To** key during power up).
2. Perform the tasks presented in each checklist, tapping the specified keys with a non-gloved finger. It is not necessary to record any results for this step.
3. Repeat step 2 using a gloved hand.
4. For each task, determine whether the touchscreen response is the same or worse than without the glove.
5. Record the results in the applicable column. Items that may cause the operation to be worse include, but are not limited to:
  - Multiple attempts to select a key
  - Unintentional selection of adjacent key(s)
  - Excessive force on the touchscreen to select a key
6. If all applicable tasks produce the same response with and without a glove, you may use the glove in flight.

## GLOVE QUALIFICATION PROCEDURE

Pilot: \_\_\_\_\_

Glove Description: \_\_\_\_\_

Circle the applicable navigator.

GTN 625Xi

GTN 635Xi

GTN 650Xi

GTN 725Xi

GTN 750Xi

### CHECKLIST 1: REQUIRED TASKS

TASK	OPERATION WITH GLOVE (circle one)	
<i>Starting from the Home page:</i>		
1. Tap <b>Demo &gt; GPS &gt; Waypoint.</b>	Same	Worse
2. Type the airport identifier "KSLE" and tap <b>Enter.</b>	Same	Worse
3. Return to the Home page.	Same	Worse
4. Tap <b>Flight Plan &gt; Add Waypoint.</b>	Same	Worse
5. Type the airport identifier "KSLE" and tap <b>Enter.</b>	Same	Worse
<i>Add each of the following waypoints in the same manner.</i>		
6. KMMV	Same	Worse
7. KONP	Same	Worse
8. BTG	Same	Worse
9. Select <b>BTG.</b>	Same	Worse
10. Tap <b>Load Airway &gt; V23 &gt; ALFOR &gt; Load.</b>	Same	Worse
11. Scroll the list of flight plan waypoints up and down, then tap <b>Back.</b>	Same	Worse
<b>GTN 635Xi/650Xi/750Xi ONLY</b>		
12. Select the COM <b>STBY</b> frequency window.	Same	Worse
13. Type a valid frequency and tap <b>Enter.</b>	Same	Worse
14. Select the active <b>COM</b> frequency window. Observe: active and standby frequency values swap positions.	Same	Worse
<b>GTN 650Xi/750Xi ONLY</b>		
15. Select the active <b>NAV</b> frequency field. Observe: active and standby frequency values swap positions.	Same	Worse

## CHECKLIST 2: NON-REQUIRED TASKS

TASK		OPERATION WITH GLOVE (circle one)	
<i>Starting from the Home page:</i>			
1.	Tap <b>Flight Plan</b> .	Same	Worse
2.	With one finger on the page, drag the waypoint list up and down, then tap <b>Back</b>	Same	Worse
3.	Tap <b>Map</b> .	Same	Worse
4.	Tap the map display and select <b>Graphically Edit FPL</b> .	Same	Worse
5.	Drag KONP to an empty area of the map, panning and zooming as necessary. Observe: KONP is removed from the flight plan.	Same	Worse
6.	Drag the leg between KMMV and BTG to KSPB. Observe: KSPB is added to the flight plan.	Same	Worse

# Voice Command Qualification

## Qualification Procedure Requirements

- GMA 35/350
- Valid GPS position
- Aviation headset and MIC
- English proficiency

This procedure qualifies the Telligence Voice Command voice recognition feature for use by the pilot and/or copilot.

Crew members must be proficient in English and comfortable with speaking into an aviation headset.

## ACCEPTANCE CRITERIA

Minimum passing score: **85%** (17 out of 20)

Allowable number of attempts: **1**

## VOICE COMMAND GUIDELINES

- Position headset MIC approximately 1/8" away from mouth. Align with bottom lip to avoid breathing into the microphone.
- Review commands before performing the qualification.
- Enunciate each word, maintaining a normal tone, volume, and cadence.
- After activating the **PTC** switch, pause briefly before speaking the command.

If	Then
The command is uninterpretable	Verify that the system is performing the intended action or displaying the appropriate data
The system does not recognize the command	Use the touchscreen controls to execute the function
The total number of successful commands is less than 17	Disable the voice command feature

A list of all performed commands is available in the Voice Command History. From the Home page, tap **System > Voice Commands > Command History**.

## ALTERNATE COMMANDS

Not all features listed in this qualification may pertain to your aircraft's configuration. Speak the alternate phrase if the initial command is not applicable to your system.

Example: The command is "Toggle COM 2," but the unit is not equipped with a COM radio. In this case, speak the alternate command: "Say distance."

## VOICE COMMAND QUALIFICATION

1. Start the unit in normal mode and acquire a GPS position.
2. Perform checklist tasks in the order presented. For each task:
  - Push and hold **PTC** switch.
  - Speak the provided command and then release switch. For commands pertaining to non-applicable features, speak the alternate command.
  - Listen for the audible tone.
3. Record the result in the provided column.

For audible tone definitions and feature activation/deactivation steps, refer to Voice Commands in section 2.

## CHECKLIST: VOICE COMMANDS

	TASK	RESULT (circle one)	
1.	<b>Speak:</b> Show Flight Plan page. <b>Then:</b> Manually enter a towered airport as the destination.	Pass	Fail
2.	<b>Speak:</b> Show Trip Planning page.	Pass	Fail
3.	<b>Speak:</b> Tune nearest ground. <sup>[1]</sup> <b>Alternate:</b> Show Nearest Airport page.	Pass	Fail
4.	<b>Speak:</b> Tune nearest ATIS. <sup>[1]</sup> <b>Alternate:</b> Show nearest weather frequency page.	Pass	Fail
5.	<b>Speak:</b> Toggle Com 2. <sup>[2]</sup> <b>Alternate:</b> Say distance.	Pass	Fail
6.	<b>Speak:</b> Show Map page.	Pass	Fail
7.	<b>Speak:</b> Zoom out.	Pass	Fail
8.	<b>Speak:</b> Say distance to destination.	Pass	Fail
9.	<b>Speak:</b> Show Flight Timers page.	Pass	Fail
10.	<b>Speak:</b> Select Com 2. <sup>[2]</sup> <b>Alternate:</b> Say ETA at destination.	Pass	Fail
11.	<b>Speak:</b> Say active waypoint.	Pass	Fail
12.	<b>Speak:</b> Create waypoint here.	Pass	Fail
13.	<b>Speak:</b> Tune destination tower. <sup>[1]</sup> <b>Alternate:</b> Show Destination Runways page.	Pass	Fail
14.	<b>Speak:</b> Show Traffic page. <sup>[3]</sup> <b>Alternate:</b> Show Nearest page.	Pass	Fail
15.	<b>Speak:</b> Show Procedures page.	Pass	Fail
16.	<b>Speak:</b> Show V-CALC page. <b>Alternate:</b> Show VNAV page.	Pass	Fail
17.	<b>Speak:</b> Show current time.	Pass	Fail
18.	<b>Speak:</b> Say desired track.	Pass	Fail
19.	<b>Speak:</b> Back.	Pass	Fail
20.	<b>Speak:</b> Show Voice Command History page.	Pass	Fail

[1] Requires GTN COM radio feature.

[2] Requires two COM radios connected to the GMA.

[3] Requires traffic capability on GTN.

# 9 Practice

DEMO MODE ..... 9-2

# Demo Mode



GTN provides a demonstration (or *demo*) mode that allows simulation of all operations while on the ground. Enable this mode when you want to familiarize yourself with the unit controls.



## WARNING

**NEVER USE GTN FOR NAVIGATION WHEN DEMO MODE IS ACTIVE. DEMO MODE IS FOR LEARNING PURPOSES ONLY. IT IS NOT FOR USE IN THE AIR.**

## Enable Demo Mode



While the aircraft is on ground:

1. Push and hold the **Direct To** key.
2. With the key depressed, apply power to the GTN.

The unit powers up in demo mode. A dedicated start-up screen presents a caution message.

Tapping **Continue** advances to the normal mode start-up screens.

During demo mode, the Home page has the appearance of being in normal mode with two notable exceptions:



A **Demo** key provides access to mode setup options. This key resides in the unit's control bar.



An active mode indication appears in the annunciator bar.

# Demo Setup Options



Tapping **Demo** opens the Demo Setup page.

## Demo Setup

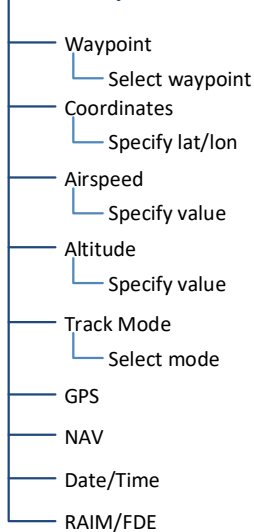

Options allow you to specify GPS position and other parameters so that you may practice navigating with the unit.

Advanced settings for GPS, navigation, date, and time are accessible via the respective page access keys.

<b>GPS Position</b>	<b>Waypoint</b>	Set GPS position by selecting a waypoint.
	<b>Coordinates</b>	Set GPS position by specifying the lat/lon coordinates.
<b>NAV</b>	<b>Airspeed</b>	Specify the value for true airspeed.
	<b>Altitude</b>	Specify the value for altitude.
	<b>Track Mode</b>	Select the track mode. Options include: <ul style="list-style-type: none"> <li>• Flight plan</li> <li>• Flight Plan + Vertical</li> <li>• Manual</li> </ul>
<b>Advanced Settings</b>	<b>GPS</b>	Access advanced GPS settings.
	<b>NAV</b>	Access advanced navigation settings.
	<b>Date/Time</b>	Access date and time settings.

## Advanced Settings



- Solution
  - Select type
- Coordinates
  - Specify lat/lon
- Waypoint
  - Select waypoint
- HPL FD
  - Adjust value
- HPL WAAS
  - Adjust value
- VPL WAAS
  - Adjust value



- Airspeed
  - Specify value
- Vertical Speed
  - Specify value
- Altitude
  - Specify value
- Track Mode
  - Select mode
- Time Scale
  - Select scale



- Date
  - Specify date
- Time
  - Set time

### Position Error Values

You may adjust position error values to reflect errors induced by naturally occurring conditions. These values are not normally adjusted for most demo mode operations. Values include:

- Horizontal protection levels for fault detection and SBAS
- Vertical protection levels for SBAS

# 10 Glossary

## A

ACT	Altitude Compensated Tilt
ADAHRS	Air Data/Attitude & Heading Reference System
ADC	Air Data Computer
ADF	Automatic Direction Finder
ADIZ	Air Defense Identification Zone
ADS-B	Automatic Dependent Surveillance Broadcast
AFM	Aircraft Flight Manual
AFMS	Aircraft Flight Manual Supplement
AGL	Above Ground Level
AHRS	Attitude Heading Reference System
AIM	Aeronautical Information Manual
AIRB	Basic Airborne Application
AIRMET	Airman's Meteorological Information
ALT	Altitude Hold
AP	Autopilot
APR	Approach
APT	Airport
ARINC	Aeronautical Radio Incorporated
ARTCC	Air Route Traffic Control Center
AR	Approval Required
ASOS	Automated Service Observing System
ATAS	ADS-B Traffic Advisory System
ATC	Air Traffic Control
ATIS	Automatic Terminal Information Service
ATK	Along Track
AWOS	Automated Weather Observing Station

### B

BRG Bearing

### C

CDI Course Deviation Indicator

CDU Control and Display Unit

CNXT Connex

CRS Course

CTAF Common Traffic Advisory Frequency

CUM Cumulative

### D

DALT Density Altitude

DB Database

DEST Destination

DFLT Default

DG Directional Gyro

DIS Distance

DME Distance Measuring Equipment

DPRT Departure

DTK Desired Track

### E

EDR Excessive Descent Rate

EFC Expected Further Clearance

EGNOS European Geostationary Navigation Overlay Service

ENR En Route

ESA En Route Safe Altitude

ESP Electronic Stability and Protection

ETA Estimated Time of Arrival

ETE Estimated Time En Route

**F**

FAA	Federal Aviation Administration
FAF	Final Approach Fix
FCC	Federal Communication Commission
FDC	Flight Data Center
FIS-B	Flight Information Services Broadcast
FLTA	Forward Looking Terrain Avoidance
FMS	Flight Management System
FPL	Flight Plan
FREQ	Frequency
FSS	Flight Service Station

**G**

GAGAN	GPS-aided GEO Augmented Navigation
GCS	Ground Clutter Suppression
GDC	Garmin Air Data Computer
GDL	Garmin Data Link
GDU	Garmin Display Unit
GFC	Garmin Flight Controller
GMA	Garmin Marker Beacon Audio
GMU	Garmin Magnetometer Unit
GP	Glidepath
GPS	Global Positioning System
GPSS	Global Positioning System Steering
GRS	Garmin Reference System
GS	Glideslope
GSL	Geometric Sea Level
GSU	Garmin Sensing Unit
GTP	Garmin Temperature Probe
GTX	Garmin Transponder

### H

HDG	Heading
HOT	Hazardous Obstacle Transmission
HPL	Horizontal Protection Level
HSDB	High Speed Data Bus
HSI	Horizontal Situation Indicator
HTAWS	Helicopter Terrain Awareness and Warning System

### I

IAF	Initial Approach Fix
IAS	Indicated Airspeed
IAT	Induction Air Temperature
IFR	Instrument Flight Rules
ILI	Imminent Line Impact
ILS	Instrument Landing System
INT	Intersection
IOI	Imminent Obstacle Impact
ISA	International Standard Atmosphere
ITI	Imminent Terrain Impact

### K

KIAS	Knots Indicated Airspeed
------	--------------------------

### L

LCD	Liquid Crystal Display
LDI	Lateral Deviation Indicator
LOA	Letter of Authorization
LOC	Localizer
LOI	Loss of Integrity
LPV	Localizer Performance with Vertical Guidance
LRU	Line Replaceable Unit

**M**

MAG VAR	Magnetic Variation
MAP	Missed Approach Point
MAHP	Missed Approach Holding Point
MDA	Minimum Descent Altitude
METAR	Meteorological Terminal Aviation Routine Weather Report
MGRS	Military Grid Reference System
MOA	Military Operations Area
MOT	Mark on Target
MSA	Minimum Safe Altitude
MSAS	MTSAT Satellite Augmentation System
MSG	Message
MSL	Mean Sea Level

**N**

NAV	Navigation
NAVAID	Navigation Aid
NCR	Negative Climb Rate
NDB	Non-Directional Beacon
NEXRAD	Next-Generation Radar

**O**

OAT	Outside Air Temperature
OBS	Omni Bearing Selector
OCN	Oceanic

**P**

PCL	Pilot Controlled Lighting
PDA	Premature Descent Alert
PVT	Position, Velocity, and Time

### R

RA	Resolution Advisory
RAIM	Receiver Autonomous Integrity Monitoring
RF	Radius to Fix
RLC	Reduced Line Clearance
RNAV	Area Navigation
RNP	Required Navigation Performance
ROC	Reduced Required Obstacle Clearance
RTC	Reduced Required Terrain Clearance

### S

SAR	Search and Rescue
SAT	Static Air Temperature
SBAS	Satellite Based Augmentation System
SBS	Surveillance and Broadcast Services
SD	Secure Digital
SIGMET	Significant Meteorological Information
SSID	Service Set Identifier
STAR	Standard Terminal Arrival
STBY	Standby
SUA	Special Use Airspace
SURF	Surface Situation Awareness
SUSP	Suspend
SVID	Satellite-Vehicle Identification

**T**

T	True
TA	Traffic Advisory
TACAN	Tactical Air Navigation System
TAF	Terminal Aerodrome Forecast
TAS	Traffic Advisory System True Airspeed
TAT	Total Air Temperature
TAWS	Terrain Awareness and Warning System
TCA	Terminal Control Area
TCAD	Traffic Alert and Collision Avoidance Devices
TCAS	Traffic Alert and Collision Avoidance System
TCH	Threshold Crossing Height
TERM	Terminal
TFR	Temporary Flight Restriction
TIS	Traffic Information Service
TMA	Terminal Maneuvering Area
TRK	Track
TRSA	Terminal Radar Service Area
TSAA	Traffic Situational Awareness with Alerting
TSO	Technical Standard Order

**U**

UPS	Universal Polar Stereographic Grid
USR	User
UTC	Universal Time Coordinated
UTM	Universal Transverse Mercator

### V

VCALC	Vertical Calculator
VDI	Vertical Deviation Indicator
VFR	Visual Flight Rules
VHF	Very High Frequency
VLOC	VOR/Localizer
VNAV	Vertical Navigation
VOR	Very High Frequency Omnidirectional Range
VORTAC	Very High Frequency Omnidirectional Range Station and Tactical Air Navigation
VPL	Vertical Protection Level
VRP	Visual Reporting Point
VS	Vertical Speed
VSI	Vertical Speed Indicator

### W

WAAS	Wide Area Augmentation System
WGS84	World Geodetic System 1984
WPT	Waypoint
WX	Weather

### X

XPDR	Transponder
XTK	Cross Track

# 11 Regulatory Information

COMPLIANCE..... 11-2

SOFTWARE LICENSE AGREEMENT ..... 11-3

# Compliance

## FCC Compliance Statement

This device complies with Part 15 of the FCC limits for Class B digital devices. This equipment generates, uses, and can radiate radio frequency energy and, if not installed and used in accordance with the instructions, may cause harmful interference to radio communications. Furthermore, there is no guarantee that interference will not occur in a particular installation.

If this equipment does cause harmful interference, the user is encouraged to try to correct the interference by relocating the equipment or connecting the equipment to a different circuit than the affected equipment. Consult an authorized dealer or other qualified avionics technician for additional help if these remedies do not correct the problem.

Operation of this device is subject to the following conditions: (1) This device may not cause harmful interference, and (2) this device must accept any interference received, including interference that may cause undesired operation.

## AC 90-100A Statement of Compliance

The Garmin navigational unit meets the performance and functional requirements of FAA Advisory Circular (AC) 90-100A, *U.S. Terminal and En Route Area Navigation (RNAV) Operations*.

# Software License Agreement

BY USING THE DEVICE, COMPONENT OR SYSTEM MANUFACTURED OR SOLD BY GARMIN ("THE GARMIN PRODUCT"), YOU AGREE TO BE BOUND BY THE TERMS AND CONDITIONS OF THE FOLLOWING SOFTWARE LICENSE AGREEMENT. PLEASE READ THIS AGREEMENT CAREFULLY. Garmin Ltd. and its subsidiaries ("Garmin") grants you a limited license to use the software embedded in the Garmin Product (the "Software") in binary executable form in the normal operation of the Garmin Product. Title, ownership rights, and intellectual property rights in and to the Software remain with Garmin and/or its third-party providers. You acknowledge that the Software is the property of Garmin and/or its third-party providers and is protected under the United States of America copyright laws and international copyright treaties. You further acknowledge that the structure, organization, and code of the Software are valuable trade secrets of Garmin and/or its third-party providers and that the Software in source code form remains a valuable trade secret of Garmin and/or its third-party providers. You agree not to reproduce, decompile, disassemble, modify, reverse assemble, reverse engineer, or reduce to human readable form the Software or any part thereof or create any derivative works based on the Software. You agree not to export or re-export the Software to any country in violation of the export control laws of the United States of America.

INTENTIONALLY LEFT BLANK



